

Operating Instructions

P2PY107

Laser Distance Sensor Time of Flight



EN



Table of Contents

1	General	4
1.1	Information Concerning these Instructions.....	4
1.2	Explanation of Symbols.....	4
1.3	Limitation of Liability.....	5
1.4	Copyrights.....	5
2	For Your Safety	6
2.1	Use for Intended Purpose.....	6
2.2	Use for Other than the Intended Purpose.....	6
2.3	Personnel Qualifications.....	6
2.4	Modification of Products.....	7
2.5	General Safety Precautions	7
2.6	Laser Warnings	7
2.7	Approvals and protection classes.....	7
3	Technical Data	9
3.1	General Information.....	9
3.1.1	Light spot diameter.....	10
3.1.2	Switching Distance Deviation.....	10
3.2	Warm-Up Phase	10
3.3	Working Range	11
3.4	Mode-Dependent Data.....	11
3.5	Housing Dimensions	12
3.6	Control panel.....	12
3.7	Complementary Products	12
4	Transport and Storage	13
4.1	Transport	13
4.2	Storage	13
5	Installation and Electrical Connection	14
5.1	Installation	14
5.2	Electrical Connection	14
5.3	Diagnosis	15
5.4	Troubleshooting	15
6	Settings	17
6.1	Configuration with Push of Button / Teach-In	17
7	Function Description	19
7.1	Sensor Functions.....	19
7.2	Pin Function	21
7.2.1	Output Functions.....	22
7.2.2	Input Functions.....	22
7.2.3	Switching Point Functions (SSC1/SSC2).....	22
7.2.4	Condition Monitoring Functions	24
7.2.5	Simulation Functions	25
7.3	Condition Monitoring/Process Data.....	26
7.3.1	Process Data In.....	26
7.3.2	Process Data Out.....	27
7.3.3	Events.....	27
8	wTeach2 Configuration Software	28

9 Maintenance Instructions 29
10 Proper Disposal 30
11 Declarations of Conformity..... 31

1 General

1.1 Information Concerning these Instructions

- It ensures safe and efficient use of the product.
- This manual is part of the product and must be retained for the entire service life.
- In addition, local accident prevention regulations and national occupational safety regulations must be observed.
- The product is subject to technical development, so the instructions and information in these operating instructions are also subject to change. You can find the current version at www.wenglor.com in the product's download section.



INFORMATION

The operating instructions must be read carefully before use and kept for future reference.

1.2 Explanation of Symbols

- Safety precautions and warnings are emphasized by means of symbols and signal words.
- Safe use of the product is only possible if these safety precautions and warnings are adhered to.

The safety precautions and warnings are laid out in accordance with the following principle:

SIGNAL WORD

Type and source of danger!

Possible consequences in the event that the hazard is disregarded.

→ Measures for averting the hazard.

The meanings of the signal words, as well as the scope of the associated hazards, are listed below:



! DANGER

This signal word indicates a hazard with a high degree of risk which, if not avoided, results in death or severe injury.



! WARNING

This signal word indicates a hazard with a medium degree of risk which, if not avoided, may result in death or severe injury.



! CAUTION

This signal word indicates a hazard with a low degree of risk which, if not avoided, may result in minor or moderate injury.



NOTICE

This signal word draws attention to a potentially hazardous situation which, if not avoided, may result in property damage.



INFORMATION

Information draws attention to useful tips and suggestions, as well as information on efficient, error-free use.

1.3 Limitation of Liability

- The product has been developed in consideration of the current state-of-the-art technology, as well as applicable standards and guidelines. Subject to change without notice.
- A valid declaration of conformity can be accessed at www.wenglor.com in the product's separate download area.
- wenglor sensoric elektronische Geräte GmbH (hereinafter referred to as "wenglor") excludes all liability in the event of:
 - Non-compliance with the instructions
 - Use of the product for purposes other than those intended.
 - Use by untrained personnel.
 - Use of unapproved spare parts.
 - Unapproved modification of products.
- These operating instructions do not include any guarantees from wenglor with regard to the described procedures or specific product characteristics.
- wenglor assumes no liability for printing errors or other inaccuracies contained in these operating instructions unless wenglor was verifiably aware of such errors at the point in time at which the operating instructions were prepared.

1.4 Copyrights

- The contents of these instructions are protected by copyright law.
- All rights are reserved by wenglor.
- Commercial reproduction or any other commercial use of the provided content and information, in particular graphics and images, is not permitted without previous written consent from wenglor.

2 For Your Safety

2.1 Use for Intended Purpose

Laser Distance Sensors ToF

Laser distance sensors Time-of-Flight (ToF) work according to the principle of transit time measurement, which means that they cover large working ranges up to 10,000 mm, so that objects can be reliably detected even at great distances. The ToF sensors are extremely robust against interfering ambient light, which ensures reliable operation.

This Product Can Be Used in the Following Industry Sectors:

- Special-purpose mechanical engineering
- Heavy mechanical engineering
- Logistics
- Automotive industry
- Food industry
- Packaging industry
- Pharmaceuticals industry
- Plastics industry
- Woodworking industry
- Consumer goods industry
- Paper industry
- Electronics industry
- Glass industry
- Steel industry
- Aviation industry
- Chemicals industry
- Alternative energies
- Raw materials extraction

2.2 Use for Other than the Intended Purpose

- Not a safety component in accordance with 2006/42/EC (Machinery Directive).
- The product is not suitable for use in potentially explosive atmospheres.
- The product may be used only with accessories supplied or approved by wenglor, or in combination with approved products. A list of approved accessories and combination products can be found at www.wenglor.com on the product detail page.



DANGER

Risk of personal injury or property damage in case of use for other than the intended purpose!

Use for other than the intended purpose may lead to hazardous situations.

→ Observe instructions regarding use for intended purpose.

2.3 Personnel Qualifications

- Suitable technical training is a prerequisite.
- In-house electronics training is required.
- Trained personnel who use the product must have (permanent) access to the operating instructions.



DANGER

Risk of personal injury or property damage in case of incorrect initial start-up and maintenance!

Personal injury and damage to equipment may occur.

→ Adequate training and qualification of personnel

2.4 Modification of Products



DANGER

Risk of personal injury or property damage if the product is modified!

Personal injury and damage to equipment may occur. Noncompliance may result in loss of the CE and/or UKCA mark and voiding of the warranty.

→ Modification of the product is not permitted

2.5 General Safety Precautions



INFORMATION

These instructions are an integral part of the product and must be kept on hand for the entire duration of its service life.

In the event of possible changes, the current version of the operating instructions can be found at www.wenglor.com in the product's separate download area.

Read the operating instructions carefully before using the product.

Protect the sensor against contamination and mechanical influences.

2.6 Laser Warnings



Laser class 1 (EN 60825-1)

Standards and safety regulations must be observed.

Complies with 21 CFR 1040.10 and 1040.11 except for conformance with IEC 60825-1 Ed. 3., as described in Laser Notice No. 56, dated May 8, 2019.

2.7 Approvals and protection classes

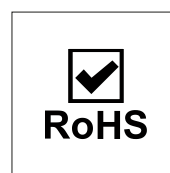
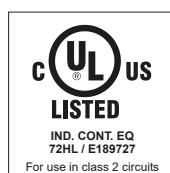
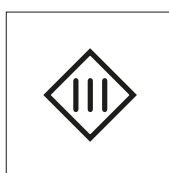



3 Technical Data

3.1 General Information

Optical Data	
Working Range	0...10000 mm
Measuring Range	50...10000 mm
Reproducibility maximum	3 mm
Linearity Deviation	10 mm
Switching Hysteresis	< 15 mm
Light Source	Laser (red)
Wavelength	660 nm
Service Life (T = +25 °C)	100000 h
Laser Class (EN 60825-1)	1
Beam Divergence	< 2 mrad
Max. Ambient Light	100000 Lux
Light Spot Diameter	see Table 1
Reflector required	no
Electrical Data	
Supply Voltage	18...30 V DC
Current Consumption (U _b = 24 V)	< 40 mA
Measuring Rate	100 /s*
Measuring Rate (max.)	500 /s*
Temperature Drift	< 0.4 mm/K
Temperature Range	-40...55 °C
Analog Output	0...10 V
Short Circuit Protection	yes
Reverse Polarity Protection	yes
Overload Protection	yes
Interface	IO-Link V1.1
IO-Link transmission speed	COM3
Protection Class	III
FDA Accession Number	2110079-001
Mechanical Data	
Setting Method	Teach-In
Housing Material	Stainless steel, V4A (1.4404 / 316L)
Optic Cover	Plastic, PMMA
Degree of Protection	IP68 IP69K
Connection	M12 × 1; 5-pin
FDA compliant	yes
Safety-relevant Data	
MTTFd (EN ISO 13849-1)	502.44 a
General Data	
Scope of delivery	1 × BEF-SET-49 mounting set 1 × initial start-up instructions 1 × sensor

General Data	
Approvals	Ecolab FDA compliant
BMECat data	
eCl@ss 5.1.4	27-27-08-01 Optical distance sensor
eCl@ss 6.x	27-27-08-01 Optical distance sensor
eCl@ss 7.0	27-27-08-01 Optical distance sensor
eCl@ss 7.1	27-27-08-01 Optical distance sensor
eCl@ss 8.x	27-27-08-01 Optical distance sensor
eCl@ss 10.0.1	27-27-08-01 Optical distance sensor

* Depends on mode, see table 2

3.1.1 Light spot diameter

Working Distance	0 m	5 m	10 m
Light Spot Diameter	5 mm	10 mm	15 mm

3.1.2 Switching Distance Deviation

Typical characteristic curve based on Kodak white (90% remission).

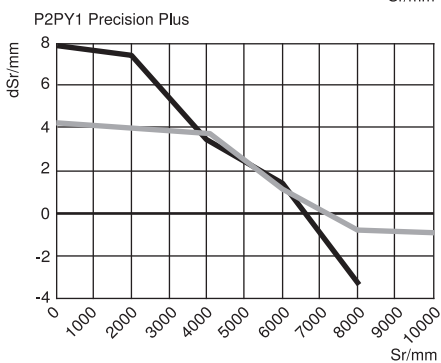
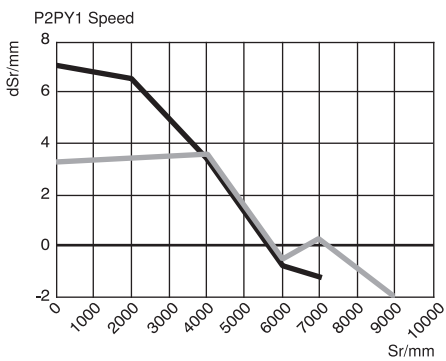

Sr = switching distance

dSr = change in switching distance

Black, 6% remission

Gray, 18% remission

3.2 Warm-Up Phase

The warm-up phase lasts 6 minutes. The switch-on drift during this time is shown in the following diagram.

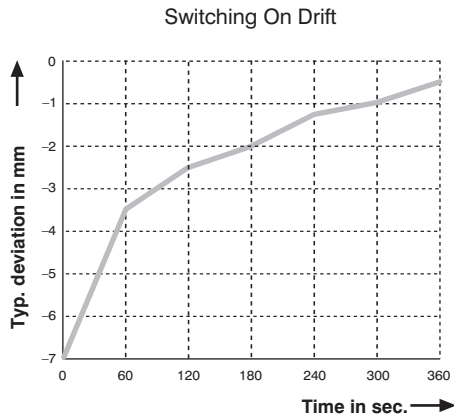

NOTICE

Specifications correspond to measured value without load. With the analog variants, specifications may differ due to the load on the analog output.

3.3 Working Range

The sensor's working range is influenced by two parameters:

- Object remission
- Ambient light

The following values become typical in Precision mode (default):

	ambient light			
remission	100 lux	5,000 lux	20,000 lux	100,000 lux
White (90% remission)	50...10,000 mm	50...10,000 mm	50...10,000 mm	50...10,000 mm
Gray (18% remission)	50...10,000 mm	50...10,000 mm	50...10,000 mm	50...5,000 mm
Black (6% remission)	50...8,000 mm	50...6,500 mm	50...5,500 mm	50...3,000 mm

3.4 Mode-Dependent Data

Some technical data depend on the mode set. Depending on the setting, the following data are obtained:

Mode	Working range	Working range	Working range	Measuring rate	Maximum reproducibility	Linearity deviation	Low signal detection
	White (90% remission)	Gray (18% remission)	Black (6% remission)				
Speed	0...10,000 mm	0...9,000 mm	0...7,000 mm	500/s	5 mm	15 mm	+
Precision (default)	0...10,000 mm	0...10,000 mm	0...8,000 mm	100/s	3 mm	10 mm	++
Precision Plus	0...10,000 mm	0...10,000 mm	0...8,000 mm	50/s	3 mm	10 mm	+++

3.5 Housing Dimensions

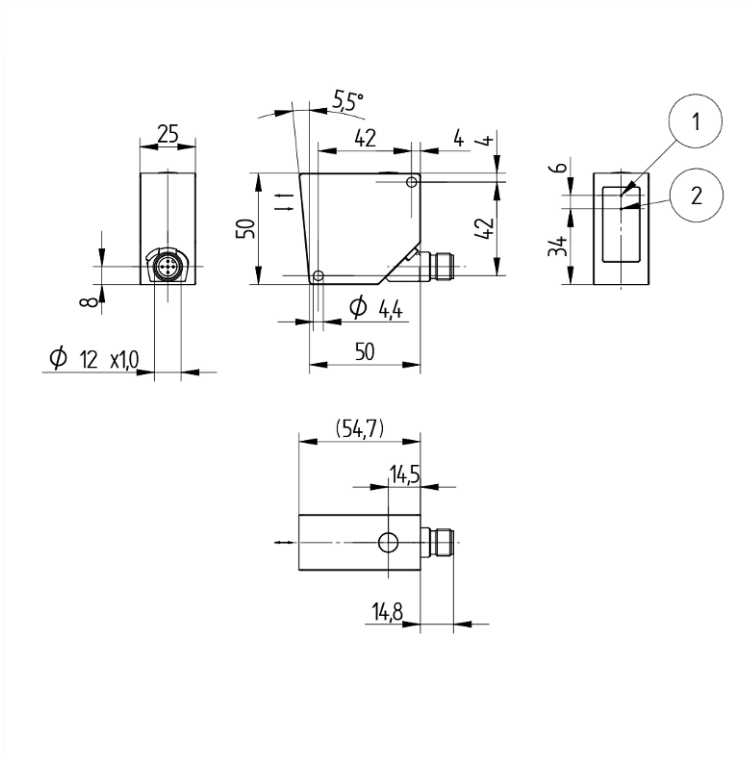

① Transmitter Diode

② Receiver Diode

Screw M4 = 1 Nm

Dimensions in mm (1 mm = 0.03937 inch)

3.6 Control panel

II7

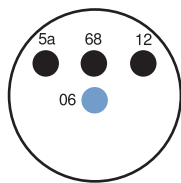

06 = Teach Button

68 = Power LED

5a = Switching Status Indicator, O1

12 = Analog Output Indicator

3.7 Complementary Products

wenglor offers you the right connection and mounting technology as well as other accessories for your product. You can find this at www.wenglor.com on the product details page at the bottom.

4 Transport and Storage

4.1 Transport

Upon receipt of shipment, the goods must be inspected for damage in transit. In the case of damage, conditionally accept the package and notify the manufacturer of the damage. Then return the device, making reference to damage in transit.

4.2 Storage

The following points must be taken into consideration with regard to storage:

- Do not store the product outdoors.
- Store the product in a dry, dust-free place.
- Protect the product against mechanical impacts.
- Protect the product against exposure to direct sunlight.



NOTICE

Risk of property damage in case of improper storage!

The product may be damaged.

→ Storage instructions must be complied with.

5 Installation and Electrical Connection

5.1 Installation

- Protect the product from contamination during installation.
- Relevant electrical and mechanical regulations, standards, and safety rules must be observed.
- Protect the product from mechanical impact.
- Ensure that the sensor is mechanically secure.
- Torque values must be observed (see section Technical Data [► 9]).



NOTICE

Risk of property damage in case of improper installation!

The product may be damaged!

→ Comply with installation instructions.



CAUTION

Risk of personal injury or property damage during installation!

Personal injury and damage to the product may occur.

→ Ensure a safe installation environment.

5.2 Electrical Connection

- Wire the sensor in accordance with the connection diagram.
- Switch on the supply voltage (see section Technical Data [► 9])



DANGER

Risk of personal injury or property damage due to electric current.

Voltage-conducting parts may cause personal injury or damage to equipment.

→ The electric device may be connected by appropriately qualified personnel only.

241

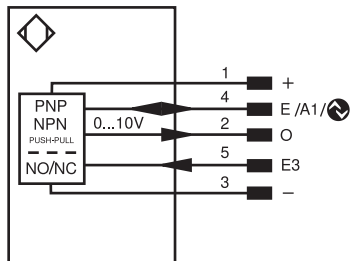

Legend					
+	Supply Voltage +	PT	Platinum measuring resistor	ENARs422	Encoder A/Ā (TTL)
-	Supply Voltage 0 V	nc	Not connected	ENBRs422	Encoder B/B̄ (TTL)
~	Supply Voltage (AC Voltage)	U	Test Input	ENA	Encoder A
A	Switching Output (NO)	Ū	Test Input inverted	ENB	Encoder B
Ā	Switching Output (NC)	W	Trigger Input	AMIN	Digital output MIN
V	Contamination/Error Output (NO)	W-	Ground for the Trigger Input	AMAX	Digital output MAX
Ū	Contamination/Error Output (NC)	O	Analog Output	AOK	Digital output OK
E	Input (analog or digital)	O-	Ground for the Analog Output	SY In	Synchronization In
T	Teach Input	BZ	Block Discharge	SY OUT	Synchronization OUT
R	Reset input	AMv	Valve Output	OLT	Brightness output
Z	Time Delay (activation)	a	Valve Control Output +	M	Maintenance
S	Shielding	b	Valve Control Output 0 V	rsv	Reserved
RxD	Interface Receive Path	SY	Synchronization	Wire Colors according to DIN IEC 60757	
TxD	Interface Send Path	SY-	Ground for the Synchronization	BK	Black
RDY	Ready	E+	Receiver-Line	BN	Brown
GND	Ground	S+	Emitter-Line	RD	Red
CL	Clock	⊥	Grounding	OG	Orange
E/A	Output/Input programmable	SnR	Switching Distance Reduction	YE	Yellow
	IO-Link	Rx+/-	Ethernet Receive Path	GN	Green
PoE	Power over Ethernet	Tx+/-	Ethernet Send Path	BU	Blue
IN	Safety Input	Bus	Interfaces-Bus A(+)/B(-)	VT	Violet
OSSD	Safety Output	La	Emitted Light disengageable	GY	Grey
Signal	Signal Output	Mag	Magnet activation	WH	White
BI_D+/-	Ethernet Gigabit bidirect. data line (A-D)	RES	Input confirmation	PK	Pink
EN0 RS422	Encoder 0-pulse 0/0̄ (TTL)	EDM	Contacting Monitoring	GNYE	Green/Yellow

5.3 Diagnosis

display	Status	Meaning
supply voltage indicator		Sensor ready for operation
P		No voltage supply available
switching status indicator		Switching output active
O1, O2		Warning
		Error
		Switching output not active
Analog display AO		Object within the set measuring range
		Object outside the set measuring range
		Warning
		Error

- = Not lit
- = Flashing
- = Steady

5.4 Troubleshooting

Error	Possible cause	Elimination
Warning	Warning signal	<ul style="list-style-type: none"> • Reduce distance between sensor and object • Adjust angle of sensor to object
	Undervoltage	<ul style="list-style-type: none"> • Increase voltage supply to min. 18 V DC
Error	Short circuit	<ul style="list-style-type: none"> • Check the electrical wiring and eliminate the short circuit
	Temperature error	<ul style="list-style-type: none"> • Disconnect the sensor from the supply voltage and allow it to cool • Mount the mounting bracket as a heat sink • Reduce load on outputs

Error	Possible cause	Elimination
	Device error	<ul style="list-style-type: none"> • Disconnect the sensor from the supply voltage and restart it • Replace the sensor



INFORMATION

Action in case of error:

1. Take the machine out of service.
2. Analyze and rectify the cause of the error using the diagnostic information.
3. If the fault cannot be rectified, contact wenglor support.
4. Do not operate the machine if the error behavior is unclear.
5. The machine must be taken out of service if the error cannot be clearly identified or reliably rectified.



DANGER

Risk of personal injury or property damage if not observed!

The safety function of the system is disabled. Damage to personnel and equipment.

→ Behavior in case of error as specified.

6 Settings

The sensor can be set via the control, IO-Link and wTeach2. The different setting options are outlined below.

6.1 Configuration with Push of Button / Teach-In

This section describes the settings that can be configured directly on the sensor using the button.

Analog Output Function

The sensor outputs its measured value as a linearly proportional current or voltage value. The characteristic curve can be adjusted via teach-in across the entire measuring range.

voltage output:

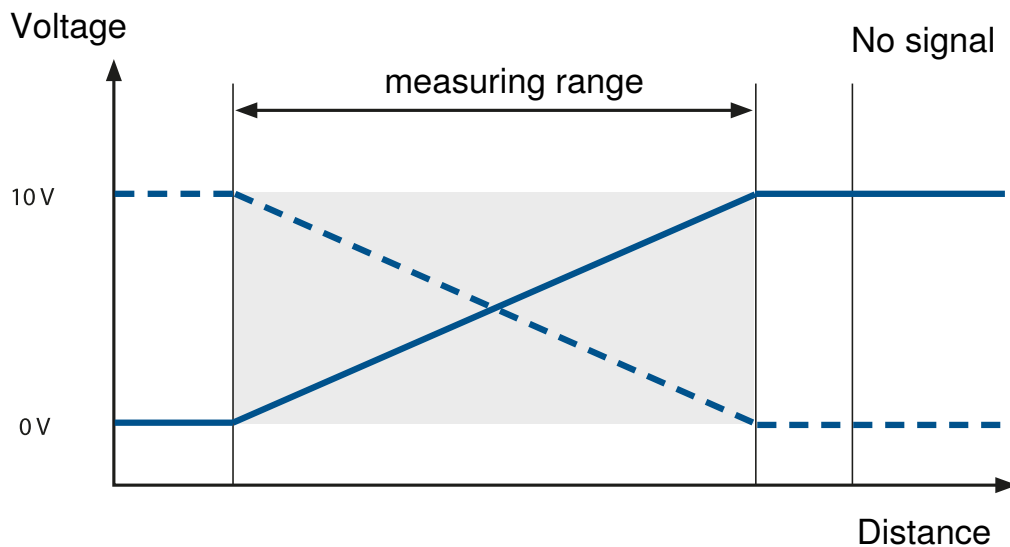

current output:

Substitute Values (Current Output Only)

The sensor is capable of providing a more accurate diagnosis via substitute values to determine whether the analog signal corresponds to a valid measured value within the measuring range.

No signal: 21 mA

Rising characteristic curve

Object outside the measuring range (close): 3.5 mA

Object outside the measuring range, far: 20.5 mA

Declining characteristic curve



Object outside the measuring range (near): 20.5 mA

Object outside the measuring range (far): 3.5 mA

The substitute values function can be disabled via IO-Link.

teach-in

The analog output can be scaled using the teach-in function, and the min./max. values can be assigned to the measured distances. By default, 4 mA/0 V corresponds to the minimum measuring range and 20 mA/10 V to the maximum measuring range.

 <p>4 mA 20 mA 2s 5s O1 P AO</p>	<p>Teach-in for 4 mA/0 V</p> <ol style="list-style-type: none"> 1. Adjust the sensor so that the light spot hits the object to be measured. 2. Hold down the teach-in key for 2 seconds until O begins to flash slowly. 3. Release the teach-in key. 4. The distance is programmed, and the O LED lights up to confirm successful programming.
 <p>4 mA 20 mA 2s 5s O1 P AO</p>	<p>Teach-in for 20 mA/10 V</p> <ol style="list-style-type: none"> 1. Adjust the sensor so that the light spot hits the object to be measured. 2. Press and hold the teach-in key for 5 seconds until the O LED begins to flash rapidly. 3. Release the teach-in key. 4. The distance is programmed, and the O LED lights up to confirm successful programming.



INFORMATION

Depending on whether the lower distance value is assigned to 4 mA/0 V or 20 mA/10 V, the result is either a rising or falling analog characteristic curve. If the teach-in is performed without an object or if an object is too far from the sensor, the analog value is set to the maximum value of 20 mA/10 V and LED O flashes at 8 Hz. If the teach-in is performed on an object that is too close, the analog value is set to the minimum value of 4 mA/0 V and LED O flashes at 8 Hz.

7 Function Description

The functions described in the following section can be set via wTeach or IODD via IO-Link.

7.1 Sensor Functions

Function	Possible settings	Default
Measuring mode	<p>Speed The sensor is optimized for fast applications.</p> <p>Precision The sensor is optimized for high-accuracy applications.</p> <p>Precision Plus The sensor is optimized for high-accuracy applications and even higher sensitivity to low signals.</p> <p>Note! The technical data resulting from the various modes are specified in Mode-Dependent Data [► 11].</p>	Precision
Detection mode	<p>First Object The signal reflected by an object that is within the working range and closest to the sensor is used.</p> <p>Last Object The signal reflected by an object that is within the working range and farthest from the sensor is used.</p> <p>Highest Intensity The signal with the highest signal strength is used.</p> <p>Note! If an object is hidden by this function, a blind spot directly behind the object results. The sensor cannot detect any objects within this blind spot. The size of the blind spot depends on the reflectance of the interfering object.</p>	First object
Distance range	<p>A distance range in which signals are to be evaluated can be defined within the working range. Signals outside the set distance range are ignored and are not included in the signal evaluation. This means that ranges for which no usable signals are expected can be completely hidden.</p> <p>This function can be used to suppress interfering signals, such as those produced by a glass disk, for instance. Depending on the set mode and the resulting working range, the distance range can be set within it.</p> <p>Min. distance: working range</p> <p>Max. distance: working range</p> <p>Note!</p> <ul style="list-style-type: none"> • Objects outside the set distance range are evaluated as “No signal”. • If a distance range is set, a blind spot directly behind this range results. The sensor cannot detect any objects within the blind spot. The size of the blind spot depends on the reflectance of the interfering objects in the hidden area. 	Setting range

Function	Possible settings	Default																																																
Sensitivity	<p>The sensor has very high sensitivity and can detect objects with very weak signals and measure distances to them. Constant interferences in the measured section, e.g., due to fog or dust, can result in incorrect measurements. Such interfering influences can be suppressed by reducing the sensitivity. Reducing the sensitivity also reduces the working range.</p> <p>Maximum</p> <p>In this setting, the working range corresponds to the values specified in the data sheet.</p> <p>Medium</p> <p>With this setting, the working range changes to: white (90% remission): , gray (18% remission): , black (6% remission):</p> <p>Low</p> <p>With this setting, the working range changes to: white (90% remission): , gray (18% remission): , black (6% remission):</p> <p>Minimum</p> <p>With this setting, the working range changes to: white (90% remission): , gray (18% remission): , black (6% remission):</p> <p>The technical data relating to reproducibility and linearity correspond to the typical data sheet values in the various settings.</p>	Maximum																																																
Interference filter	<p>The interference filter can be used to increase measurement reliability in the case of brief interferences in the measured section. Interferences such as rain, snow or chips in the air generate brief signals, which can result in incorrect measurements. A higher filter level allows the interfering signals to be ignored for a defined period. If the distance changes suddenly, the response time is extended. This extension of the response time depends on the filter level and the mode used. If the distance changes continuously, the response time remains unchanged when the filter is activated.</p> <table border="1"> <thead> <tr> <th></th> <th colspan="3">Mode</th> </tr> <tr> <th>Filter</th> <th>Speed</th> <th>Precision</th> <th>Precision Plus</th> </tr> </thead> <tbody> <tr> <td>Off</td> <td>-</td> <td>-</td> <td>-</td> </tr> <tr> <td>1</td> <td>2 ms</td> <td>10 ms</td> <td>20 ms</td> </tr> <tr> <td>2</td> <td>4 ms</td> <td>20 ms</td> <td>40 ms</td> </tr> <tr> <td>3</td> <td>6 ms</td> <td>30 ms</td> <td>60 ms</td> </tr> <tr> <td>4</td> <td>10 ms</td> <td>50 ms</td> <td>100 ms</td> </tr> <tr> <td>5</td> <td>20 ms</td> <td>100 ms</td> <td>200 ms</td> </tr> <tr> <td>6</td> <td>40 ms</td> <td>200 ms</td> <td>400 ms</td> </tr> <tr> <td>7</td> <td>60 ms</td> <td>300 ms</td> <td>600 ms</td> </tr> <tr> <td>8</td> <td>100 ms</td> <td>500 ms</td> <td>1,000 ms</td> </tr> <tr> <td>9</td> <td>200 ms</td> <td>1,000 ms</td> <td>2,000 ms</td> </tr> </tbody> </table>		Mode			Filter	Speed	Precision	Precision Plus	Off	-	-	-	1	2 ms	10 ms	20 ms	2	4 ms	20 ms	40 ms	3	6 ms	30 ms	60 ms	4	10 ms	50 ms	100 ms	5	20 ms	100 ms	200 ms	6	40 ms	200 ms	400 ms	7	60 ms	300 ms	600 ms	8	100 ms	500 ms	1,000 ms	9	200 ms	1,000 ms	2,000 ms	Off
	Mode																																																	
Filter	Speed	Precision	Precision Plus																																															
Off	-	-	-																																															
1	2 ms	10 ms	20 ms																																															
2	4 ms	20 ms	40 ms																																															
3	6 ms	30 ms	60 ms																																															
4	10 ms	50 ms	100 ms																																															
5	20 ms	100 ms	200 ms																																															
6	40 ms	200 ms	400 ms																																															
7	60 ms	300 ms	600 ms																																															
8	100 ms	500 ms	1,000 ms																																															
9	200 ms	1,000 ms	2,000 ms																																															
Emitted light	<p>The sensor's laser can be switched on or off.</p> <p>On</p> <p>Laser on</p> <p>Off</p> <p>Laser off</p>	On																																																

	<p>The sensor no longer supplies a measured value.</p> <p>Note!</p> <ul style="list-style-type: none"> • If an input is set as a laser-off input, the emitted light can also be switched on and off via the input. • If the laser is switched off, the sensor behavior corresponds to the status “No signal.” 	
Localization	<p>The sensor's supply voltage indicator can be set to flash blue. This makes it easy to locate the sensor in a system.</p> <p>On</p> <p>The LED supply voltage indicator flashes blue.</p> <p>Off</p> <p>LEDs in normal operation.</p>	Off
Measured value unit	<p>The measured distance can be read out in millimeters or inches.</p> <p>Millimeter</p> <p>Distance values read out in mm</p> <p>Inch</p> <p>Distance values read out in 1/10 inch</p>	Millimeter

7.2 Pin Function

The pin function is used to define the function of pins I/O1 and I3, as these can be used for different functions.

pin	Possible settings	Default
I/O1	<p>switching output</p> <p>The switching output is assigned to switching point SSC1.</p> <p>error output</p> <p>The error output switches when one of the assigned errors occurs; see the Status Messages table.</p> <p>Warning output</p> <p>The warning output switches when one of the assigned warnings occurs; see the Status Messages table.</p> <p>Laser-off input</p> <p>For explanation, see I3</p> <p>teach-in input</p> <p>For explanation, see I3</p> <p>Speed measurement Reset input</p> <p>See I3 for explanation</p> <p>Disabled</p> <p>The pin is disabled.</p>	switching output
I3	<p>Laser off input</p> <p>The sensor's transmission light is deactivated as long as the input is activated. The sensor then does not provide a measured value and sets the status to "No signal."</p> <p>teach-in input</p> <p>teach-in</p> <p>The outputs can be set using the same procedure as with the teach-in key (see section Configuration with Push of Button / Teach-In [▶ 17]). An activated input corresponds to a pressed teach-in key.</p>	Laser off input

pin	Possible settings	Default
	<p>Locking</p> <p>If the teach-in input is permanently set to 18...30 V DC, the teach-in key is locked and protected against unintentional adjustment as long as the input signal is present.</p> <p>Speed measurement Reset input</p> <p>The "Speed" status message is reset.</p> <p>Deactivated</p> <p>The pin is deactivated.</p>	

7.2.1 Output Functions

The output functions are used to set the physical outputs.

Digital Outputs

Function	Possible settings	Default
Polarity	<p>PNP</p> <p>NPN</p> <p>Push-pull</p>	PNP
Circuit	<p>NO</p> <p>Light switching (Normally Open)</p> <p>The output is high when the condition has been satisfied, depending on settings (switching point, warning, error).</p> <p>NC</p> <p>Dark switching (normally closed)</p> <p>The output is low when the condition has been fulfilled depending on the setting (switching point, warning, error).</p>	NO
On-delay	0...10,000 ms	0 ms
Off-delay	0...10,000 ms	0 ms

Analog outputs

7.2.2 Input Functions

The input functions are used to set the physical inputs.

Function	Possible settings	Default
Input mode	<p>Supply voltage active</p> <p>Function is triggered as soon as supply voltage is applied to the input.</p> <p>Supply voltage inactive</p> <p>Function is triggered as soon as 0 V is applied to the input or the input is opened.</p>	Supply voltage active

7.2.3 Switching Point Functions (SSC1/SSC2)

The two switching points, SSC1 and SSC2, are set using the switching point functions.

Function	Possible settings	Default
Teach-in	Starts the teach-in process.	
teach-in-	foreground teach-in	foreground teach-in

Function	Possible settings	Default
mode	<p>The diagram illustrates three teach-in modes for a sensor:</p> <ul style="list-style-type: none"> Standard teach-in: An object is positioned below a horizontal line. A vertical arrow labeled 'Teach-in distance' extends from the top of the object to a point labeled 'Sensor'. A dotted line labeled 'Switching point' is located on the horizontal line to the right of the object. background teach-in: Similar to the standard mode, but the 'Teach-in distance' arrow is longer, indicating a greater distance between the object and the sensor. window teach-in: An object is positioned below a horizontal line. A vertical arrow labeled 'Teach-in distance' extends from the top of the object to a point labeled 'Sensor'. A dotted line labeled 'Switching point' is on the horizontal line. A 'Window size' is indicated by a vertical double-headed arrow between two additional dotted lines labeled 'Near switching point' and 'Far switching point'. 	
switching point	50...10,000 mm Note! If a distance range has been set, the switching point can only be set within the specified distance range.	5,000 mm
Hysteresis	Hysteresis is the difference between the switch-on and switch-off point. 5...1,000 mm	15 mm
Close Switching Point Window	In teach-in mode window teach-in Distance from the set window center to the sensor-side switching point of the window. The window can be set so that it extends from the minimum setting range to the maximum setting range of the sensor. The minimum and maximum possible settings are determined by the respective set window center.	30 mm
Window Switching Point Far	In window teach-in mode Distance from the set window center to the window's switching point far from the sensor. The window can be set to extend from the minimum setting range to the maximum setting range of the sensor. The minimum and maximum possible settings are determined by the respective set window center.	30 mm

7.2.4 Condition Monitoring Functions

7.2.4.1 Status Message Function

The sensor provides various status messages. Due to the process data structure, four status messages can be transmitted as individual process data.

These parameters can be used to set the status messages that are transmitted via the process data.

Function	Available settings	Default
Message 1	See table	Warning signal
Message 2	See table	Optics contaminated
Message 3	See table	ambient light
Message 4	See table	Accelerometer

7.2.4.2 Warning/Error Output Function

The status messages used to trigger the collective message can be defined for the warning output and the error output respectively. The status messages are OR-linked so that the output is activated when one of the defined status messages is activated.

Function	Possible settings	Default
Warning output	See table "Status Messages"	Signal warning, optics dirty, ambient light, temperature too high, temperature too low, undervoltage, interference in the working range
Error output	See table "Status Messages"	Object too close, object too far, no signal, device error, over-temperature, short circuit

Status messages

Warning	
Undervoltage	The supply voltage is too low.
Warning signal	The object reflects too little light.
Contaminated optics	The sensor detects when the optic cover is dirty, and the signal deteriorates as a result
Ambient light	Object detection is impeded by ambient light.
Interference in the working range	When using the interference filter, the sensor detects whether a brief interfering event has occurred in the measuring range. This could be chips, water droplets, etc., for instance.
Temperature too high	The sensor's internal temperature is high.
Temperature too low	The sensor's internal temperature is low.
Device warning	An internal device error has occurred.
Emitted light off	The sensor's emitted light is switched off.

Error	
Short circuit	A short circuit has occurred on at least one pin.
No signal	The sensor is not receiving a signal.
Object too close	The object is below the setting range or the set measuring range.
Object too far	The object is above the setting range or the set measuring range.
Over-temperature	The over-temperature has been exceeded. To protect the emitting unit, the laser is switched off.

Error	
Device error	A hardware error has occurred. For safety reasons, the emitted light is switched off.

Accelerometer	
Acceleration detected	The sensor has detected acceleration above the set threshold via the internal accelerometer.

7.2.4.3 Accelerometer

The sensor features a built-in accelerometer. This detects acceleration and can therefore identify impacts or shock loads.

Function	Possible settings	Default setting
Accelerometer	On Accelerometer enabled Off Acceleration sensor deactivated The status message remains active until it is acknowledged. This ensures that even messages occurring in intervals shorter than the cycle time are reliably detected	On
Acceleration Threshold	The threshold defines how sensitive the acceleration sensor is 0...100 %	50
Counter	The Counter counts the number of times the set threshold has been exceeded.	0

7.2.4.4 Signal Monitoring

The sensor can detect up to four objects within its working range. It determines the distance and signal strength for each of these objects.

Function	Possible settings	Default setting
Signal monitoring	On Signal monitoring enabled Off Signal monitoring disabled	Off
Object detection status	Indicates which object is used for signal evaluation. Object 1-4	—
Object Distance	Displays the respective distance of up to four objects. 50...10,000 mm	—
Object Signal	Displays the respective signal strength of up to four objects. 1...1,000	—

7.2.5 Simulation Functions

This function simulates the behavior of the sensor regardless of its current status and measured value. This allows you to check whether a system in which the sensor is integrated responds correctly to the data supplied by the sensor and processes it accordingly.

If a measured value is specified, the sensor behaves as if the specified measured value corresponds to the actual measured value. This means that the behavior of the outputs and status messages is simulated according to the specified measured value.

In addition, the individual outputs and status messages can be simulated separately from the measured value.

Function	Possible settings	Default
Simulation mode	On Off	Off
Test measured value	Current measured value min...max. measuring range	Current measured value
Test output AO	According to measured value	According to measured value
SSC1 Test	According to the measured value On Off	According to measured value
SSC2 Test	According to the measured value On Off	According to measured value
Status messages test	Tests the individual status messages according to the measured value On Off	According to measured value



INFORMATION

The O1 output is used for IO-Link communication in this function and cannot be simulated. Simulation mode is automatically terminated as soon as the voltage supply is interrupted.

7.3 Condition Monitoring/Process Data

The data described in the following section can be read or written cyclically via IO-Link/process data.

7.3.1 Process Data In

Data	Meaning
Measured value	Measured distance in mm or 1/10 inch As the sensor cannot determine a measured value in the following error cases, substitute values are read out: No signal: 0x7FFC / 32764 mm Object too close: 0x8008 / -32760 mm Object too far: 0x7FF8 / 32760 mm
Scale	Scaling of the measured value to the base length unit; -3 corresponds to mm.
SSC1	Switching point 1
SSC2	Switching point 2
Warning	Collective warning in the event of one of the warning status messages (see table "Status messages") in the error output function)
Error	Collective warning in the event of one of the error status messages (see table "Status messages") in error output function.
Message 1	Status message 1 read out see Status Message Function [▶ 24]
Message 2	Status message 2 read out see Status Message Function [▶ 24]
Message 3	Status message 3 read out see Status Message Function [▶ 24]
Message 4	Status message 4 read out see Status Message Function [▶ 24]

7.3.2 Process Data Out

Data	Meaning
Emitted light	Transmit signal on/off
Localization	Sensor flashes for easy sensor location
Teach-in SSC1	Starts the teach-in process for SSC1
Teach-in SSC2	Starts the teach-in process for SSC2
Reset Accelerometer	Status message "Accelerometer" is reset

7.3.3 Events

Events are diagnostic information that is standardized by IO-Link and exchanged between the IO-Link master and the device. The following events are supported:

Name	Event code	Type	Specification
Maintenance required - Cleaning	0x8C40	Notification	IO-Link
Device error – Unknown error	0x1000	Error	IO-Link
Short circuit – Check installation	0x7710	Error	IO-Link
Device temperature too high – Remove heat source	0x4210	Warning	IO-Link
Device temperature too low - Isolate the device	0x4220	Warning	IO-Link
Temperature error - Overload	0x4000	Error	IO-Link
Supply voltage too low – check tolerances	0x5111	Warning	IO-Link
Acceleration sensor	0x1801	Warning	wenglor specific

8 **wTeach2 Configuration Software**

For information on installing and connecting the wTeach2 software and its structure, as well as information on the general functions, see the wTeach2 operating instructions. They can be found online in the download area at www.wenglor.com under order number DNNF005.

9 Maintenance Instructions



NOTICE

This wenglor product is maintenance-free.

Cleaning and inspection of the plug connections at regular intervals are advisable.

Do not clean the product with solvents or cleaning agents that could damage the product.

The product must be protected against contamination during initial start-up.

10 Proper Disposal

wenglor sensoric GmbH does not accept the return of unusable or irreparable products. Respectively valid national waste disposal regulations apply to product disposal.

11 Declarations of Conformity

Declarations of conformity can be found on our website at www.wenglor.com in the product's separate download area.