

Operating Instructions

INTT311

Inductive Sensor for Extreme Temperature Ranges

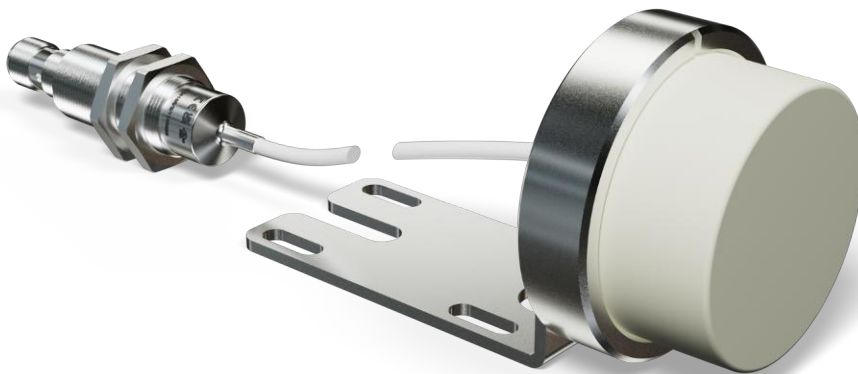

EN



Table of Contents

1	General	3
1.1	Information Concerning these Instructions	3
1.2	Explanation of Symbols	3
1.3	Limitation of Liability	4
1.4	Copyrights	4
2	For Your Safety	5
2.1	Use for Intended Purpose	5
2.2	Use for Other than the Intended Purpose	5
2.3	Personnel Qualifications	5
2.4	Modification of Products	6
2.5	General Safety Precautions	6
2.6	Approvals and protection classes	6
3	Technical Data	7
3.1	General Information	7
3.2	Housing Dimensions	8
3.3	Control panel	9
3.4	Complementary Products	9
4	Transport and Storage	10
4.1	Transport	10
4.2	Storage	10
5	Installation and Electrical Connection	11
5.1	Installation	11
5.1.1	Installation using a quick-release fastener	11
5.1.2	Other Installation Options	12
5.2	Installation Instructions	12
5.2.1	Installation Instructions for Sensors with weproTec	12
5.3	Electrical Connection	14
5.4	Troubleshooting	15
6	Settings via IO-Link	16
7	Maintenance Instructions	17
8	Proper Disposal	18
9	Declarations of Conformity	19

1 General

1.1 Information Concerning these Instructions

- It ensures safe and efficient use of the product.
- This manual is part of the product and must be retained for the entire service life.
- In addition, local accident prevention regulations and national occupational safety regulations must be observed.
- The product is subject to technical development, so the instructions and information in these operating instructions are also subject to change. You can find the current version at www.wenglor.com in the product's download section.



INFORMATION

The operating instructions must be read carefully before use and kept for future reference.

1.2 Explanation of Symbols

- Safety precautions and warnings are emphasized by means of symbols and signal words.
- Safe use of the product is only possible if these safety precautions and warnings are adhered to.

The safety precautions and warnings are laid out in accordance with the following principle:

SIGNAL WORD

Type and source of danger!

Possible consequences in the event that the hazard is disregarded.

→ Measures for averting the hazard.

The meanings of the signal words, as well as the scope of the associated hazards, are listed below:



! DANGER

This signal word indicates a hazard with a high degree of risk which, if not avoided, results in death or severe injury.



! WARNING

This signal word indicates a hazard with a medium degree of risk which, if not avoided, may result in death or severe injury.



! CAUTION

This signal word indicates a hazard with a low degree of risk which, if not avoided, may result in minor or moderate injury.



NOTICE

This signal word draws attention to a potentially hazardous situation which, if not avoided, may result in property damage.



INFORMATION

Information draws attention to useful tips and suggestions, as well as information on efficient, error-free use.

1.3 Limitation of Liability

- The product has been developed in consideration of the current state-of-the-art technology, as well as applicable standards and guidelines. Subject to change without notice.
- A valid declaration of conformity can be accessed at www.wenglor.com in the product's separate download area.
- wenglor sensoric elektronische Geräte GmbH (hereinafter referred to as "wenglor") excludes all liability in the event of:
 - Non-compliance with the instructions
 - Use of the product for purposes other than those intended.
 - Use by untrained personnel.
 - Use of unapproved spare parts.
 - Unapproved modification of products.
- These operating instructions do not include any guarantees from wenglor with regard to the described procedures or specific product characteristics.
- wenglor assumes no liability for printing errors or other inaccuracies contained in these operating instructions unless wenglor was verifiably aware of such errors at the point in time at which the operating instructions were prepared.

1.4 Copyrights

- The contents of these instructions are protected by copyright law.
- All rights are reserved by wenglor.
- Commercial reproduction or any other commercial use of the provided content and information, in particular graphics and images, is not permitted without previous written consent from wenglor.

2 For Your Safety

2.1 Use for Intended Purpose

Inductive sensors

An LC resonant circuit is located beneath the active surface of inductive sensors. The electromagnetic field generated by this circuit is affected when metals (e.g., steel, aluminum, or brass) approach. When the metal reaches the set switching distance, the output switches.

This Product Can Be Used in the Following Industry Sectors:

- Special-purpose mechanical engineering
- Heavy mechanical engineering
- Logistics
- Automotive industry
- Food industry
- Packaging industry
- Pharmaceuticals industry
- Plastics industry
- Woodworking industry
- Consumer goods industry
- Paper industry
- Electronics industry
- Glass industry
- Steel industry
- Aviation industry
- Chemicals industry
- Alternative energies
- Raw materials extraction

2.2 Use for Other than the Intended Purpose

- Not a safety component in accordance with 2006/42/EC (Machinery Directive).
- The product is not suitable for use in potentially explosive atmospheres.
- The product may be used only with accessories supplied or approved by wenglor, or in combination with approved products. A list of approved accessories and combination products can be found at www.wenglor.com on the product detail page.



DANGER

Risk of personal injury or property damage in case of use for other than the intended purpose!

Use for other than the intended purpose may lead to hazardous situations.

- Observe instructions regarding use for intended purpose.

2.3 Personnel Qualifications

- Suitable technical training is a prerequisite.
- In-house electronics training is required.
- Trained personnel who use the product must have (permanent) access to the operating instructions.



DANGER

Risk of personal injury or property damage in case of incorrect initial start-up and maintenance!

Personal injury and damage to equipment may occur.

→ Adequate training and qualification of personnel

2.4 Modification of Products



DANGER

Risk of personal injury or property damage if the product is modified!

Personal injury and damage to equipment may occur. Noncompliance may result in loss of the CE and/or UKCA mark and voiding of the warranty.

→ Modification of the product is not permitted

2.5 General Safety Precautions



INFORMATION

These instructions are an integral part of the product and must be kept on hand for the entire duration of its service life.

In the event of possible changes, the current version of the operating instructions can be found at www.wenglor.com in the product's separate download area.

Read the operating instructions carefully before using the product.

Protect the sensor against contamination and mechanical influences.

2.6 Approvals and protection classes

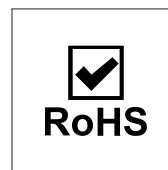
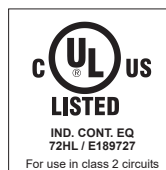
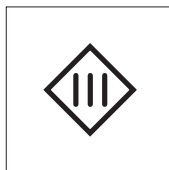

3 Technical Data

3.1 General Information

	INTT311
Inductive data	
Switching Distance	40 mm
Standard Target	120 × 120 mm
Correction Factors Stainless Steel V2A/CuZn/Al	1,10/0,65/0,58
Mounting	Non-flush
Mounting A/B/C/D in mm	30/130/80/20
Mounting B1 in mm	0...70
Switching Hysteresis	< 10 %
Electrical data	
Supply Voltage	10...30 V DC
Supply Voltage with IO-Link	18...30 V DC
Current Consumption (U _b = 24 V)	< 15 mA
Switching Frequency	50 Hz
Temperature Drift	< 10 %
Sensor head temperature range	-10...250 °C
Analysis module temperature range	0...70 °C
Number of Switching Outputs	2
Switching Output Voltage Drop	< 1.5 V
Switching Output/Switching Current	100 mA
Residual Current Switching Output	< 100 µA
Short Circuit Protection	yes
Reverse Polarity Protection	yes
Overload Protection	yes
Interface	IO-Link V1.1
Protection Class	III
Service Life (T = +200 °C)	100000 h
Service Life (T = +250 °C)	60000 h
Mechanical data	
Sensing face	Plastic, PEEK
Sensor head material	Stainless steel, V2A (1.4305 / 303)
Analysis module material	Stainless steel, V2A (1.4305 / 303)
Degree of Protection	IP65
Connection	M12 × 1; 4-pin
Cable length (L)	20 m
Cable Jacket Material	Plastic, PFA
Outer diameter cable	3.4 mm
Bending Radius	> 17 mm
PWIS-free	yes
Safety technology data	
MTTFd (EN ISO 13849-1)	3706.54 a
Function	
Error Indicator	yes
Programmable switching distance	30/35/40 mm
output function	

3.3 Control panel

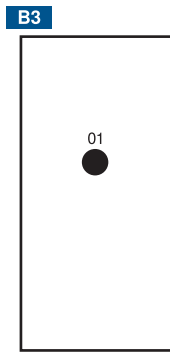

01 = Switching Status Indicator

3.4 Complementary Products

wenglor offers you the right connection and mounting technology as well as other accessories for your product. You can find this at www.wenglor.com on the product details page at the bottom.

4 Transport and Storage

4.1 Transport

Upon receipt of shipment, the goods must be inspected for damage in transit. In the case of damage, conditionally accept the package and notify the manufacturer of the damage. Then return the device, making reference to damage in transit.

4.2 Storage

The following points must be taken into consideration with regard to storage:

- Do not store the product outdoors.
- Store the product in a dry, dust-free place.
- Protect the product against mechanical impacts.
- Protect the product against exposure to direct sunlight.



NOTICE

Risk of property damage in case of improper storage!

The product may be damaged.

→ Storage instructions must be complied with.

5 Installation and Electrical Connection

5.1 Installation

- Protect the product from contamination during installation.
- Observe all applicable electrical and mechanical regulations, standards, and safety rules.
- Protect the product against mechanical influences.
- Make sure that the sensor is mounted in a mechanically secure fashion.
- Specified torque values must be complied with (see section Technical Data [▶ 7]).
- Both the sensor cable and the connection line must be routed separately from power cables (e.g., frequency converters).
- The sensor cable is not suitable for use in drag chains and must not be crushed.
- When routing the cable, ensure that the bending radius is not less than five times the cable diameter (see section Technical Data [▶ 7]).



NOTICE

Care must be taken to ensure that the plug does not heat up to over 70 °C.

- Installation instructions must be observed (see Technical Data [▶ 7] section).



NOTICE

Risk of property damage in case of improper installation!

The product may be damaged!

- Comply with installation instructions.



CAUTION

Risk of personal injury or property damage during installation!

Personal injury and damage to the product may occur.

- Ensure a safe installation environment.

5.1.1 Installation using a quick-release fastener

Initial installation

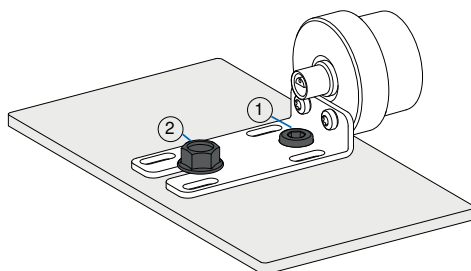

- Screw the M8 hex head cap screw (1) into the designated mounting position and place the pre-assembled mounting bracket of the sensor head onto the installed M8 hex head cap screw (thread it on). Now position the sensor head in the desired orientation.
- Secure the position by tightening the M8 hex head cap screw (2).

Sensor Replacement



INFORMATION

It is not necessary to loosen the M8 cylinder head bolt (1) when removing or replacing the sensor head.

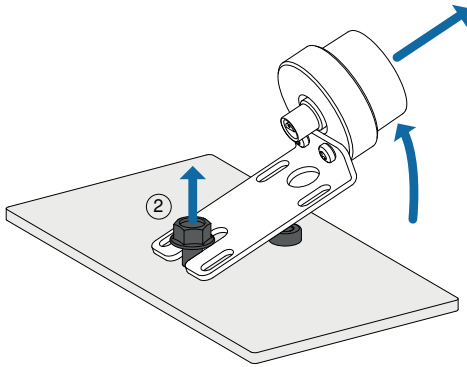

- To replace the sensor head, slightly loosen the M8 hex head screw (2). It is not necessary to unscrew it completely.
- Lift the mounting bracket together with the sensor head and pull it off. Now insert the new sensor head and secure it as described above.

5.1.2 Other Installation Options

Precise positioning is possible thanks to the screws in the four slotted holes. Loosen these slightly. You can now slide the sensor back and forth until it is perfectly aligned. Then tighten the screws again.

5.2 Installation Instructions

5.2.1 Installation Instructions for Sensors with weproTec

weproTec is the abbreviation for wenglor proximity switch technology, an innovative, patented wenglor technology for inductive sensors.

Inductive sensors with weproTec can be mounted very close to each other (→ installation dimension B1) or opposite each other ($1.5 \times S_n$). There is no mutual interference between the sensors in the defined areas.

The installation instructions according to the standard (see section Installation instructions according to standard) also apply.

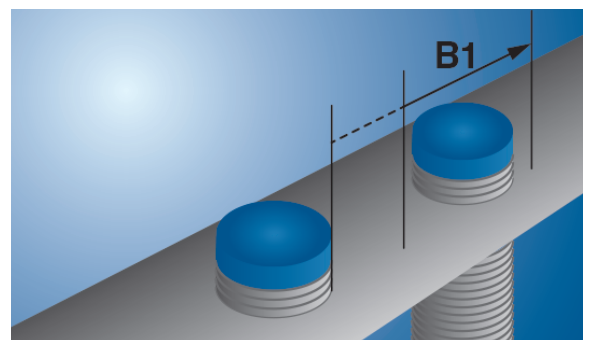
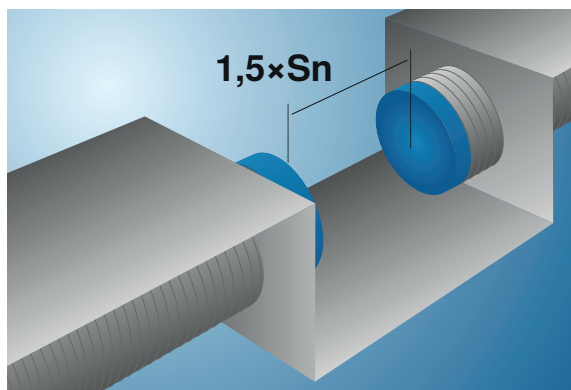

Installation dimension	Description
A	Minimum distance from the sensor to the damping material (e.g., steel).
B	Minimum distance between two inductive sensors. The distance applies to installation in air. If the sensors are installed in an attenuating material (e.g., steel), the distance is reduced. The exact distance must be tested in the application.

B	<p>Additional minimum distance between two inductive sensors.</p> <p>The distance applies to installation in air. If the sensors are installed in an attenuating material (e.g., steel), the distance is reduced. The exact distance must be tested in the application.</p>
C	<p>Minimum distance between the active surface of the inductive sensor and the damping material (e.g., steel).</p> <p>The distance C does not refer to the object to be detected, but to the background. The object to be detected is detected within the switching distance.</p>
D	<p>Minimum dimension by which the sensor (active surface) must protrude from the damping material (e.g., steel).</p>
$1.5 \times S_n$	<p>Opposite installation. Two identical sensors must be mounted at this minimum distance.</p>

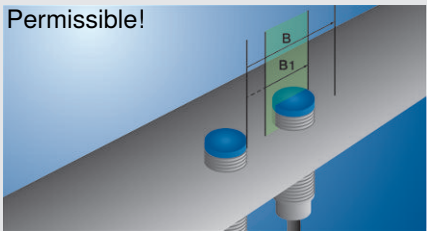
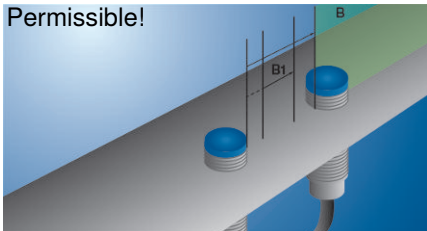
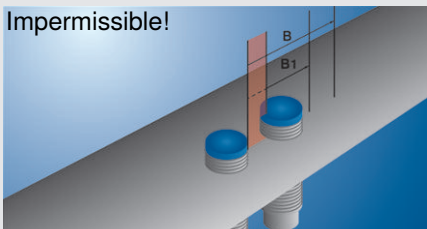
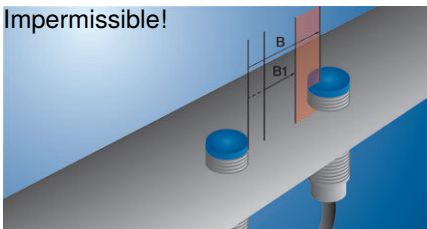
Installation variant	Description
<p>Permissible!</p> 	<p>Two sensors can be mounted next to each other in area B1.</p>
<p>Permissible!</p> 	<p>Two sensors can be mounted next to each other from installation dimension B.</p>
<p>Impermissible!</p> 	<p>Two sensors must not be mounted next to each other in front of area B1.</p>
<p>Impermissible!</p> 	<p>Two sensors must not be mounted in the area between B1 and B.</p>

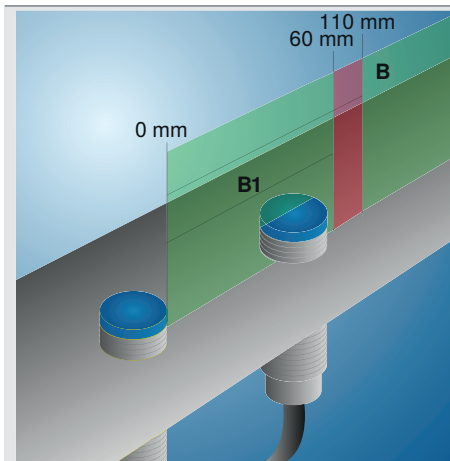

Example: B1 starts at 0 mm

Installation B1 in mm: 0...60

- Installation A/B/C/D in mm: x/110/x/x
- Not allowed area: 60...110 mm

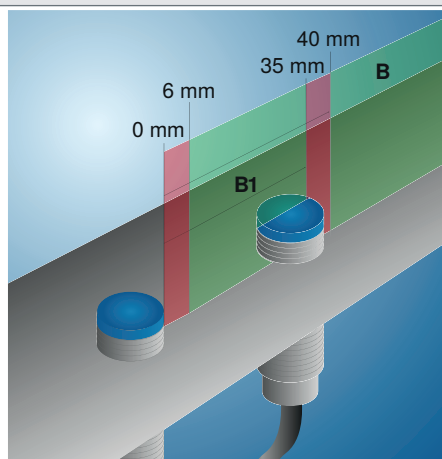

Example: B1 does not start at 0 mm

- Installation B1 in mm: 6...35
- Installation A/B/C/D in mm: x/40/x/x

5.3 Electrical Connection

- Wire the sensor in accordance with the connection diagram.
- Switch on the supply voltage (see section Technical Data [► 7])
- If using IO-Link, connect the sensor to 18...30 V DC.
- If not using IO-Link, connect the sensor to 10...30 V DC.



⚠ DANGER

Risk of personal injury or property damage due to electric current.

Voltage-conducting parts may cause personal injury or damage to equipment.

→ The electric device may be connected by appropriately qualified personnel only.

704

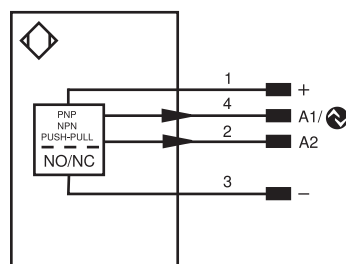

Legend					
+	Supply Voltage +	PT	Platinum measuring resistor	ENARs422	Encoder A/Ā (TTL)
–	Supply Voltage 0 V	nc	Not connected	ENBRs422	Encoder B/B̄ (TTL)
~	Supply Voltage (AC Voltage)	U	Test Input	ENA	Encoder A
A	Switching Output (NO)	Ū	Test Input inverted	ENb	Encoder B
Ā	Switching Output (NC)	W	Trigger Input	AMIN	Digital output MIN
V	Contamination/Error Output (NO)	W–	Ground for the Trigger Input	AMAX	Digital output MAX
Ṽ	Contamination/Error Output (NC)	O	Analog Output	AOK	Digital output OK
E	Input (analog or digital)	O–	Ground for the Analog Output	SY In	Synchronization In
T	Teach Input	BZ	Block Discharge	SY OUT	Synchronization OUT
R	Reset input	AMv	Valve Output	OLT	Brightness output
Z	Time Delay (activation)	a	Valve Control Output +	M	Maintenance
S	Shielding	b	Valve Control Output 0 V	rsv	Reserved
RxD	Interface Receive Path	SY	Synchronization	Wire Colors according to DIN IEC 60757	
TxD	Interface Send Path	SY–	Ground for the Synchronization	BK	Black
RDY	Ready	E+	Receiver-Line	BN	Brown
GND	Ground	S+	Emitter-Line	RD	Red
CL	Clock	⊕	Grounding	OG	Orange
E/A	Output/Input programmable	SnR	Switching Distance Reduction	YE	Yellow
	IO-Link	Rx+/-	Ethernet Receive Path	GN	Green
PoE	Power over Ethernet	Tx+/-	Ethernet Send Path	BU	Blue
IN	Safety Input	Bus	Interfaces-Bus A(+)/B(-)	VT	Violet
OSSD	Safety Output	La	Emitted Light disengageable	GY	Grey
Signal	Signal Output	Mag	Magnet activation	WH	White
BI_D+/-	Ethernet Gigabit bidirect. data line (A-D)	RES	Input confirmation	PK	Pink
EN0 RS422	Encoder 0-pulse 0/0̄ (TTL)	EDM	Contacting Monitoring	GNYE	Green/Yellow

5.4 Troubleshooting

The sensors integrate an error indicator (flashes continuously at 5 Hz). Possible causes for the error message (LED) are:

Error	Possible cause	Remedy
Error	Short circuit on output 1	Check the wiring and eliminate the short circuit
	Mechanical damage to the coil	Replace sensor



INFORMATION

Action in case of error:

1. Take the machine out of service.
2. Analyze and rectify the cause of the error using the diagnostic information.
3. If the fault cannot be rectified, contact wenglor support.
4. Do not operate the machine if the error behavior is unclear.
5. The machine must be taken out of service if the error cannot be clearly identified or reliably rectified.



DANGER

Risk of personal injury or property damage if not observed!

The safety function of the system is disabled. Damage to personnel and equipment.

- Behavior in case of error as specified.

6 Settings via IO-Link

The sensors can exchange parameters and process data via IO-Link. The parameters can be used to make many additional settings on the device. The process data transmit cyclical data and condition monitoring.

To this end, the sensor is connected to a suitable IO-Link master (see product detail page/complementary products). The interface protocol and the IO-Link data sheet can be found at www.wenglor.com in the download area for the respective product.

Process data:

- Object detected
- error indicator

Parameter data:

- Switching distance (3 selectable)
- Output function A1 (PNP, NPN, push-pull)
- Switching function A1 (NO, NC)
- Switching function A2 (antivalent, error output NO, error output NC, no output)

7 Maintenance Instructions



NOTICE

This wenglor product is maintenance-free.

Cleaning and inspection of the plug connections at regular intervals are advisable.

Do not clean the product with solvents or cleaning agents that could damage the product.

The product must be protected against contamination during initial start-up.

8 Proper Disposal

wenglor sensoric GmbH does not accept the return of unusable or irreparable products. Respectively valid national waste disposal regulations apply to product disposal.

9 **Declarations of Conformity**

Declarations of conformity can be found on our website at www.wenglor.com in the product's separate download area.