

Operating Instructions

**INTT323**

# Inductive Analysis Module for Extreme Temperature Ranges



EN



# Table of Contents

<b>1</b>	<b>General</b> .....	<b>3</b>
1.1	Information Concerning these Instructions.....	3
1.2	System overview .....	3
1.3	Explanation of Symbols.....	3
1.4	Limitation of Liability .....	4
1.5	Copyrights.....	5
<b>2</b>	<b>For Your Safety</b> .....	<b>6</b>
2.1	Use for Intended Purpose.....	6
2.2	Use for Other than the Intended Purpose.....	6
2.3	Personnel Qualifications.....	6
2.4	Modification of Products.....	7
2.5	General Safety Precautions .....	7
2.6	Approvals and protection classes.....	7
<b>3</b>	<b>Technical Data</b> .....	<b>8</b>
3.1	General Information.....	8
3.2	Housing Dimensions .....	10
3.3	Control panel .....	11
3.4	Complementary Products .....	11
<b>4</b>	<b>Transport and Storage</b> .....	<b>12</b>
4.1	Transport .....	12
4.2	Storage .....	12
<b>5</b>	<b>Installation and Electrical Connection</b> .....	<b>13</b>
5.1	Installation .....	13
5.1.1	Installation using a quick-release fastener.....	14
5.1.2	Other Installation Options.....	14
5.2	Installation for IP51.....	14
5.3	Installation Instructions .....	15
5.3.1	Installation Instructions for Sensors with weproTec .....	15
5.4	Electrical Connection .....	17
5.5	Troubleshooting .....	18
<b>6</b>	<b>Settings via IO-Link</b> .....	<b>19</b>
<b>7</b>	<b>Maintenance Instructions</b> .....	<b>20</b>
<b>8</b>	<b>Proper Disposal</b> .....	<b>21</b>
<b>9</b>	<b>Declarations of Conformity</b> .....	<b>22</b>

# 1 General

## 1.1 Information Concerning these Instructions

- These instructions apply to inductive sensors with replaceable sensor heads, consisting of a sensor head (item no. INTT320) and an inductive analysis module with cable (item no. INTT323, INTT327, INTT329, INTT331, INTT347, INTT349, and INTT351). The permitted combinations of sensor heads and inductive evaluation units are shown in the system overview [► 3].



### NOTICE

Some of the functions described in the manual are only possible in combination with a suitable analysis module or sensor head (see system overview [► 3]).

- It ensures safe and efficient use of the product.
- This manual is part of the product and must be retained for the entire service life.
- In addition, local accident prevention regulations and national occupational safety regulations must be observed.
- The product is subject to technical development, so the instructions and information in these operating instructions are also subject to change. You can find the current version at [www.wenglor.com](http://www.wenglor.com) in the product's download section.



### INFORMATION

The operating instructions must be read carefully before use and kept for future reference.

## 1.2 System overview

analysis module	switching distance	cable length	Intended use	Compatible sensor head
INTT323	40 mm	5 m	Static applications	INTT320
INTT327	40 mm	10 m	Static applications	INTT320
INTT329	40 mm	15 m	Static applications	INTT320
INTT331	40 mm	20 m	Static applications	INTT320
INTT347	40 mm	10 m	Dynamic applications	INTT320
INTT349	40 mm	15 m	Dynamic applications	INTT320
INTT351	40 mm	20 m	Dynamic applications	INTT320



### INFORMATION

"Dynamic applications" refer to applications that place increased demands on the bending cycles of cables, such as in lifts or hoisting units. In such cases, care must be taken to ensure that the cables are routed freely in cable loops. Dynamic applications are not to be confused with drag chain applications.

## 1.3 Explanation of Symbols

- Safety precautions and warnings are emphasized by means of symbols and signal words.
- Safe use of the product is only possible if these safety precautions and warnings are adhered to.

The safety precautions and warnings are laid out in accordance with the following principle:

### SIGNAL WORD

### Type and source of danger!

Possible consequences in the event that the hazard is disregarded.

→ Measures for averting the hazard.

The meanings of the signal words, as well as the scope of the associated hazards, are listed below:



#### **DANGER**

This signal word indicates a hazard with a high degree of risk which, if not avoided, results in death or severe injury.



#### **WARNING**

This signal word indicates a hazard with a medium degree of risk which, if not avoided, may result in death or severe injury.



#### **CAUTION**

This signal word indicates a hazard with a low degree of risk which, if not avoided, may result in minor or moderate injury.



#### **NOTICE**

This signal word draws attention to a potentially hazardous situation which, if not avoided, may result in property damage.



#### **INFORMATION**

Information draws attention to useful tips and suggestions, as well as information on efficient, error-free use.

## 1.4 Limitation of Liability

- The product has been developed in consideration of the current state-of-the-art technology, as well as applicable standards and guidelines. Subject to change without notice.
- A valid declaration of conformity can be accessed at [www.wenglor.com](http://www.wenglor.com) in the product's separate download area.
- wenglor sensoric elektronische Geräte GmbH (hereinafter referred to as "wenglor") excludes all liability in the event of:
  - Non-compliance with the instructions
  - Use of the product for purposes other than those intended.
  - Use by untrained personnel.
  - Use of unapproved spare parts.
  - Unapproved modification of products.
- These operating instructions do not include any guarantees from wenglor with regard to the described procedures or specific product characteristics.
- wenglor assumes no liability for printing errors or other inaccuracies contained in these operating instructions unless wenglor was verifiably aware of such errors at the point in time at which the operating instructions were prepared.

## 1.5 Copyrights

- The contents of these instructions are protected by copyright law.
- All rights are reserved by wenglor.
- Commercial reproduction or any other commercial use of the provided content and information, in particular graphics and images, is not permitted without previous written consent from wenglor.

## 2 For Your Safety

### 2.1 Use for Intended Purpose

#### Inductive sensors

An LC resonant circuit is located beneath the active surface of inductive sensors. The electromagnetic field generated by this circuit is affected when metals (e.g., steel, aluminum, or brass) approach. When the metal reaches the set switching distance, the output switches.

#### This Product Can Be Used in the Following Industry Sectors:

- Special-purpose mechanical engineering
- Heavy mechanical engineering
- Logistics
- Automotive industry
- Food industry
- Packaging industry
- Pharmaceuticals industry
- Plastics industry
- Woodworking industry
- Consumer goods industry
- Paper industry
- Electronics industry
- Glass industry
- Steel industry
- Aviation industry
- Chemicals industry
- Alternative energies
- Raw materials extraction

### 2.2 Use for Other than the Intended Purpose

- Not a safety component in accordance with 2006/42/EC (Machinery Directive).
- The product is not suitable for use in potentially explosive atmospheres.
- The product may be used only with accessories supplied or approved by wenglor, or in combination with approved products. A list of approved accessories and combination products can be found at [www.wenglor.com](http://www.wenglor.com) on the product detail page.



#### **DANGER**

#### **Risk of personal injury or property damage in case of use for other than the intended purpose!**

Use for other than the intended purpose may lead to hazardous situations.

→ Observe instructions regarding use for intended purpose.

### 2.3 Personnel Qualifications

- Suitable technical training is a prerequisite.
- In-house electronics training is required.
- Trained personnel who use the product must have (permanent) access to the operating instructions.



## **DANGER**

### **Risk of personal injury or property damage in case of incorrect initial start-up and maintenance!**

Personal injury and damage to equipment may occur.

→ Adequate training and qualification of personnel

---

## 2.4 Modification of Products



## **DANGER**

### **Risk of personal injury or property damage if the product is modified!**

Personal injury and damage to equipment may occur. Noncompliance may result in loss of the CE and/or UKCA mark and voiding of the warranty.

→ Modification of the product is not permitted

---

## 2.5 General Safety Precautions



## **INFORMATION**

These instructions are an integral part of the product and must be kept on hand for the entire duration of its service life.

In the event of possible changes, the current version of the operating instructions can be found at [www.wenglor.com](http://www.wenglor.com) in the product's separate download area.

Read the operating instructions carefully before using the product.

Protect the sensor against contamination and mechanical influences.

---

## 2.6 Approvals and protection classes

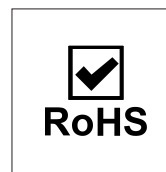
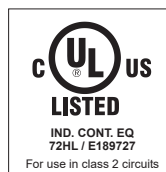
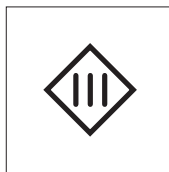

## 3 Technical Data

### 3.1 General Information

#### Inductive analysis module

	INTT323
<b>Inductive data</b>	
Switching Distance	40 mm
Use	With INTT320
<b>Electrical data</b>	
Supply Voltage	10...30 V DC
Supply Voltage with IO-Link	18...30 V DC
Current Consumption (U <sub>b</sub> = 24 V)	< 15 mA
Switching Frequency	50 Hz
Temperature Drift	< 10 %
Analysis module temperature range	0...70 °C
Number of Switching Outputs	2
Switching Output Voltage Drop	< 1.5 V
Switching Output/Switching Current	100 mA
Residual Current Switching Output	< 100 µA
Short Circuit Protection	yes
Reverse Polarity Protection	yes
Overload Protection	yes
Interface	IO-Link V1.1
Protection Class	III
<b>Technical Specifications</b>	
Analysis module material	Stainless steel, V2A (1.4305 / 303)
Degree of protection, analysis module	IP65
Degree of protection for push-pull connector	IP50 IP51*
Connection	M12 × 1; 4-pin
Cable length (L)	5 m
Cable Jacket Material	Plastic, PFA
Outer diameter cable	3.4 mm
Bending Radius	> 17 mm
PWIS-free	yes
<b>Safety technology data</b>	
MTTFd (EN ISO 13849-1)	3706.54 a
<b>Function</b>	
Error Indicator	yes
Programmable switching distance	30/35/40 mm
<b>output function</b>	
Output	PNP Error Output
Circuit	NO
<b>Adjustable parameters</b>	

INTT323	
Output	Error Output Push-pull NPN PNP
Circuit	NC NC+NO NO
<b>General Data</b>	
Scope of delivery	1 × analysis module 1 × initial start-up instructions 1 × MUTTER-M18-E003 hex nut

\* IP51 only when the sensor head is mounted with the active surface facing upward (water droplets falling from above).

### Compatible sensor head (sold separately)

INTT320	
<b>Inductive data</b>	
Switching Distance	40 mm
Standard Target	120 × 120 mm
Correction Factors Stainless Steel V2A/CuZn/Al	1,10/0,65/0,58
Mounting	Non-flush
Mounting A/B/C/D in mm	30/130/80/20
Mounting B1 in mm	0...70
Switching Hysteresis	< 10 %
Use	With INTT3xx analysis module
<b>Electrical data</b>	
Sensor head temperature range	-10...250 °C
Service Life (T = +200 °C)	100000 h
Service Life (T = +250 °C)	60000 h
<b>Mechanical data</b>	
Sensing face	Plastic, PEEK
Sensor head material	Stainless steel, V2A (1.4305 / 303)
Degree of Protection	IP50 IP51*
PWIS-free	yes
<b>output function</b>	
Output	PNP Error Output
Circuit	NO
<b>Function</b>	
Programmable switching distance	30/35/40 mm
<b>General data</b>	
Scope of delivery	1 × initial start-up instructions 1 × sensor head

\* IP51 only when the sensor head is mounted with the active surface facing upward (water droplets falling from above).

## 3.2 Housing Dimensions

### Analysis module

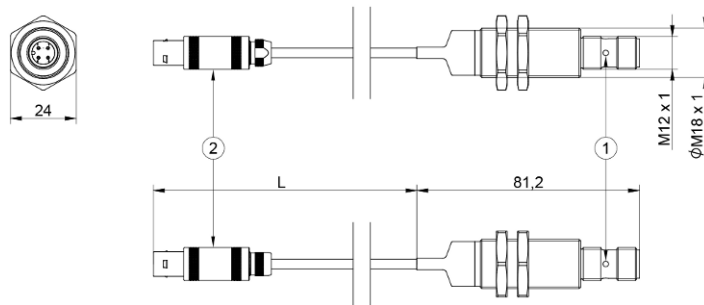

- ① Switching Status Indicator
- ② Push-pull plug connectors

### Compatible sensor head (sold separately)

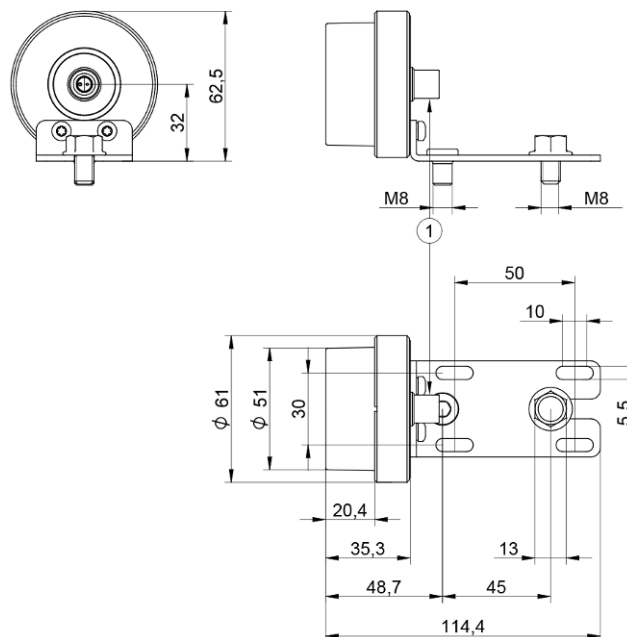

- ① Push-pull plug connectors

Dimensions in mm (1 mm = 0.03937 inch)

### 3.3 Control panel

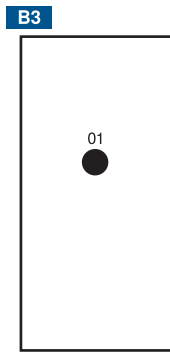

01 = Switching Status Indicator

### 3.4 Complementary Products

wenglor offers you the right connection and mounting technology as well as other accessories for your product. You can find this at [www.wenglor.com](http://www.wenglor.com) on the product details page at the bottom.

## 4 Transport and Storage

### 4.1 Transport

Upon receipt of shipment, the goods must be inspected for damage in transit. In the case of damage, conditionally accept the package and notify the manufacturer of the damage. Then return the device, making reference to damage in transit.

### 4.2 Storage

The following points must be taken into consideration with regard to storage:

- Do not store the product outdoors.
- Store the product in a dry, dust-free place.
- Protect the product against mechanical impacts.
- Protect the product against exposure to direct sunlight.



#### NOTICE

#### **Risk of property damage in case of improper storage!**

The product may be damaged.

→ Storage instructions must be complied with.

---

# 5 Installation and Electrical Connection

## 5.1 Installation

- Protect the product from contamination during installation.
- Observe all applicable electrical and mechanical regulations, standards, and safety rules.
- Protect the product against mechanical influences.
- Make sure that the sensor is mounted in a mechanically secure fashion.
- Specified torque values must be complied with (see section Technical Data [► 8]).
- Both the sensor cable and the connection line must be routed separately from power cables (e.g., frequency converters).
- The sensor cable is not suitable for use in drag chains and must not be crushed.
- When routing the cable, ensure that the bending radius is not less than five times the cable diameter (see section Technical Data [► 8]).



### NOTICE

Ensure that the plug does not heat up to over 70 °C.



### NOTICE

The cable is connected to the sensor head via the push-pull plug connector. When connecting, pay attention to the orientation of the pins.



### NOTICE

Design measures must be taken to ensure that no torsional stresses occur between the push-pull plug connector and the cable.



### NOTICE

To disconnect the plug, the release sleeve must be pulled back. Pulling on the cable will damage the sensor!

- Installation instructions must be observed (see Technical Data [► 8] section).



### NOTICE

#### **Risk of property damage in case of improper installation!**

The product may be damaged!

- Comply with installation instructions.



### **CAUTION**

#### **Risk of personal injury or property damage during installation!**

Personal injury and damage to the product may occur.

- Ensure a safe installation environment.

## 5.1.1 Installation using a quick-release fastener

### Initial installation

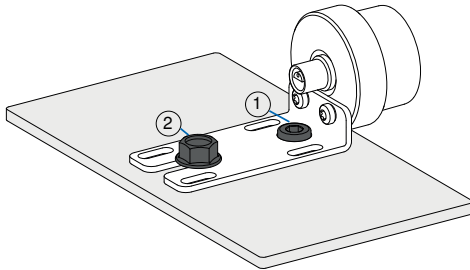

- Screw the M8 hex head cap screw (1) into the designated mounting position and place the pre-assembled mounting bracket of the sensor head onto the installed M8 hex head cap screw (thread it on). Now position the sensor head in the desired orientation.
- Secure the position by tightening the M8 hex head cap screw (2).

### Sensor Replacement



#### INFORMATION

It is not necessary to loosen the M8 cylinder head bolt (1) when removing or replacing the sensor head.

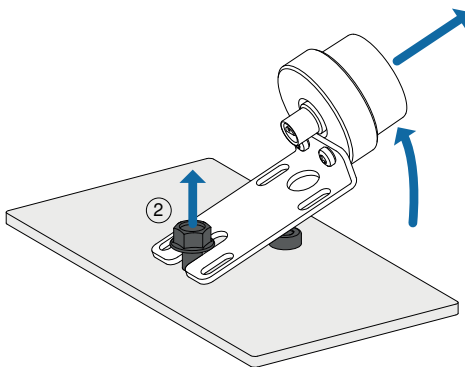

- To replace the sensor head, slightly loosen the M8 hex head screw (2). It is not necessary to unscrew it completely.
- Lift the mounting bracket together with the sensor head and pull it off. Now insert the new sensor head and secure it as described above.



#### NOTICE

Sensor head sold separately.

## 5.1.2 Other Installation Options

Precise positioning is possible thanks to the screws in the four slotted holes. Loosen these slightly. You can now slide the sensor back and forth until it is perfectly aligned. Then tighten the screws again.



#### NOTICE

Sensor head sold separately.

## 5.2 Installation for IP51

The IP51 degree of protection applies only when the sensor head is mounted with the active surface facing upward. In this case, water must drip from above.

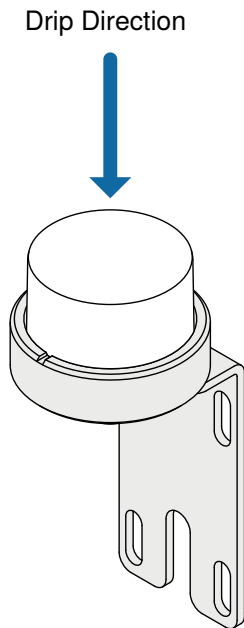

## 5.3 Installation Instructions

### 5.3.1 Installation Instructions for Sensors with weproTec

weproTec is the abbreviation for wenglor proximity switch technology, an innovative, patented wenglor technology for inductive sensors.

Inductive sensors with weproTec can be mounted very close to each other (→ installation dimension B1) or opposite each other ( $1.5 \times S_n$ ). There is no mutual interference between the sensors in the defined areas.

The installation instructions according to the standard (see section Installation instructions according to standard) also apply.

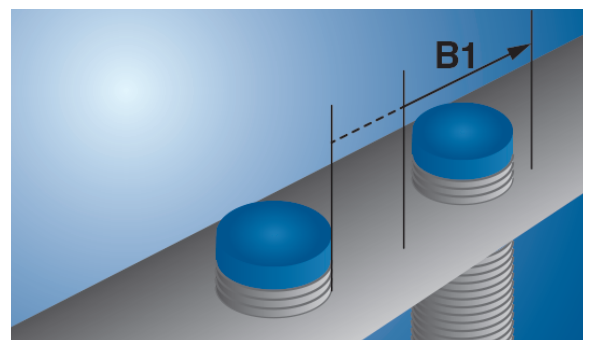
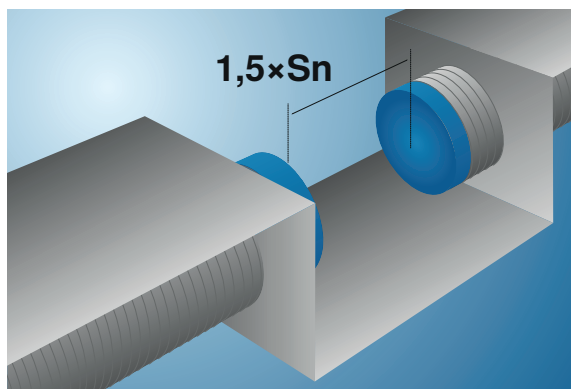

Installation dimension	Description
A	Minimum distance from the sensor to the damping material (e.g., steel).
B	Minimum distance between two inductive sensors. The distance applies to installation in air. If the sensors are installed in an attenuating material (e.g., steel), the distance is reduced. The exact distance must be tested in the application.
B	Additional minimum distance between two inductive sensors. The distance applies to installation in air. If the sensors are installed in an attenuating material (e.g., steel), the distance is reduced. The exact distance must be tested in the application.

C	Minimum distance between the active surface of the inductive sensor and the damping material (e.g., steel). The distance C does not refer to the object to be detected, but to the background. The object to be detected is detected within the switching distance.
D	Minimum dimension by which the sensor (active surface) must protrude from the damping material (e.g., steel).
$1.5 \times S_n$	Opposite installation. Two identical sensors must be mounted at this minimum distance.

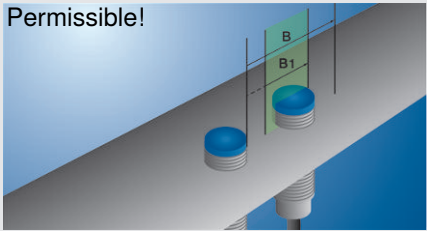
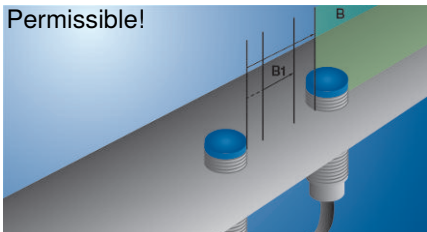
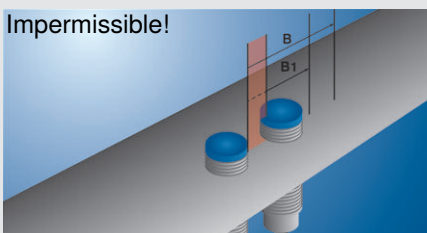
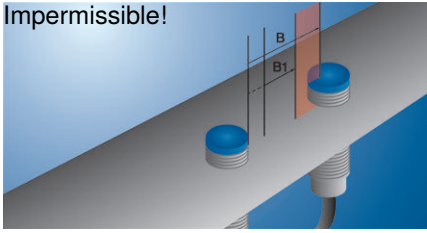
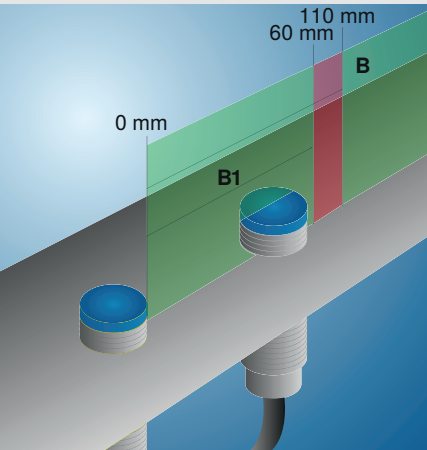
Installation variant	Description
	Two sensors can be mounted next to each other in area B1.
	Two sensors can be mounted next to each other from installation dimension B.
	Two sensors must not be mounted next to each other in front of area B1.
	Two sensors must not be mounted in the area between B1 and B.
	<p>Example: B1 starts at 0 mm Installation B1 in mm: 0...60</p> <ul style="list-style-type: none"> <li>• Installation A/B/C/D in mm: x/110/x/x</li> <li>• Not allowed area: 60...110 mm</li> </ul>

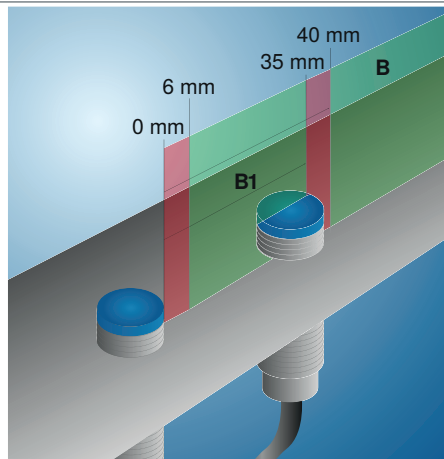

Example: B1 does not start at 0 mm

- Installation B1 in mm: 6...35
- Installation A/B/C/D in mm: x/40/x/x

## 5.4 Electrical Connection

- Wire the sensor in accordance with the connection diagram.
- Switch on the supply voltage (see section Technical Data [► 8])
- If using IO-Link, connect the sensor to 18...30 V DC.
- If not using IO-Link, connect the sensor to 10...30 V DC.



### DANGER

#### Risk of personal injury or property damage due to electric current.

Voltage-conducting parts may cause personal injury or damage to equipment.

→ The electric device may be connected by appropriately qualified personnel only.

704

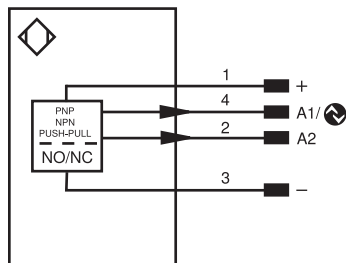

Legend					
+	Supply Voltage +	PT	Platinum measuring resistor	ENARs422	Encoder A/Ā (TTL)
–	Supply Voltage 0 V	nc	Not connected	ENBRs422	Encoder B/B̄ (TTL)
~	Supply Voltage (AC Voltage)	U	Test Input	ENA	Encoder A
A	Switching Output (NO)	Ū	Test Input inverted	ENb	Encoder B
Ā	Switching Output (NC)	W	Trigger Input	AMIN	Digital output MIN
V	Contamination/Error Output (NO)	W–	Ground for the Trigger Input	AMAX	Digital output MAX
Ṽ	Contamination/Error Output (NC)	O	Analog Output	AOK	Digital output OK
E	Input (analog or digital)	O–	Ground for the Analog Output	SY In	Synchronization In
T	Teach Input	BZ	Block Discharge	SY OUT	Synchronization OUT
R	Reset input	AMv	Valve Output	OLT	Brightness output
Z	Time Delay (activation)	a	Valve Control Output +	M	Maintenance
S	Shielding	b	Valve Control Output 0 V	rsv	Reserved
RxD	Interface Receive Path	SY	Synchronization	Wire Colors according to DIN IEC 60757	
TxD	Interface Send Path	SY–	Ground for the Synchronization	BK	Black
RDY	Ready	E+	Receiver-Line	BN	Brown
GND	Ground	S+	Emitter-Line	RD	Red
CL	Clock	⊕	Grounding	OG	Orange
E/A	Output/Input programmable	SnR	Switching Distance Reduction	YE	Yellow
	IO-Link	Rx+/-	Ethernet Receive Path	GN	Green
PoE	Power over Ethernet	Tx+/-	Ethernet Send Path	BU	Blue
IN	Safety Input	Bus	Interfaces-Bus A(+)/B(-)	VT	Violet
OSSD	Safety Output	La	Emitted Light disengageable	GY	Grey
Signal	Signal Output	Mag	Magnet activation	WH	White
BI_D+/-	Ethernet Gigabit bidirect. data line (A-D)	RES	Input confirmation	PK	Pink
EN0 RS422	Encoder 0-pulse 0/0̄ (TTL)	EDM	Contacting Monitoring	GNYE	Green/Yellow

## 5.5 Troubleshooting

The sensors integrate an error indicator (flashes continuously at 5 Hz). Possible causes for the error message (LED) are:

Error	Possible cause	Remedy
Error	Short circuit on output 1	Check the wiring and eliminate the short circuit
	Mechanical damage to the coil	Replace sensor



### INFORMATION

#### Action in case of error:

1. Take the machine out of service.
2. Analyze and rectify the cause of the error using the diagnostic information.
3. If the fault cannot be rectified, contact wenglor support.
4. Do not operate the machine if the error behavior is unclear.
5. The machine must be taken out of service if the error cannot be clearly identified or reliably rectified.



### DANGER

#### Risk of personal injury or property damage if not observed!

The safety function of the system is disabled. Damage to personnel and equipment.

- Behavior in case of error as specified.

## 6 Settings via IO-Link

The sensors can exchange parameters and process data via IO-Link. The parameters can be used to make many additional settings on the device. The process data transmit cyclical data and condition monitoring.

To this end, the sensor is connected to a suitable IO-Link master (see product detail page/complementary products). The interface protocol and the IO-Link data sheet can be found at [www.wenglor.com](http://www.wenglor.com) in the download area for the respective product.

### Process data:

- Object detected
- error indicator

### Parameter data:

- Switching distance (3 selectable)
- Output function A1 (PNP, NPN, push-pull)
- Switching function A1 (NO, NC)
- Switching function A2 (antivalent, error output NO, error output NC, no output)

## 7 Maintenance Instructions



### NOTICE

This wenglor product is maintenance-free.

Cleaning and inspection of the plug connections at regular intervals are advisable.

Do not clean the product with solvents or cleaning agents that could damage the product.

The product must be protected against contamination during initial start-up.

---

## 8 Proper Disposal

wenglor sensoric GmbH does not accept the return of unusable or irreparable products. Respectively valid national waste disposal regulations apply to product disposal.

## 9 **Declarations of Conformity**

Declarations of conformity can be found on our website at [www.wenglor.com](http://www.wenglor.com) in the product's separate download area.