

Operating Instructions

P1HJ004

Fork Sensor



EN



Table of Contents

1	General	3
1.1	Information Concerning these Instructions.....	3
1.2	Explanation of Symbols.....	3
1.3	Limitation of Liability.....	4
1.4	Copyrights.....	4
2	For Your Safety	5
2.1	Use for Intended Purpose.....	5
2.2	Use for Other than the Intended Purpose.....	5
2.3	Personnel Qualifications.....	5
2.4	Modification of Products.....	6
2.5	General Safety Precautions	6
2.6	Laser Warnings	6
2.7	Approvals and protection classes.....	6
3	Technical Data	7
3.1	General data.....	7
3.2	Default Settings.....	8
3.3	Housing Dimensions	8
3.4	Control panel.....	9
3.5	Complementary Products	9
3.6	Scope of delivery	9
4	Transport and Storage	10
4.1	Transport	10
4.2	Storage	10
5	Installation and Electrical Connection	11
5.1	Electrical Connection	11
5.2	Installation	11
6	Settings	13
6.1	Mode selection.....	13
6.2	Teach-in.....	13
7	Maintenance Instructions	15
8	Proper Disposal	16
9	Declarations of Conformity	17

1 General

1.1 Information Concerning these Instructions

- These instructions make it possible to use the product safely and efficiently.
- These instructions are an integral part of the product and must be kept on hand for the entire duration of its service life.
- Local accident prevention regulations and national work safety regulations must be complied with as well.
- The product is subject to further technical development, and thus the information contained in these operating instructions may also be subject to change. The current version can be found at www.wenglor.com in the product's separate download area.



INFORMATION

The operating instructions must be read carefully before using the product and must be kept on hand for later reference.

1.2 Explanation of Symbols

- Safety precautions and warnings are emphasized by means of symbols and signal words.
- Safe use of the product is only possible if these safety precautions and warnings are adhered to.

The safety precautions and warnings are laid out in accordance with the following principle:

SIGNAL WORD

Type and source of danger!

Possible consequences in the event that the hazard is disregarded.

→ Measures for averting the hazard.

The meanings of the signal words, as well as the scope of the associated hazards, are listed below:



DANGER

This signal word indicates a hazard with a high degree of risk which, if not avoided, results in death or severe injury.



WARNING

This signal word indicates a hazard with a medium degree of risk which, if not avoided, may result in death or severe injury.



CAUTION

This signal word indicates a hazard with a low degree of risk which, if not avoided, may result in minor or moderate injury.



NOTICE

This signal word draws attention to a potentially hazardous situation which, if not avoided, may result in property damage.



INFORMATION

Information draws attention to useful tips and suggestions, as well as information on efficient, error-free use.

1.3 Limitation of Liability

- The product has been developed in consideration of the current state-of-the-art technology, as well as applicable standards and guidelines. Subject to change without notice.
- A valid declaration of conformity can be accessed at www.wenglor.com in the product's separate download area.
- wenglor sensoric elektronische Geräte GmbH (hereinafter referred to as "wenglor") excludes all liability in the event of:
 - Non-compliance with the instructions
 - Use of the product for purposes other than those intended.
 - Use by untrained personnel.
 - Use of unapproved spare parts.
 - Unapproved modification of products.
- These operating instructions do not include any guarantees from wenglor with regard to the described procedures or specific product characteristics.
- wenglor assumes no liability for printing errors or other inaccuracies contained in these operating instructions unless wenglor was verifiably aware of such errors at the point in time at which the operating instructions were prepared.

1.4 Copyrights

- The contents of these instructions are protected by copyright law.
- All rights are reserved by wenglor.
- Commercial reproduction or any other commercial use of the provided content and information, in particular graphics and images, is not permitted without previous written consent from wenglor.

2 For Your Safety

2.1 Use for Intended Purpose

Fork sensor

These fork sensor operate with a collimated laser beam. The emitter and receiver are arranged opposite each other in a stainless steel housing. If the light beam is interrupted, the output switches.

Fork sensor with collimated laser light beams are particularly suitable for detecting very small objects or clear glass.

This Product Can Be Used in the Following Industry Sectors:

- Special-purpose mechanical engineering
- Heavy mechanical engineering
- Logistics
- Automotive industry
- Food industry
- Packaging industry
- Pharmaceuticals industry
- Plastics industry
- Woodworking industry
- Consumer goods industry
- Paper industry
- Electronics industry
- Glass industry
- Steel industry
- Aviation industry
- Chemicals industry
- Alternative energies
- Raw materials extraction

2.2 Use for Other than the Intended Purpose

- Not a safety component in accordance with 2006/42/EC (Machinery Directive).
- The product is not suitable for use in potentially explosive atmospheres.
- The product may be used only with accessories supplied or approved by wenglor, or in combination with approved products. A list of approved accessories and combination products can be found at www.wenglor.com on the product detail page.



DANGER

Risk of personal injury or property damage in case of use for other than the intended purpose!

Use for other than the intended purpose may lead to hazardous situations.

→ Observe instructions regarding use for intended purpose.

2.3 Personnel Qualifications

- Suitable technical training is a prerequisite.
- In-house electronics training is required.
- Trained personnel who use the product must have (permanent) access to the operating instructions.



DANGER

Risk of personal injury or property damage in case of incorrect initial start-up and maintenance!

Personal injury and damage to equipment may occur.

→ Adequate training and qualification of personnel

2.4 Modification of Products



DANGER

Risk of personal injury or property damage if the product is modified!

Personal injury and damage to equipment may occur. Noncompliance may result in loss of the CE and/or UKCA mark and voiding of the warranty.

→ Modification of the product is not permitted

2.5 General Safety Precautions



INFORMATION

These instructions are an integral part of the product and must be kept on hand for the entire duration of its service life.

In the event of possible changes, the current version of the operating instructions can be found at www.wenglor.com in the product's separate download area.

Read the operating instructions carefully before using the product.

Protect the sensor against contamination and mechanical influences.

2.6 Laser Warnings



Laser Class 1 (EN 60825-1)

Applicable standards and safety regulations must be observed.

2.7 Approvals and protection classes

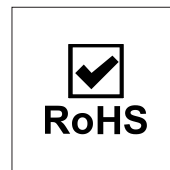
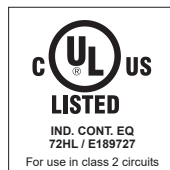
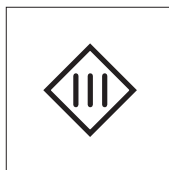

3 Technical Data

3.1 General data

	P1HJ004
Optical data	
Fork Width	120 mm
Smallest Recognizable Part	40 µm
Smallest Detectable Gap	50 µm
Switching Hysteresis	< 10 %
Light Source	Laser (red)
Service Life (T = +25 °C)	100000 h
Laser Class (EN 60825-1)	1
Light Spot Diameter	0.35 mm
Max. Ambient Light	10000 Lux
Repeat Accuracy	< 5 µm
Electrical data	
Supply Voltage	10...30 V DC
Current Consumption (U _b = 24 V)	< 20 mA
Switching Frequency	10 kHz
Response Time	50 µs
Temperature Range	-25...60 °C
Switching Output Voltage Drop	< 2.5 V
PNP Switching Output/Switching Current	100 mA
Short Circuit Protection	yes
Reverse Polarity Protection	yes
Overload Protection	yes
Teach Mode	NT, MT
Protection Class	III
Mechanical data	
Setting Method	Teach-In
Housing Material	Stainless steel, V4A (1.4404 / 316L)
Optic Cover	Plastic
Degree of Protection	IP69K
Connection	M8 × 1; 4-pin
Safety technology data	
MTTFd (EN ISO 13849-1)	1615.89 a
General data	
Approvals	Ecolab FDA compliant
output function	
Output	PNP
Circuit	NO
Adjustable parameters	
Circuit	NC NC/NO NO

3.2 Default Settings

Technical data	
switching output	NO
Time delay	0 ms
teach-in mode	NT

Ohne Objekt

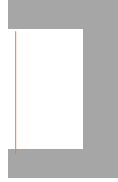

Mit Objekt

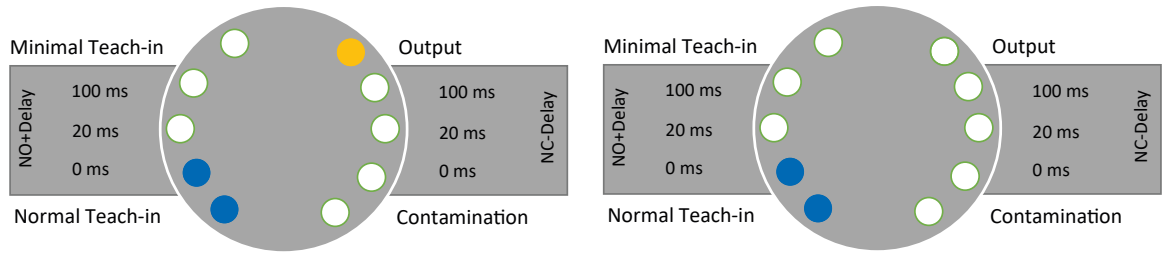

3.3 Housing Dimensions

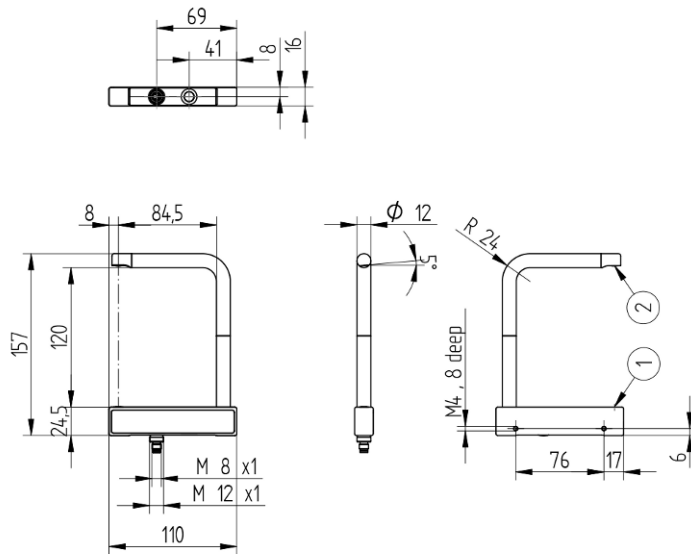

- ① Emitter
- ② Receiver

Screw M4 = 1 Nm

Dimensions in mm (1 mm = 0.03937 inch)

3.4 Control panel

II5

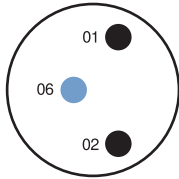

01 = Switching Status Indicator
02 = Contamination Warning
20 = Enter key
36 = Mode Indicator

3.5 Complementary Products

wenglor offers you the right connection and mounting technology as well as other accessories for your product. You can find this at www.wenglor.com on the product details page at the bottom.

3.6 Scope of delivery

- Sensor
- Safety precaution

4 Transport and Storage

4.1 Transport

Upon receipt of shipment, the goods must be inspected for damage in transit. In the case of damage, conditionally accept the package and notify the manufacturer of the damage. Then return the device, making reference to damage in transit.

4.2 Storage

The following points must be taken into consideration with regard to storage:

- Do not store the product outdoors.
- Store the product in a dry, dust-free place.
- Protect the product against mechanical impacts.
- Protect the product against exposure to direct sunlight.



NOTICE

Risk of property damage in case of improper storage!

The product may be damaged.

→ Storage instructions must be complied with.

5 Installation and Electrical Connection

5.1 Electrical Connection

- Wire the sensor in accordance with the connection diagram.
- Switch on the supply voltage (see section Technical Data [▶ 7])



DANGER

Risk of personal injury or property damage due to electric current.

Voltage-conducting parts may cause personal injury or damage to equipment.

→ The electric device may be connected by appropriately qualified personnel only.

152

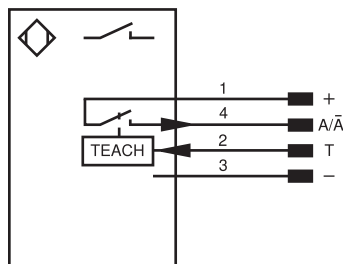

Legend

+	Supply Voltage +
-	Supply Voltage 0 V
~	Supply Voltage (AC Voltage)
A	Switching Output (NO)
Ā	Switching Output (NC)
V	Contamination/Error Output (NO)
∇	Contamination/Error Output (NC)
E	Input (analog or digital)
T	Teach Input
Z	Time Delay (activation)
s	Shielding
RxD	Interface Receive Path
TxD	Interface Send Path
RDY	Ready
GND	Ground
CL	Clock
E/A	Output/Input programmable
	IO-Link
PoE	Power over Ethernet
IN	Safety Input
OSSD	Safety Output
Signal	Signal Output
BI_D+/-	Ethernet Gigabit bidirect. data line (A-D)
ENoRS422	Encoder 0-pulse 0-0 (TTL)

PT	Platinum measuring resistor
nc	not connected
U	Test Input
Ū	Test Input inverted
W	Trigger Input
W-	Ground for the Trigger Input
O	Analog Output
O-	Ground for the Analog Output
BZ	Block Discharge
AWV	Valve Output
a	Valve Control Output +
b	Valve Control Output 0 V
SY	Synchronization
SY-	Ground for the Synchronization
E+	Receiver-Line
S+	Emitter-Line
⊥	Grounding
SnR	Switching Distance Reduction
Rx+/-	Ethernet Receive Path
Tx+/-	Ethernet Send Path
B _{US}	Interfaces-Bus A(+)/B(-)
La	Emitted Light disengageable
Mag	Magnet activation
RES	Input confirmation
EDM	Contacting Monitoring

EN _{AR} S422	Encoder A/Ā (TTL)
EN _{BR} S422	Encoder B/B̄ (TTL)
ENA	Encoder A
ENB	Encoder B
A _{MIN}	Digital output MIN
A _{MAX}	Digital output MAX
A _{OK}	Digital output OK
SY _{IN}	Synchronization In
SY _{OUT}	Synchronization OUT
O _{LT}	Brightness output
M	Maintenance
rsv	reserved
Wire Colors according to IEC 60757	
BK	Black
BN	Brown
RD	Red
OG	Orange
YE	Yellow
GN	Green
BU	Blue
VT	Violet
GY	Grey
WH	White
PK	Pink
GN _{YE}	Green/Yellow

5.2 Installation

- Protect the product from contamination during installation.
- Relevant electrical and mechanical regulations, standards, and safety rules must be observed.
- Protect the product from mechanical impact.
- Ensure that the sensor is mechanically secure.
- Torque values must be observed (see section Technical Data [▶ 7]).



NOTICE

Risk of property damage in case of improper installation!

The product may be damaged!

→ Comply with installation instructions.



CAUTION

Risk of personal injury or property damage during installation!

Personal injury and damage to the product may occur.

→ Ensure a safe installation environment.

6 Settings

6.1 Mode selection

	<p>Press the button for >5 seconds until a blue LED flashes.</p>
	<p>Press briefly until the LED for the desired setting lights up. Press for >5 seconds to accept the setting.</p>

After 15 seconds without pressing any buttons, the sensor will enter Run mode with the previous settings.

6.2 Teach-in

	<p>Press the button for 2 seconds; the LED flashes and the teach-in is performed in the set modes.</p>
--	--

After 15 seconds without pressing any buttons, the sensor enters run mode with the previous settings.

Clear glass detection:

To detect clear transparent objects (glass, foils), select Minimal teach-in. Before performing the Minimal teach-in, please wait for the self-heating time of approx. 5 minutes.

Normally closed (NC):

Output switched when light beam is interrupted.

Normally open (NO):

Output switched when barrier is clear.

Time delay:

Extension of the switching duration based on the interruption of the light beam. This is useful for slow analysis modules.

Functions of pin 2

External teach / mode selection:

Teach-in and mode selection can also be set via the input using the same procedure as with the teach-in key. An activated input (10...30 V DC) corresponds to a pressed teach-in button.

Locking:

If the teach-in input is permanently (>31 sec) set to 10...30 V DC, the sensor is locked and protected against unintentional adjustment.

7 Maintenance Instructions



NOTICE

This wenglor product is maintenance-free.

Regular cleaning and checking of the plug connections is recommended.

Do not use solvents or cleaners that could damage the product to clean it.

Only use a clean, soft microfiber cloth to clean the emitter and receiver optics. To avoid damaging the seal, clean using a circular motion.

The product must be protected from contamination during initial start-up.

8 Proper Disposal

wenglor sensoric GmbH does not accept the return of unusable or irreparable products. Respectively valid national waste disposal regulations apply to product disposal.

9 **Declarations of Conformity**

Declarations of conformity can be found on our website at www.wenglor.com in the product's separate download area.