

Operating Instructions

P3PC142

Laser Distance Sensor Triangulation

inspect
award 2024



EN



Table of Contents

1	General	4
1.1	Information Concerning these Instructions	4
1.2	Explanation of Symbols	4
1.3	Limitation of Liability	5
1.4	Copyrights	5
2	For Your Safety	6
2.1	Use for Intended Purpose	6
2.2	Use for Other than the Intended Purpose	6
2.3	Personnel Qualifications	6
2.4	Modification of Products	7
2.5	General Safety Precautions	7
2.6	Laser Warnings	7
2.7	Approvals and Protection Class	8
3	Technical Data	9
3.1	General Data	9
3.1.1	Light Spot Diameter	10
3.2	Warm-Up Phase	10
3.3	Housing Dimensions	10
3.4	Control Panel	11
3.5	Complementary Products	11
3.6	Scope of delivery	11
4	Transport and Storage	12
4.1	Transport	12
4.2	Storage	12
5	Installation and Electrical Connection	13
5.1	Installation	13
5.2	Adjustment	14
5.3	Electrical Connection	16
5.4	Diagnosis	17
5.5	Troubleshooting	18
6	Settings	19
6.1	Configuration with Push of Button / Teach-In	19
7	Settings via menu	21
8	Function Description	24
8.1	Sensor Functions	24
8.2	Display Functions	26
8.3	Input/Output Functions (E/A)	26
8.3.1	Pin Function	26
8.4	Output Functions	27
8.5	Input Functions	29
8.6	Switching Point Functions (SSC1/SSC2)	29
8.7	Differential and Thickness Measurement	32
8.8	Condition Monitoring Functions	37
8.8.1	Status Message Function	37

8.8.2	Warning/Error Output Function	37
8.8.3	Simulation Functions	38
9	Bluetooth	39
9.1	weCon Installation	39
9.2	Establishing Connection with Sensor	39
9.3	Using the weCon App.....	40
10	IO-Link	41
10.1	Parameters.....	41
10.2	Condition Monitoring/Process Data.....	41
10.2.1	Process Data In.....	41
10.2.2	Process Data Out.....	41
10.2.3	Events.....	41
11	wTeach2 Configuration Software.....	43
11.1	Calling Up the Calibration Protocol.....	43
12	Maintenance Instructions	45
13	Proper Disposal	46
14	Declarations of Conformity.....	47

1 General

1.1 Information Concerning these Instructions

- These instructions make it possible to use the product safely and efficiently.
- These instructions are an integral part of the product and must be kept on hand for the entire duration of its service life.
- Local accident prevention regulations and national work safety regulations must be complied with as well.
- The product is subject to further technical development, and thus the information contained in these operating instructions may also be subject to change. The current version can be found at www.wenglor.com in the product's separate download area.



INFORMATION

The operating instructions must be read carefully before using the product and must be kept on hand for later reference.

1.2 Explanation of Symbols

- Safety precautions and warnings are emphasized by means of symbols and signal words.
- Safe use of the product is only possible if these safety precautions and warnings are adhered to.

The safety precautions and warnings are laid out in accordance with the following principle:

SIGNAL WORD

Type and source of danger!

Possible consequences in the event that the hazard is disregarded.

→ Measures for averting the hazard.

The meanings of the signal words, as well as the scope of the associated hazards, are listed below:



DANGER

This signal word indicates a hazard with a high degree of risk which, if not avoided, results in death or severe injury.



WARNING

This signal word indicates a hazard with a medium degree of risk which, if not avoided, may result in death or severe injury.



CAUTION

This signal word indicates a hazard with a low degree of risk which, if not avoided, may result in minor or moderate injury.



NOTICE

This signal word draws attention to a potentially hazardous situation which, if not avoided, may result in property damage.



INFORMATION

Information draws attention to useful tips and suggestions, as well as information on efficient, error-free use.

1.3 Limitation of Liability

- The product has been developed in consideration of the current state-of-the-art technology, as well as applicable standards and guidelines. Subject to change without notice.
- A valid declaration of conformity can be accessed at www.wenglor.com in the product's separate download area.
- wenglor sensoric elektronische Geräte GmbH (hereinafter referred to as "wenglor") excludes all liability in the event of:
 - Non-compliance with the instructions
 - Use of the product for purposes other than those intended.
 - Use by untrained personnel.
 - Use of unapproved spare parts.
 - Unapproved modification of products.
- These operating instructions do not include any guarantees from wenglor with regard to the described procedures or specific product characteristics.
- wenglor assumes no liability for printing errors or other inaccuracies contained in these operating instructions unless wenglor was verifiably aware of such errors at the point in time at which the operating instructions were prepared.

1.4 Copyrights

- The contents of these instructions are protected by copyright law.
- All rights are reserved by wenglor.
- Commercial reproduction or any other commercial use of the provided content and information, in particular graphics and images, is not permitted without previous written consent from wenglor.

2 For Your Safety

2.1 Use for Intended Purpose

Laser Distance Sensors Triangulation

Triangulation laser distance sensors work according to the principle of angle measurement, where the object's color, shape, and surface do not affect the measurement. Depending on the setting, they can be operated at very high speed or resolution. The measuring range can be selected individually within the sensor's working range.

This Product Can Be Used in the Following Industry Sectors:

- Special-purpose mechanical engineering
- Heavy mechanical engineering
- Logistics
- Automotive industry
- Food industry
- Packaging industry
- Pharmaceuticals industry
- Plastics industry
- Woodworking industry
- Consumer goods industry
- Paper industry
- Electronics industry
- Glass industry
- Steel industry
- Aviation industry
- Chemicals industry
- Alternative energies
- Raw materials extraction

2.2 Use for Other than the Intended Purpose

- Not a safety component in accordance with 2006/42/EC (Machinery Directive).
- The product is not suitable for use in potentially explosive atmospheres.
- The product may be used only with accessories supplied or approved by wenglor, or in combination with approved products. A list of approved accessories and combination products can be found at www.wenglor.com on the product detail page.



DANGER

Risk of personal injury or property damage in case of use for other than the intended purpose!

Use for other than the intended purpose may lead to hazardous situations.

→ Observe instructions regarding use for intended purpose.

2.3 Personnel Qualifications

- Suitable technical training is a prerequisite.
- In-house electronics training is required.
- Trained personnel who use the product must have (permanent) access to the operating instructions.



DANGER

Risk of personal injury or property damage in case of incorrect initial start-up and maintenance!

Personal injury and damage to equipment may occur.

→ Adequate training and qualification of personnel

2.4 Modification of Products



DANGER

Risk of personal injury or property damage if the product is modified!

Personal injury and damage to equipment may occur. Noncompliance may result in loss of the CE and/or UKCA mark and voiding of the warranty.

→ Modification of the product is not permitted

2.5 General Safety Precautions



INFORMATION

These instructions are an integral part of the product and must be kept on hand for the entire duration of its service life.

In the event of possible changes, the current version of the operating instructions can be found at www.wenglor.com in the product's separate download area.

Read the operating instructions carefully before using the product.

Protect the sensor against contamination and mechanical influences.

2.6 Laser Warnings

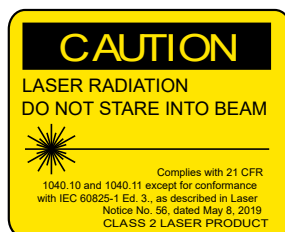
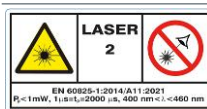

Laser Class 2 (EN 60825-1)

Applicable standards and safety regulations must be observed. The accompanying laser warnings must be attached. Do not look into the laser beam.

2.7 Approvals and Protection Class

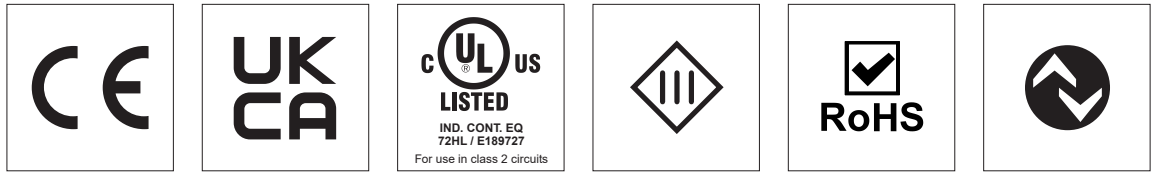

NOTICE

This equipment has been tested and found to comply with the limits for a Class A digital device, pursuant to part 15 of the FCC Rules. These limits are designed to provide reasonable protection against harmful interference when the equipment is operated in a commercial environment. This equipment generates, uses, and can radiate radio frequency energy and, if not installed and used in accordance with the instruction manual, may cause harmful interference to radio communications. Operation of this equipment in a residential area is likely to cause harmful interference in which case the user will be required to correct the interference at his own expense.

This device complies with part 15 of the FCC Rules.

Operation is subject to the following two conditions:

- (1) This device may not cause harmful interference, and
- (2) this device must accept any interference received, including interference that may cause undesired operation.

FCC Caution: Any changes or modifications not expressly approved by the party responsible for compliance could void the user's authority to operate this equipment.

3 Technical Data

3.1 General Data

Technical Data	
Optical Data	
Working Range	40 ... 240 mm
Measuring Range	40 ... 240 mm
Reproducibility maximum	40 µm
Reproducibility: 1 Sigma	4 µm
Linearity Deviation	200 µm
Light Source	Laser (blue)
Wavelength	405 nm
Service Life (T = +25 °C)	100000 h
Laser Class (EN 60825-1)	2
Max. Ambient Light	5000 Lux
Light Spot Diameter	See section Light Spot Diameter [► 10]
Electrical Data	
Supply Voltage	18 ... 30 V DC
Current Consumption (U _b = 24 V)	< 70 mA
Measuring Rate	2500 /s
Response Time	< 0.5 ms
Temperature Drift	< 15 µm/K
Temperature Range	0 ... 60 °C
Analog Output	0...10 V
Short Circuit and Overload Protection	yes
Reverse Polarity Protection	yes
Interface	IO-Link V1.1
Baud Rate	COM3
Protection Class	III
FDA Accession Number	2310698-000
Mechanical Data	
Setting Method	(OLED)/Bluetooth menu
Housing Material	Aluminum, anodised Plastic, ABS
Optic Cover	Plastic, PMMA
Degree of Protection	IP67
Connection	M12 × 1; 4/5-pin
Contains FCC ID: 2A30LDC1392	x
Output Functions	
Output	Analog Output
Technical Safety Data	
MTTFd (EN ISO 13849-1)	398.5 a



NOTICE

The information on accuracy (linearity deviation, reproducibility and temperature drift) refers to the measured values transmitted via IO-Link.

If an analog output is used, its deviation must be taken into account when considering accuracy. The maximum deviation here is:

Analog output 0...10 V: ± 15 mV at >5 kOhm load

Analog output 4...20 mA: ± 25 μ A at 0...500 ohm load

3.1.1 Light Spot Diameter

Working Distance	40 mm	140 mm	240 mm
Light Spot Diameter	1,5 mm	1 mm	1 mm

3.2 Warm-Up Phase

The warm-up phase typically lasts 5 minutes. After this time, the sensor delivers the specified values of the linearity deviation.



NOTICE

Specifications correspond to measured value without load. For all variants, the specification may differ due to the load on the output.

3.3 Housing Dimensions

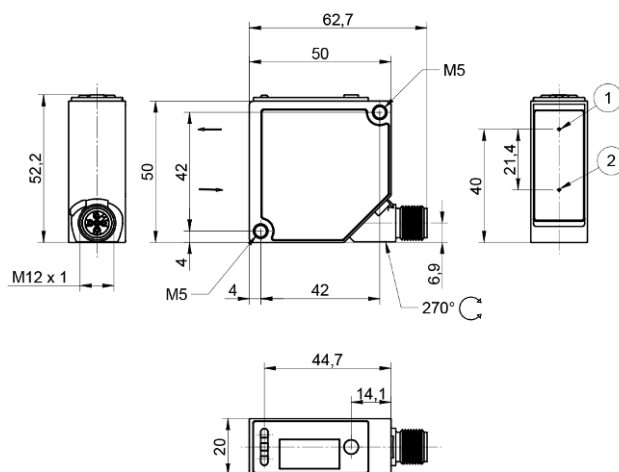

① = emitter diode

② = receiver diode

M4 screw = 1 Nm

M5 screw = 2 Nm

Dimensions in mm (1 mm = 0.03937 inch)

3.4 Control Panel

X6

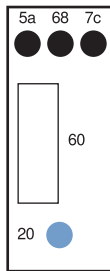

5a = switching status display, A1

7c = analog output O display

20 = enter key

60 = display

68 = power LED

3.5 Complementary Products

wenglor offers you the right connection and mounting technology as well as other accessories for your product. You can find this at www.wenglor.com on the product details page at the bottom.

3.6 Scope of delivery

- Sensor
- Safety precaution

4 Transport and Storage

4.1 Transport

Upon receipt of shipment, the goods must be inspected for damage in transit. In the case of damage, conditionally accept the package and notify the manufacturer of the damage. Then return the device, making reference to damage in transit.

4.2 Storage

The following points must be taken into consideration with regard to storage:

- Do not store the product outdoors.
- Store the product in a dry, dust-free place.
- Protect the product against mechanical impacts.
- Protect the product against exposure to direct sunlight.



NOTICE

Risk of property damage in case of improper storage!

The product may be damaged.

→ Storage instructions must be complied with.

5 Installation and Electrical Connection

5.1 Installation

- Protect the product from contamination during installation.
- Relevant electrical and mechanical regulations, standards, and safety rules must be observed.
- Protect the product from mechanical impact.
- Ensure that the sensor is mechanically secure.
- Torque values must be observed (see section Technical Data [► 9]).
- Mount the sensor using M4 screws through the mounting hole.



- Alternatively, the sensors can also be mounted with M5 screws using the thread integrated in the housing.



- Do not exceed the maximum tightening torque:
 - When using M4 screws: 1 Nm
 - When using M5 screws: 2 Nm



NOTICE

Risk of property damage in case of improper installation!

The product may be damaged!

→ Comply with installation instructions.



CAUTION

Risk of personal injury or property damage during installation!

Personal injury and damage to the product may occur.

→ Ensure a safe installation environment.

5.2 Adjustment

When adjusting sensors, note the following instructions so that the most stable object detection/measurement can be achieved:

Steps/Edges/Depressions

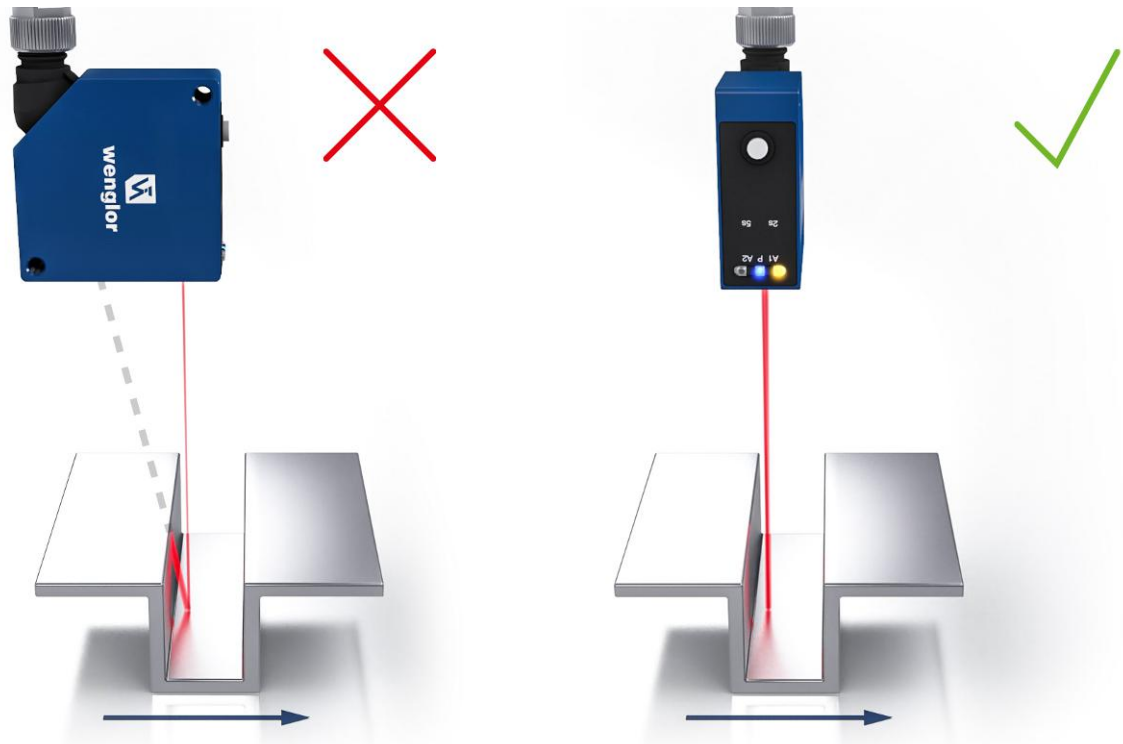

If measuring directly next to steps/edges/depressions, make sure that the receiving beam is not covered by the step/edge. The same applies when measuring the depth of gaps and holes.

With holes, blind holes and edges in the surface of moving parts, the sensor must be positioned so that the edge does not obscure the laser dot.

Round, Glossy surfaces

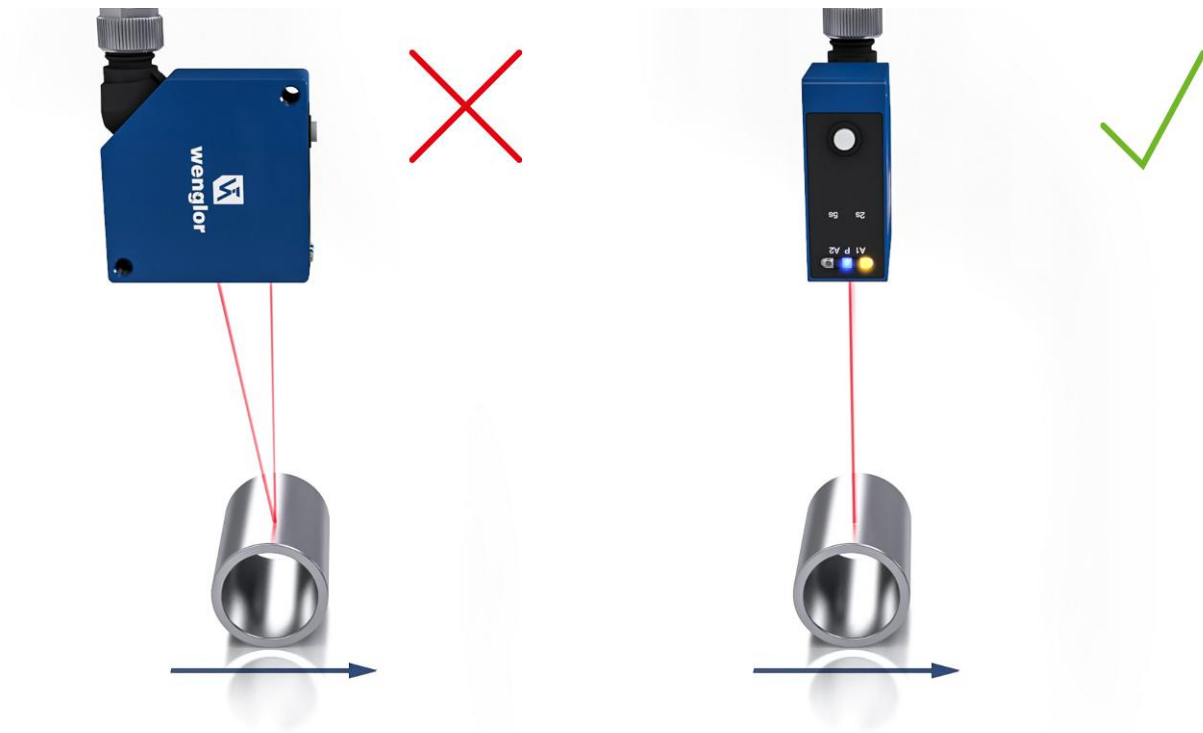

With round, glossy surfaces, the sensor should be positioned on an axis with the round object in order to avoid reflection.

Measuring Objects with Evenly Positioned, Colored Edges

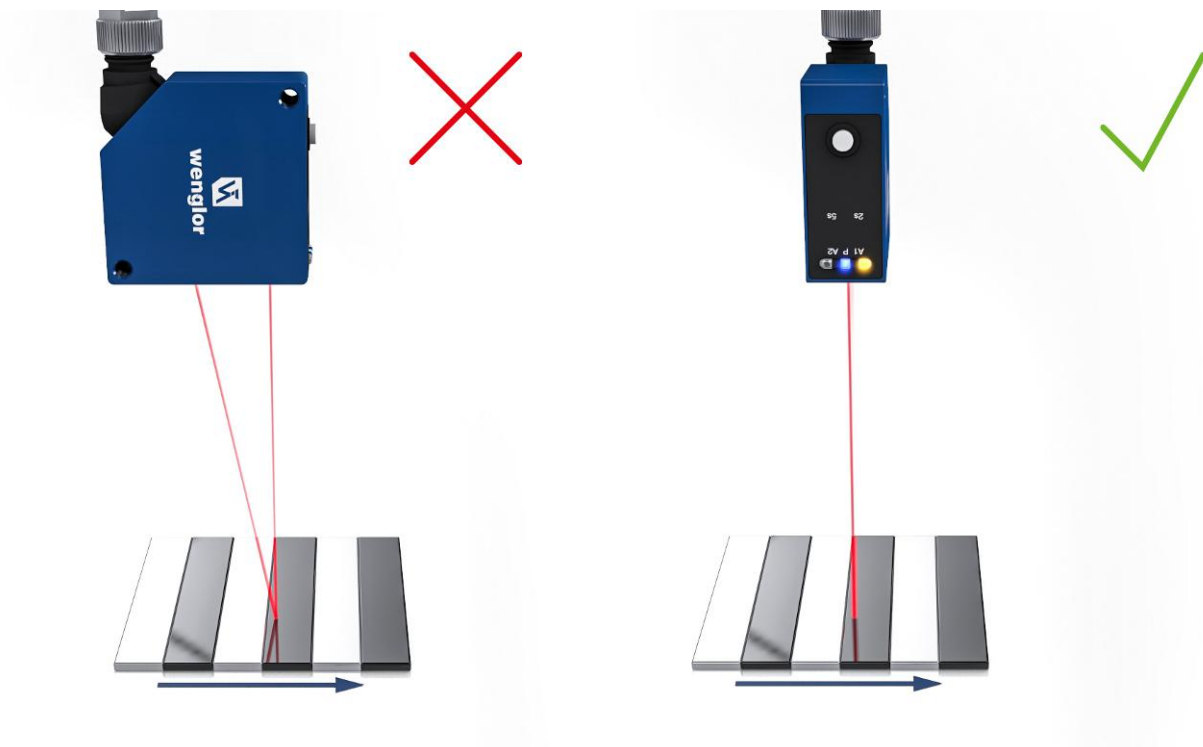

When oriented correctly, the influence on measuring accuracy is minimal. When oriented incorrectly, the different reflectivity of the various colors will result in deviations.

Moving Measuring Objects

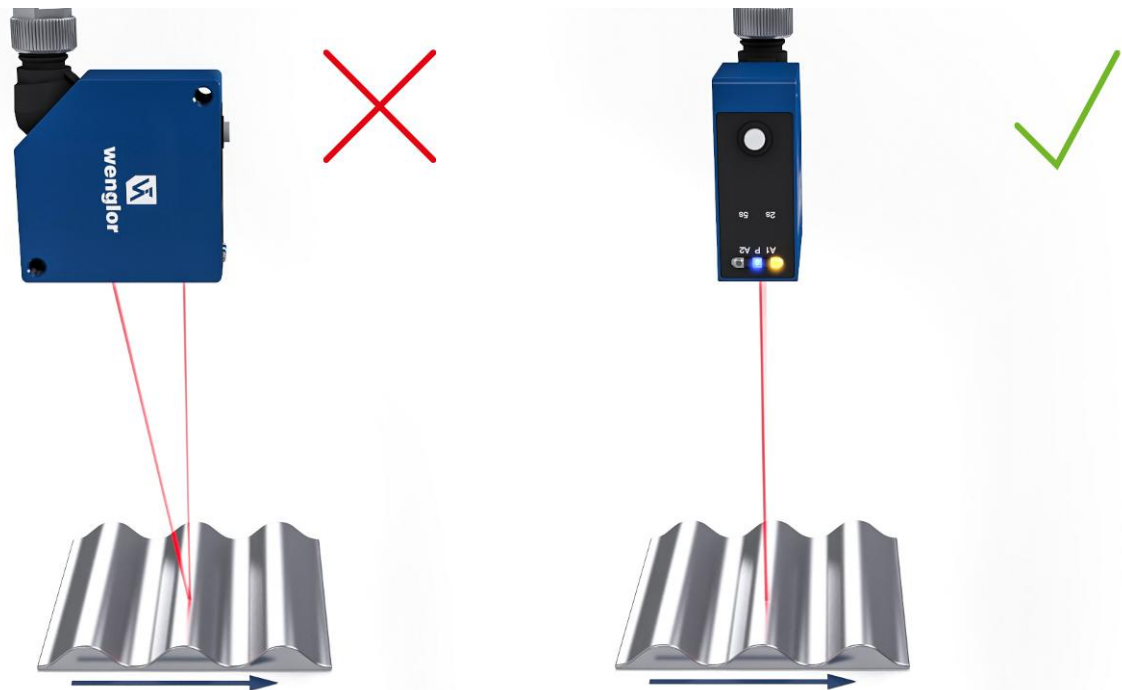

When measuring a moving object, the object must be able to move transversely to the sensor. This prevents shadows and direct reflection to the receiver.

5.3 Electrical Connection

- Wire the sensor in accordance with the connection diagram.
- Switch on the supply voltage (see section Technical Data [► 9])
- If using IO-Link, connect the sensor to 18...30 V DC.
- If not using IO-Link, connect the sensor to 10...30 V DC.
- The blue supply voltage indicator lights up.
- Adjust the sensor so that the light spot strikes the object to be detected/measured.



⚠ DANGER

Risk of personal injury or property damage due to electric current.

Voltage-conducting parts may cause personal injury or damage to equipment.

→ The electric device may be connected by appropriately qualified personnel only.

241

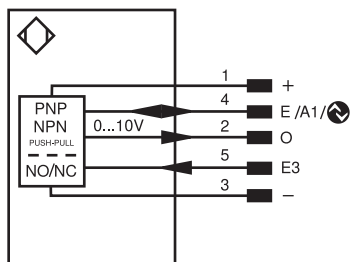



1	Brown	2	White
3	Blue	4	Black
5	Gray		

Legend					
+	Supply Voltage +	PT	Platinum measuring resistor	EN _{RS422}	Encoder A/ \bar{A} (TTL)
-	Supply Voltage 0 V	nc	Not connected	EN _{BRS422}	Encoder B/ \bar{B} (TTL)
~	Supply Voltage (AC Voltage)	U	Test Input	ENA	Encoder A
A	Switching Output (NO)	\bar{U}	Test Input inverted	EN _B	Encoder B
\bar{A}	Switching Output (NC)	W	Trigger Input	AMIN	Digital output MIN
V	Contamination/Error Output (NO)	W-	Ground for the Trigger Input	AMAX	Digital output MAX
\bar{V}	Contamination/Error Output (NC)	O	Analog Output	AOK	Digital output OK
E	Input (analog or digital)	O-	Ground for the Analog Output	SY In	Synchronization In
T	Teach Input	BZ	Block Discharge	SY OUT	Synchronization OUT
R	Reset input	AMv	Valve Output	OLT	Brightness output
Z	Time Delay (activation)	a	Valve Control Output +	M	Maintenance
S	Shielding	b	Valve Control Output 0 V	rsv	Reserved
RxD	Interface Receive Path	SY	Synchronization	Wire Colors according to DIN IEC 60757	
TxD	Interface Send Path	SY-	Ground for the Synchronization	BK	Black
RDY	Ready	E+	Receiver-Line	BN	Brown
GND	Ground	S+	Emitter-Line	RD	Red
CL	Clock	\equiv	Grounding	OG	Orange
E/A	Output/Input programmable	SnR	Switching Distance Reduction	YE	Yellow
	IO-Link	Rx+/-	Ethernet Receive Path	GN	Green
PoE	Power over Ethernet	Tx+/-	Ethernet Send Path	BU	Blue
IN	Safety Input	Bus	Interfaces-Bus A(+)/B(-)	VT	Violet
OSSD	Safety Output	La	Emitted Light disengageable	GY	Grey
Signal	Signal Output	Mag	Magnet activation	WH	White
BI_D+/-	Ethernet Gigabit bidirect. data line (A-D)	RES	Input confirmation	PK	Pink
EN _{RS422}	Encoder 0-pulse 0/ $\bar{0}$ (TTL)	EDM	Contacting Monitoring	GNYE	Green/Yellow

5.4 Diagnosis

display	Status	Meaning
Power LED P		sensor ready
		No voltage supply available
		Warning The LEDs for switching status indicator A1, A2, and analog display O remain in operation
		Error The LEDs for switching status indicator A1, A2, and analog display O are not functioning
		Localization Localization function active
		Sensor ready for Bluetooth connection
Switching status indicator A1, A2		Switching outputs active
		Switching outputs not active
Analog indicator O		Object within set measuring range
		Object outside set measuring range

- = not lit
- = permanently lit
- = flashing

5.5 Troubleshooting

Error	Possible cause	Remedy
Warning	Signal warning	<ul style="list-style-type: none"> • Reduce distance between sensor and object • Adjust angle between sensor and object • Remove contamination
	Undervoltage	<ul style="list-style-type: none"> • Increase voltage supply to at least 18 V DC
	ambient light	<ul style="list-style-type: none"> • Adjust sensor alignment to interfering light source
	Temperature too high	<ul style="list-style-type: none"> • Mount mounting bracket as cooling plate • Reduce load at the outputs
	Temperature too low	<ul style="list-style-type: none"> • Increase ambient temperature
Error	Short circuit	<ul style="list-style-type: none"> • Check the electrical wiring and eliminate the short circuit
	Temperature error	<ul style="list-style-type: none"> • Disconnect the sensor from the supply voltage and allow it to cool • Mount the mounting bracket as a heat sink • Reduce load on outputs
	Device error	<ul style="list-style-type: none"> • Disconnect the sensor from the supply voltage and restart it • Replace the sensor



INFORMATION

Behavior in case of error:

1. Shut down the machine.
2. Analyze and rectify the cause of the error using the diagnostic information.
3. If the error cannot be rectified, contact wenglor support.
4. Do not operate the machine if the error behavior is unclear.
5. The machine must be taken out of service if the error cannot be clearly identified or reliably rectified.



DANGER

Risk of personal injury or property damage if not observed!

The safety function of the system is disabled. Damage to personnel and equipment.

→ Behavior in case of error as specified.

6 Settings

The sensor can be adjusted via teach-in, IO-Link, wTeach2 and weCon. The different setting options are outlined below.

6.1 Configuration with Push of Button / Teach-In

This section describes the settings that can be configured directly on the sensor using the button. The settings can also be configured directly using the Enter key and without accessing the menu.

Analog Output

Analog Output Function

The sensor reads out its measured value as a linear proportional current or voltage value. The characteristic curve can be set within the entire measuring range.

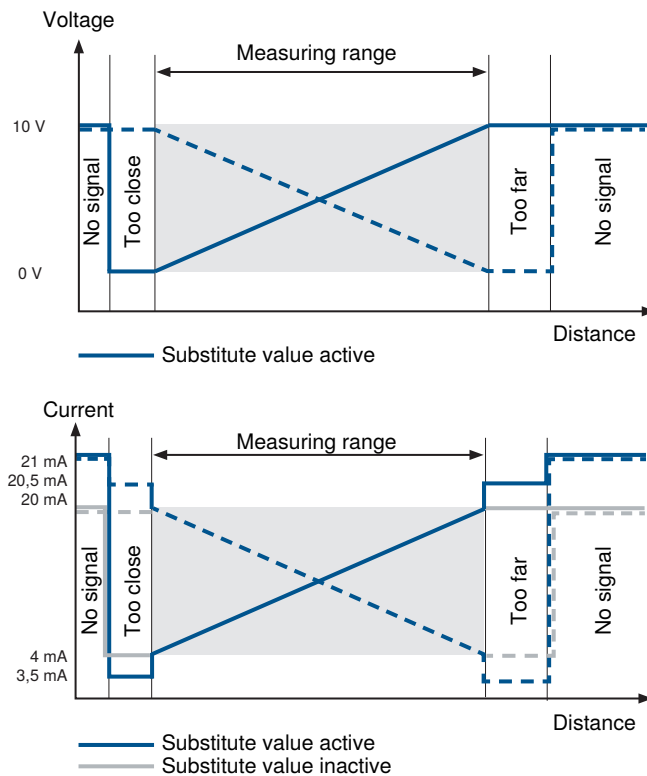

Substitute Values (Current Output Only)

By means of substitute values, the sensor is able to provide more precise diagnosis as to whether the analog signal corresponds to a valid measured value within the measuring range.

No signal: 21 mA

Rising Characteristic Curve

Object outside near measuring range: 3.5 mA

Object outside far measuring range: 20.5 mA

Falling Characteristic Curve

Object outside near measuring range: 20.5 mA

Object outside far measuring range: 3.5 mA

The Substitute Values function can be deactivated via the menu, Bluetooth, or IO-Link.

Teach-In

The teach-In function can be used to scale the analog output and assign the min./max. values to measured distances. By default, 4 mA/0 V corresponds to the minimum measuring range, and 20 mA/10 V corresponds to the maximum measuring range.

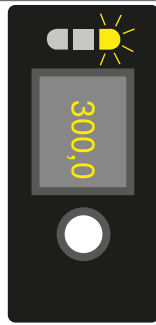

Teach-In for 4 mA/0 V

1. Adjust the sensor so that the light spot strikes the object to be measured.
2. Press and hold the Teach-in key or the Enter key for 2 seconds until O starts to flash slowly.
3. Release the Teach-in key or the Enter key.
4. The distance is taught in, and LED O flashes briefly twice in order to confirm successful teach-in.

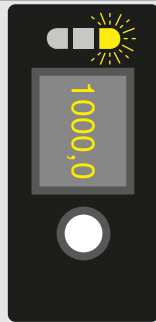

Teach-In for 20 mA/10 V

1. Adjust the sensor so that the light spot strikes the object to be measured.
2. Press and hold the Teach-in key or the Enter key for 5 seconds until LED O starts to flash rapidly.
3. Release the Teach-in key or the Enter key.
4. The distance is taught in, and LED O flashes briefly twice in order to confirm successful teach-in.



INFORMATION

Depending on whether the smaller distance value is assigned to 4 mA/0 V or 20 mA/10 V, either a rising or a falling analog characteristic curve results. If teach-in is conducted without an object or if an object is too far from the sensor, the analog value is set to the maximum value of 20 mA/10 V, and the Power LED lights up yellow. If an object that is too close is taught in, the analog value is set to the minimum value of 4 mA/0 V, and the Power LED also lights up yellow. If there is an error during teach-in preventing it from being carried out, this is indicated by a red LED.

7 Settings via menu

This section describes the settings that can be configured via the integrated OLED display. The menu is controlled by pressing the Enter button.

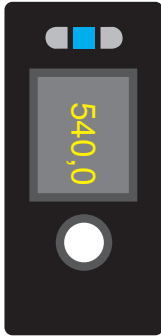

The currently measured distance is shown in display mode.

Menu control

Press the Enter button to navigate through the menu and make settings.

Short press in display mode	Jump to the menu
Short keystroke	Next menu item
Press button for 2 sec.	Selection
Press button for 5 sec.	Exit the menu, display mode



Menu structure

The menu is divided into 2 areas. Various sensor status messages are displayed in the Info menu. The Info menu is also used to open the main menu where the settings can be made.

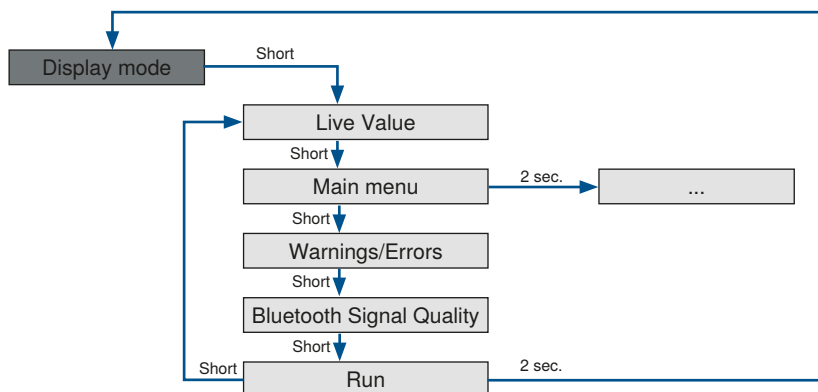
Info menu



Live value		This display is shown after jumping to the Info menu. The currently measured distance is displayed in combination with the measured value unit.
Main menu		Jump to the main menu to make settings

Warnings/Errors		Warnings or errors are displayed in this view
Bluetooth signal quality		The Bluetooth signal quality is displayed in this view.
Display mode		Jump back to the display mode

Main menu

The respective functions are described in the section Parameters [▶ 41].

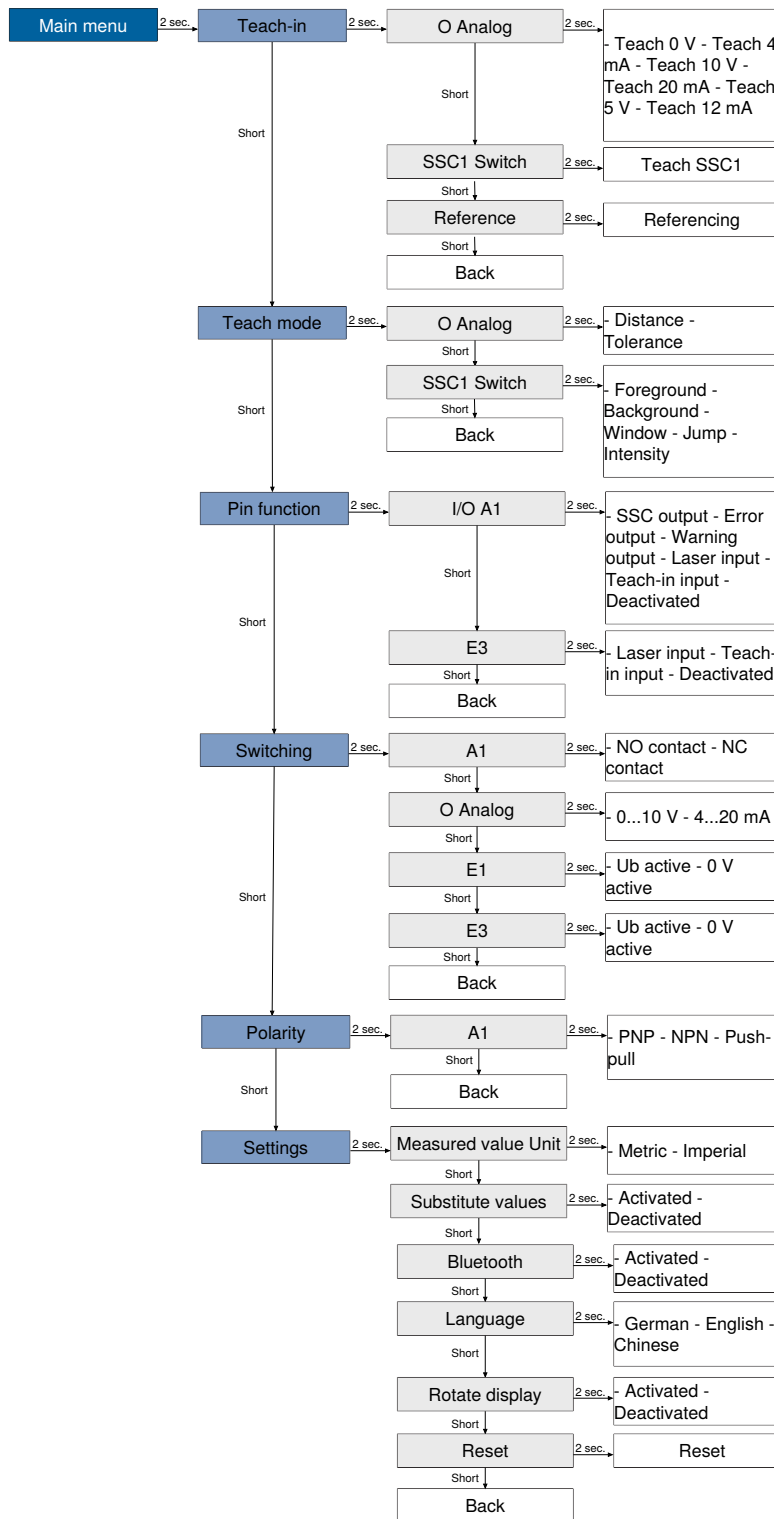

8 Function Description

The functions described in the following section can be adjusted via wTeach or IODD per IO-Link, as well as via the weCon app per Bluetooth, and the basic functions via the Display menu.

8.1 Sensor Functions

Function	Possible settings	Default
Exposure mode	<p>With black or glossy objects, it may be useful to increase the exposure time. Decreasing the exposure time can be useful if the sensor is aimed at very bright objects. The longer the exposure time, the lower the speed of the sensor.</p> <p>Auto</p> <p>With the Adaptive Autoexposure function, the sensor automatically sets its exposure time or light pulse duration to the object to be detected up to a maximum value.</p> <p>Fix</p> <p>The exposure time is set via the fixed exposure time parameter, i.e., not automatically adjusted by the sensor</p>	Auto
Fixed exposure time	<p>Used to manually set a fixed exposure time.</p> <p>1...1,600 µs</p>	1,600 µs
Maximum exposure time	<p>Maximum exposure time in Auto mode.</p> <p>1...1,600 µs</p>	1,600 µs
Measured value filter	<p>A bigger filter improves the sensor's reproducibility and smooths the signal waveform. The higher the filter number, the longer the sensor's response time when the measured values change.</p> <p>0 = OFF</p> <p>1...9</p>	3
Offset	<p>The Offset function is used to change the momentary measured value to a specified value. The switching thresholds and the analog measuring ranges are adapted along with this value. The offset value is added to the current distance.</p>	0 µm
Offset specification	<p>Value to which the current measured value is to be set by a corresponding offset. The offset is calculated automatically.</p> <p>40,000...240,000 µm</p>	0 µm
Apply offset specification	<p>The current measured value is changed to the offset specified value</p> <p>1= apply</p>	0
Distance range	<p>A distance range in which signals are to be evaluated can be defined within the working range. Signals outside the set distance range are ignored and are not included in the signal evaluation. This means that ranges for which no usable signals are expected can be completely hidden.</p> <p>This function can be used to suppress interfering signals, such as those produced by a glass disk, for instance.</p> <p>Min. distance: working range</p> <p>Max. distance: working range</p> <p>Note!</p>	Setting range

Function	Possible settings	Default
	<ul style="list-style-type: none"> Objects outside the set distance range are evaluated as “No signal”. If a distance range is set, a blind spot directly behind this range results. The sensor cannot detect any objects within the blind spot. The size of the blind spot depends on the reflectance of the interfering objects in the hidden area. 	
Sensitivity	<p>The sensor has a very high sensitivity and can detect objects, measuring the distance to them, even when the signal is very weak. In applications where the object to be detected yields even weaker signals, e.g., due to large inclinations, it can be helpful to further increase the sensitivity or to amplify the optical signal.</p> <p>The higher the sensitivity, the more susceptible the sensor is to interference. The speed of the sensor is not reduced by the setting.</p> <p>Standard Corresponds to the default setting</p> <p>High Gain by factor 2</p> <p>Maximum Gain by factor 4</p>	Standard
Emitted light	<p>The sensor’s laser can be switched on or off.</p> <p>On Laser on</p> <p>Off Laser off</p> <p>The sensor no longer supplies a measured value.</p> <p>Note!</p> <ul style="list-style-type: none"> If an input is set as a laser-off input, the emitted light can also be switched on and off via the input. If the laser is switched off, the sensor behavior corresponds to the status “No signal.” 	On
Localization	<p>The supply voltage indicator of the sensor can be switched to flashing green. This allows the sensor to be easily located in a plant.</p> <p>On The supply voltage LED flashes green.</p> <p>Off LEDs in normal function.</p>	Off
Measured value unit	<p>The measured distance can be output in micrometers or mils.</p> <p>Micrometer Distance values output in μm.</p> <p>Mil Distance values read out in mil.</p>	micrometer
Bluetooth	<p>The Bluetooth interface can be switched on/off.</p> <p>On</p> <p>Off</p>	On
Bluetooth Password Function	<p>The Bluetooth function can be password protected to prevent unauthorized access.</p> <p>On</p>	Off

Function	Possible settings	Default
	Off Note! Only the Bluetooth function is protected. Communication is possible via IO-Link or the OLED menu at any time.	
Bluetooth Password	Enter a Bluetooth password. To access the device using the Bluetooth app, enter this password in the app. Note! If the password has been forgotten, a new password can be assigned via IO-Link.	–

8.2 Display Functions

Function	Possible settings	Default
Language	Setting the menu language German English Chinese	English
Rotate display	Rotate display 180° On Off	Off

8.3 Input/Output Functions (E/A)

8.3.1 Pin Function

The pin function is used to define the function of pins E/A1 and E3, as these can be used for different functions.

Pin	Possible settings	Default
E/A1	Switching output Switching point SSC1 is assigned to the switching output. Error output The error output switches if one of the assigned errors occurs; see table Status messages [▶ 37] Warning output The warning output switches if one of the assigned warnings occurs; see table Status messages [▶ 37]. Laser-off input See E3 for an explanation Teach-in input See E3 for an explanation Deactivated The pin is deactivated.	Error output
E3	Laser-off input	Laser off Input

Pin	Possible settings	Default
	<p>The sensor's emitted light is deactivated as long as the input is activated. The sensor then does not send a measured value and sets the status to "No signal".</p> <p>Teach-In input</p> <p>Teach-in</p> <p>The outputs (switching outputs/analog output) can be set by following the same procedure as with the Teach-in key (see Configuration with Push of Button / Teach-In [▶ 19]). An activated input corresponds to a pressed Teach-in key.</p> <p>Locking</p> <p>If 18...30 V DC is continuously applied to the teach-in input, the teach-in key is locked and protected against inadvertent changes, like the input signal.</p> <p>Deactivated</p> <p>The pin is deactivated.</p>	

8.4 Output Functions

The output functions are used to set the physical outputs.

Digital Outputs

Function	Possible settings	Default
Polarity	<p>PNP</p> <p>NPN</p> <p>Push-pull</p>	PNP
Circuit	<p>NO</p> <p>Light switching (Normally Open)</p> <p>The output is high when the condition has been satisfied, depending on settings (switching point, warning, error).</p> <p>NC</p> <p>Dark switching (normally closed)</p> <p>The output is low when the condition has been fulfilled depending on the setting (switching point, warning, error).</p>	NO
On-delay	0...10,000 ms	0 ms
Off-delay	0...10,000 ms	0 ms

Analog outputs

Function	Possible settings	Default
Teach-in	Starts the teach-in process.	
Teach-in mode	<p>Distance</p> <p>A distance is taught in to the analog limit values, and the distance is output as a linearly proportional current or voltage value.</p> <div style="text-align: center;"> </div> <p>Tolerance</p>	Distance

Function	Possible settings	Default
	<p>A distance is taught in to the measuring range, serving as the measurement reference, for 5 V or 12 mA. The tolerance range is set around this value.</p>	
0 V / 4 mA	<p>In Distance teach-in mode</p> <p>In Distance teach-in mode, the 0 V or 4 mA value is assigned to a distance within the measuring range.</p> <p>Measuring range</p>	40,000 μm
10 V / 20 mA	<p>In Distance teach-in mode</p> <p>In Distance teach-in mode, the 10 V or 20 mA value is assigned to a distance within the measuring range.</p> <p>Measuring range</p>	240,000 μm
5 V / 12 mA	<p>With teach-in mode Tolerance</p> <p>In teach-in mode Tolerance, the 5 V or 12 mA value is assigned to a distance within the measuring range.</p> <p>Measuring range</p>	140,000 μm
Tolerance range	<p>For teach-in mode Tolerance</p> <p>The tolerance range is placed symmetrically around the 5 V / 12 mA point and defines the range in which the measurement takes place.</p> <p>1,000...240,000 μm</p> <p>Note!</p> <p>If the tolerance range extends beyond the limits of the measuring range, the corresponding analog values or substitute values for outside the measuring range are output from there.</p>	100,000 μm
Tolerance characteristic	<p>For teach-in mode Tolerance</p> <p>The characteristic indicates whether the analog value increases or decreases with increasing distance.</p> <p>Positive slope</p> <p>The analog value increases with increasing distance</p> <p>Negative slope</p> <p>The analog value falls with increasing distance</p>	Positive slope
Analog mode	<p>Current output</p> <p>4...20 mA</p> <p>Voltage output</p> <p>0...10 V</p>	0...10 V
Analog Replacement values	<p>The substitute values described in the section Settings – Analog output can be activated or deactivated.</p> <p>Enabled</p> <p>Sensor outputs substitute values.</p> <p>Deactivated</p>	Enabled

Function	Possible settings	Default
	Sensor does not use substitute values. Note! Function can only be used for current output.	

8.5 Input Functions

The input functions are used to set the physical inputs.

Function	Possible settings	Default
Input mode	Supply voltage active Function is triggered as soon as supply voltage is applied to the input. Supply voltage inactive Function is triggered as soon as 0 V is applied to the input or the input is opened.	Supply voltage active

8.6 Switching Point Functions (SSC1/SSC2)

The switching point functions are used to set the two switching points, SSC1 and SSC2.

SSC1 and SSC2 initially only available via IO-Link. If I/O1 is configured as a switching output, it is assigned to SSC1.

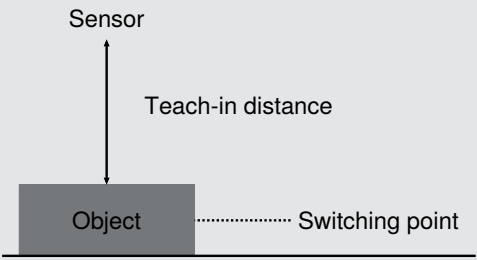
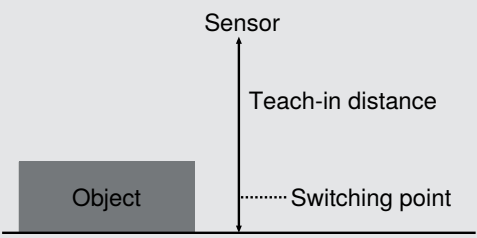
Function	Possible settings	Default
Teach-in	Starts the teach-in process.	
Teach-in mode	<p>Foreground Teach-In</p>  <p>Background Teach-In</p>  <p>Window Teach-In</p>	Foreground teach-in

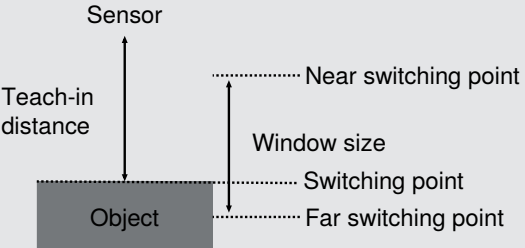
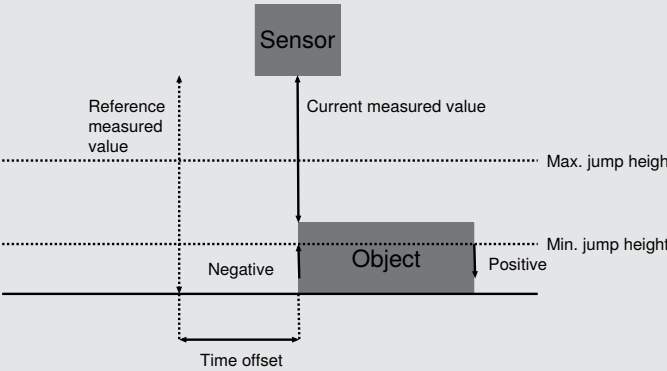
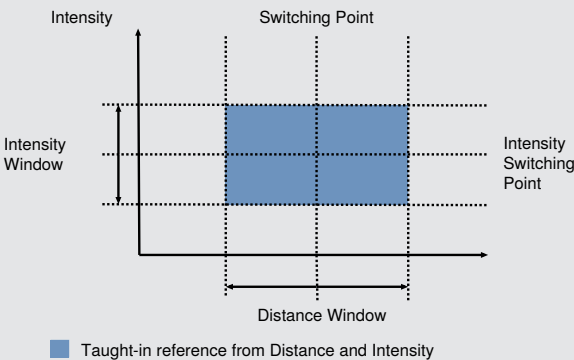
Function	Possible settings	Default
	 <p>Jump Detection</p> <p>In this mode, there is no switch to an absolute measured value, but rather to a measured value jump occurring between 2 measurements.</p>  <p>Distance and Intensity</p> <p>In this mode, the intensity of the received signal is also evaluated for distance. The sensor is taught in a reference that consists of a switching point for the distance and a switching point for the intensity. As soon as the sensor detects a deviation in distance or intensity, this is registered via the output.</p>  <p>Note!</p> <p>The teach-in function is necessary to ensure that the sensor works properly.</p>	
Switching point	40,000...240,000 μm Note If a distance range has been set, the switching point can only be set within the set distance range.	240,000 μm
Hysteresis mode	Hysteresis is the difference between the switch-on and switch-off points. Auto	Auto

Function	Possible settings	Default
	<p>The hysteresis is automatically calculated by the sensor in order to optimally adapt it to the respective situation. After a teach-in or change of the switching point, the hysteresis is recalculated and automatically updated in the hysteresis parameter. The information in the data sheet refers to the set switching point, e.g., switching point at 100 mm, hysteresis according to data sheet < 0.5% hysteresis < 0.5 mm</p> <p>Fixed</p> <p>The hysteresis is set to a fixed value in the Hysteresis parameter. This is not automatically adjusted during a teach-in or a change of the switching point. A small hysteresis is recommended for detecting flat objects against a background, while a larger hysteresis is recommended to ensure stable detection under changing conditions.</p>	
hysteresis	Absolute value of the hysteresis in hysteresis mode. Fixed 3 µm...200,000 µm	700 µm
Window switching point close	<p>In teach-in mode window teach-in</p> <p>Distance from the set window center to the switching point of the window close to the sensor.</p> <p>The window can be set so that it extends from the minimum setting range to the maximum setting range of the sensor. The minimum and maximum possible settings result from the respective set window center.</p>	30 mm
Window switching point far	<p>In teach-in mode window teach-in</p> <p>Distance from the set window center to the switching point of the window far from the sensor.</p> <p>The window can be set so that it extends from the minimum setting range to the maximum setting range of the sensor. The minimum and maximum possible settings result from the respective window center setting.</p>	30 mm
Jump height min	<p>In teach-in mode Jump detection</p> <p>The minimum jump height defines the jump in the measured value at which a jump event is to be detected.</p> <p>In the "Automatic" setting, the sensor calculates the smallest possible jump independently.</p> <p>0 = Automatic 5 µm...200,000 µm</p>	Automatic
Maximum jump height	<p>In teach-in mode, jump detection</p> <p>The max. jump height defines the maximum jump in the measured value at which a jump event is to be detected.</p> <p>In the "No restriction" setting, there is no limit to the max. jump height. A change from a valid measured value to "No measured value" is evaluated as a negative jump.</p> <p>4294967295 = No restriction 5 µm...200,000 µm</p>	no limit
Jump direction	<p>In teach-in mode, jump detection</p> <p>Positive</p> <p>A jump is detected when the measured value jumps to a higher value, i.e. the contrast value becomes brighter.</p> <p>Negative</p> <p>A jump is detected when the measured value jumps to a lower value, i.e. the contrast value becomes darker.</p> <p>Both</p>	Negative

Function	Possible settings	Default
	A jump is detected for both positive and negative.	
Cycle offset	In teach-in mode Jump detection The cycle offset specifies the time-shifted reference measured value with which the current measured value is to be compared in order to detect the jump. 1...256 Cycles	50
Jump pulse duration	In teach-in mode Jump detection 0 = hold The output remains active until the next jump in the opposite jump direction is detected. A combination with the jump direction "Both" is not permitted here. 1...10,000 ms When a jump is detected, the output is activated with the corresponding pulse length.	0
Distance Window	In teach-in mode Distance + Intensity Distance from the set switching point (center of the window) to the boundaries of the window. The distance window is symmetrical around the switching point. 3 µm...10,000 µm	700 µm
Switching point Intensity	In teach-in mode Distance + intensity Switching point of intensity in digits 1...1,000,000	30,000
Intensity window	In teach-in mode, distance + intensity from the set switching point intensity (center of the window) to the limits of the window. The intensity window is symmetrical around the switching point. 1...50%	4%

8.7 Differential and Thickness Measurement

In this operating mode, two sensors work together to calculate a difference or thickness based on the individual measurement results.

This eliminates the need for complex programming in the controller, and the system already provides a calculated value. This value can then be used for a switching function or output via an analog output. Additionally, the calculated difference or thickness is output as an absolute value via IO-Link.

Mechanical Design

differential measurement

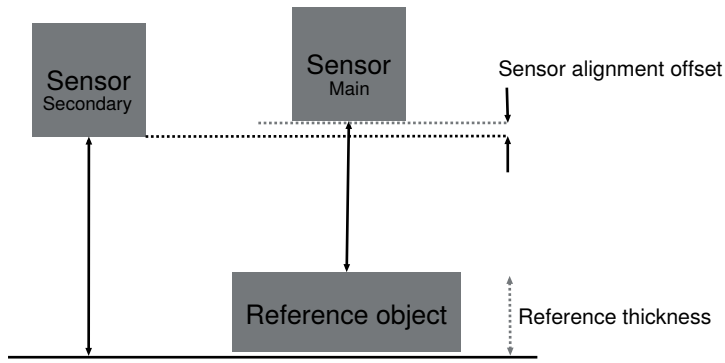

thickness measurement

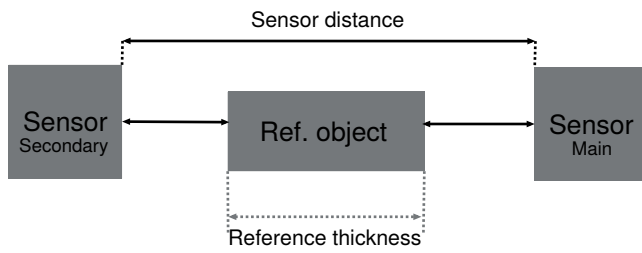

It is recommended to arrange the sensors so that no area between the sensors remains uncovered by their measuring range (Figs. 1 and 2). If this is the case, the object to be measured must be wider than the uncovered area (Fig. 3).

The sensors must be aligned so that the transmitted beams strike the front window of the opposite sensor. Care must be taken to ensure that they do not strike the emitter or receiver directly.

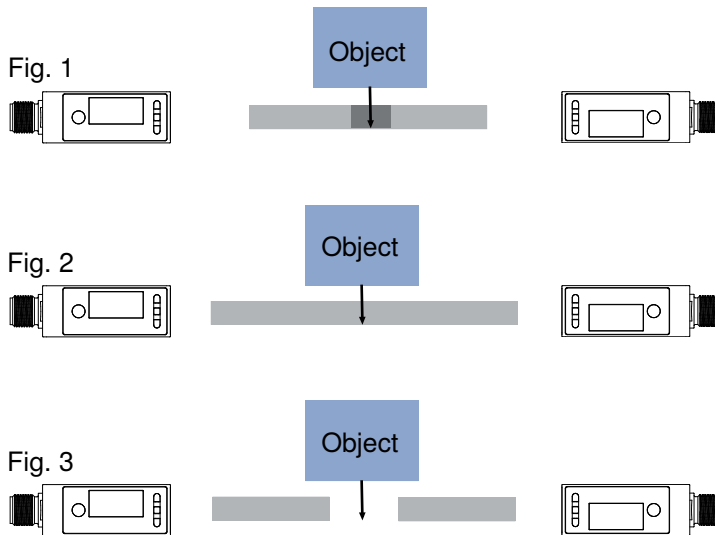

■ Working range

Wiring

With adapter

The ZC4G004 adapter can be used for easy wiring. In this case, the sensors must simply be connected as shown. The sensors are automatically parameterized for the appropriate operating modes as soon as they are connected. In this case, the main sensor is set to "thickness measurement" mode. If a differential measurement is to be performed, the mode of operation must be adjusted accordingly.

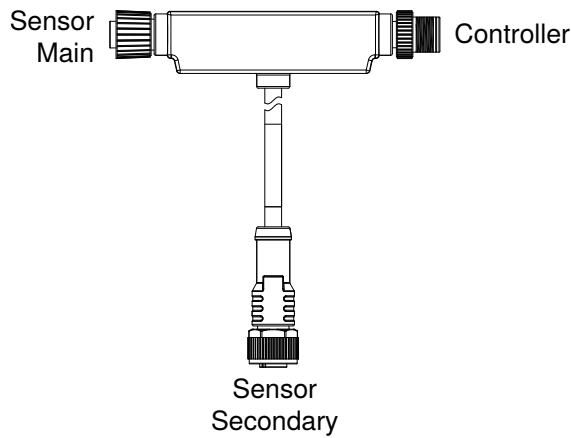

The adapter's connections can be extended using connection cables. Note that 5-pin connection cables must be used for the sensors. When connecting an IO-Link master on the control side, a 4-pin connection cable must be used.

Direct Wiring

As an alternative to using the adapter, wiring can also be done directly via terminal blocks or within a controller. To do this, connect the sensors according to the following wiring diagram. The operating modes must be set manually in each sensor.

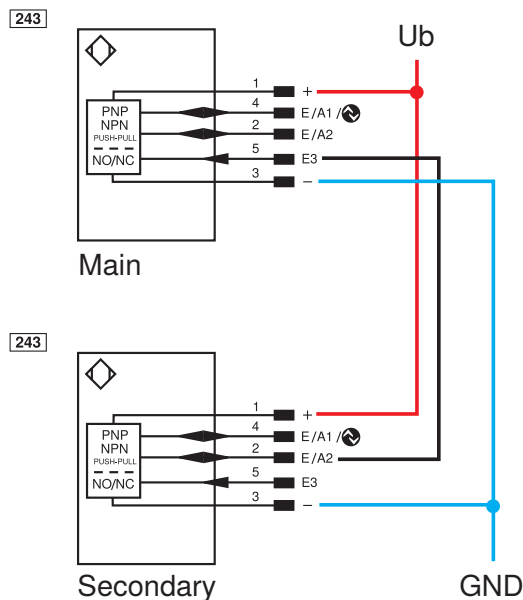

The example shows the use of 2 digital sensors. In this case, switching points can be set via pins 2 and 4 on the main sensor based on the calculated difference or thickness. Two analog sensors or a combination of digital and analog sensors can also be used. In that case, the calculated thickness can then be tapped as an analog signal at the analog output of the main sensor.



NOTICE

Sensors with different measuring ranges can also be combined. In this case, the respective working ranges must be taken into account during installation.

A combination of versions with red and blue lasers is also possible. This combination is recommended if, due to the installation situation, the sensors interfere with each other when no object is present.

Calibration

To perform thickness or differential measurements, the system must be referenced after mechanical assembly and wiring.

During this process, the sensors automatically calibrate their distances from one another so that the measurement results can be calculated according to the setup. Calibration can be performed via the teach-in key or Enter button, via the OLED menu, Bluetooth, or via IO-Link.

The reference object must be positioned in the measuring system according to the mechanical setup. For referencing via the teach-in key, hold it down for 10 seconds until the two LEDs begin to flash. Then release the key. The LEDs will flash twice briefly to confirm. The sensors are now referenced.



Outputs

If a sensor is in the Main Thickness/Difference mode of operation, the calculated thickness or difference is used for output at the outputs.

SSC1/SSC2

All settings can be configured identically to standalone operation. However, the switching points do not correspond to a distance, but rather to the thickness/difference. The switching points are set via separate parameters. All other settings are configured using the general parameters of SSC1/SSC2.

Analog output

In this operating mode, the analog output functions exclusively in tolerance mode. The reference value corresponds to 12 mA or 5 V at the analog output. The tolerance range and characteristic can be set via separate parameters.

Thickness measurement

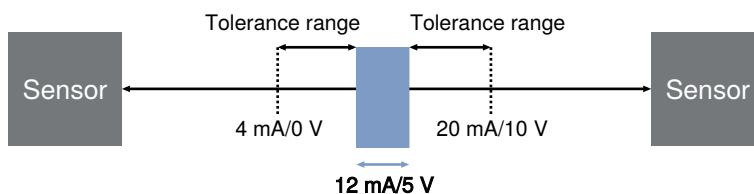

Differential measurement

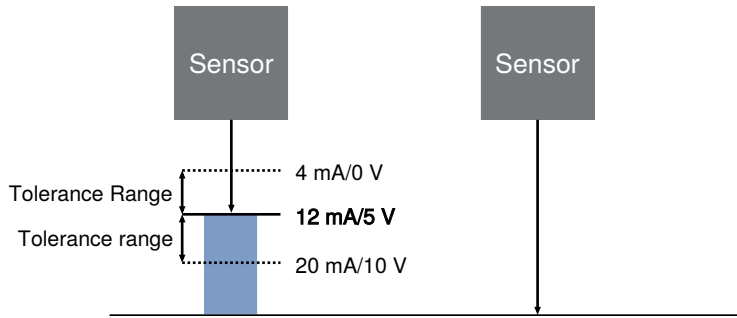

Settings

Function	Possible settings	Default
Mode of operation	<p>Stand Alone</p> <p>The device functions as a stand-alone device.</p> <p>Secondary</p> <p>The sensor provides measurement data for a main device.</p> <p>Main Thickness</p> <p>The sensor performs a thickness measurement using the connected secondary.</p> <p>Main Difference</p> <p>The sensor performs a differential measurement using the connected secondary.</p> <p>Automatic</p> <p>This setting is used to enable automatic detection of the ZC4G004 adapter, when in use, and to preset the operating mode according to the connection. The main sensor is set to Thickness mode.</p>	Automatic
Referencing	<p>Start of the referencing process</p> <p>To do so, the reference object must be placed in the measuring system, depending on the mechanical layout, and referencing started.</p> <p>With an analog sensor, 5V / 12mA is applied automatically to the analog output after referencing. Changes, in comparison to the reference thickness, are now output accordingly.</p>	
Sensor alignment offset (difference)	When referencing, the offset is calculated using the specified reference thickness.	0 μm
Sensor distance (thickness)	When referencing, the sensor distance is calculated using the specified reference thickness.	480,000 μm
Reference thickness	<p>The reference thickness corresponds to the true thickness of the reference object. This thickness is used by the sensor to calculate the absolute value that is output by the main sensor via IO-Link.</p> <p>For analog main sensors, the reference thickness is assigned the analog value 12 mA or 5 V.</p>	0 μm
Switching point	Switching point in relation to a thickness or difference used for the function of SSC1 and SSC2.	
Tolerance range	<p>The tolerance range is arranged symmetrically around the 12 mA/5 V value and defines the range by changing the analog value linearly with the measured value.</p> <p>200,000 μm</p>	1,000...200,000 μm

Function	Possible settings	Default
Tolerance characteristic	<p>Positive slope The analog value increases as the thickness increases.</p> <p>Negative slope The analog value falls as the distance increases.</p>	Positive slope

8.8 Condition Monitoring Functions

8.8.1 Status Message Function

The sensor provides various status messages. Due to the process data structure, four status messages can be transmitted as individual process data.

These parameters can be used to set the status messages that are transmitted via the process data.

Function	Possible settings	Default
Message 1	See table "Status Messages" [▶ 37]	Warning signal
Message 2	See table "Status Messages" [▶ 37]	Ambient light
Message 3	See table "Status Messages" [▶ 37]	Temperature too high
Message 4	See table "Status Messages" [▶ 37]	Short circuit

8.8.2 Warning/Error Output Function

The status messages used to trigger the collective message can be defined for the warning output and the error output respectively. The status messages are OR-linked so that the output is activated when one of the defined status messages is activated.

Function	Possible settings	Default
Warning output	See table "Status Messages"	Signal warning, optics dirty, ambient light, temperature too high, temperature too low, undervoltage, interference in the working range
Error output	See table "Status Messages"	Object too close, object too far, no signal, device error, over-temperature, short circuit

Status Messages

Warning	
Undervoltage	The supply voltage is too low.
Warning signal	The object reflects too little light.
Ambient light	Object detection is impeded by ambient light.
Overexposure	The sensor signal is overexposed.
Temperature too high	The sensor's internal temperature is high.
Temperature too low	The sensor's internal temperature is low.
Emitted light off	The sensor's emitted light is switched off.

Error	
Short circuit	A short circuit has occurred on at least one pin.
No signal	The sensor is not receiving a signal.

Error	
Object too close	The object is below the setting range or the set measuring range.
Object too far	The object is above the setting range or the set measuring range.
Temperature error	Temperature is outside permissible range. To protect the emitting unit, the emitted light is switched off.
Device error	A hardware error has occurred. For safety reasons, the emitted light is switched off.
Laser error	There is an error in the laser module. For safety reasons, the laser is switched off.

8.8.3 Simulation Functions

This function simulates the behavior of the sensor regardless of the current status and measured value. This can be used to check whether a plant in which the sensor is integrated reacts correctly to the data supplied by the sensor and processes them accordingly.

If a measured value is specified, the sensor behaves as if the specified measured value corresponds to the actual measured value. This means that the behavior of the outputs and status messages is simulated according to the specified measured value.

In addition, the individual outputs and status messages can be simulated separately from the measured value.

Function	Possible settings	Default
Simulation mode	On Off	Off
Test measured value	Current measured value min...max. measuring range	Current measured value
Output O test	According to the measured value 0...10 V	According to the measured value
SSC1 Test	According to the measured value On Off	According to measured value
SSC2 Test	According to the measured value On Off	According to measured value
Status messages test	Tests the individual status messages according to the measured value On Off	According to measured value



INFORMATION

Output A1 is used for IO-Link communication in this function and cannot be simulated.

Simulation mode ends automatically as soon as the power supply is interrupted.

9 Bluetooth

These sensors have an integrated Bluetooth interface. This interface can be used to configure and parameterize devices using a smartphone and the wenglor “weCon” app. In addition, process data is sent to the app, where it is displayed in a clear, concise manner.

9.1 weCon Installation

The wenglor app can be downloaded free of charge from the Google Play Store and Apple App Store. Download the app and follow the installation instructions.



Scan the code below to access the wenglor app directly.

9.2 Establishing Connection with Sensor

Open the weCon app on your smartphone.

When the app is opened, all wenglor sensors with Bluetooth interface and within range are set to Pairing mode.

This mode is indicated by the flashing blue LED on the sensors.

Pairing mode is used to pair the app with a corresponding sensor.

Once the app is opened, a list of all sensors within range is shown.

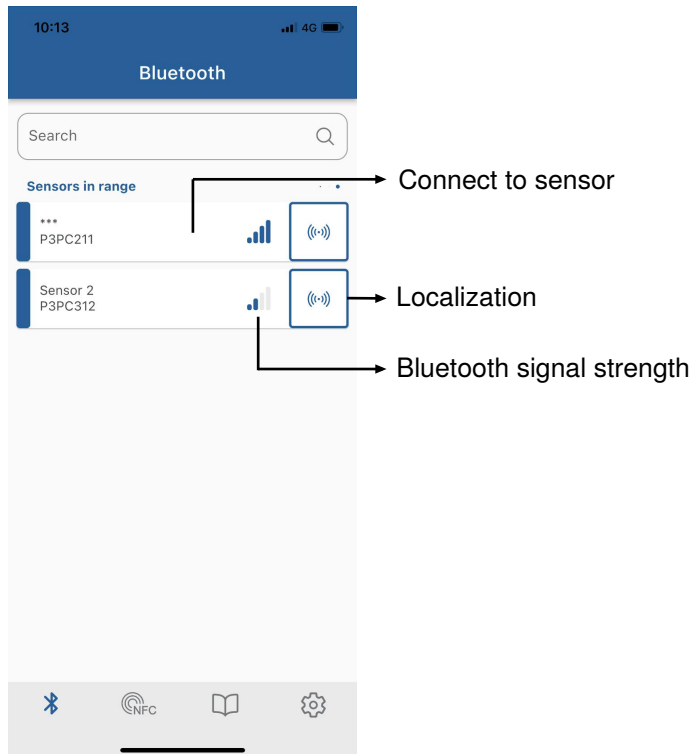

If too many sensors of the same type are fitted within the Bluetooth range, the sensor’s supply voltage LEDs can be switched to flashing green by pressing the “Localization” button. This simplifies identification.

Press the "Back" button to open the sensor list again. Pressing the "Connect with sensor" button establishes a connection to the sensor and opens the user interface.

The blue LED will continuously illuminate from now on, indicating that the sensor is paired, and Pairing mode will deactivate.

9.3 Using the weCon App

The sensor parameters are set in the "Configuration" tab. A detailed description of the individual parameters can be found in the section Function Description [▶ 24].

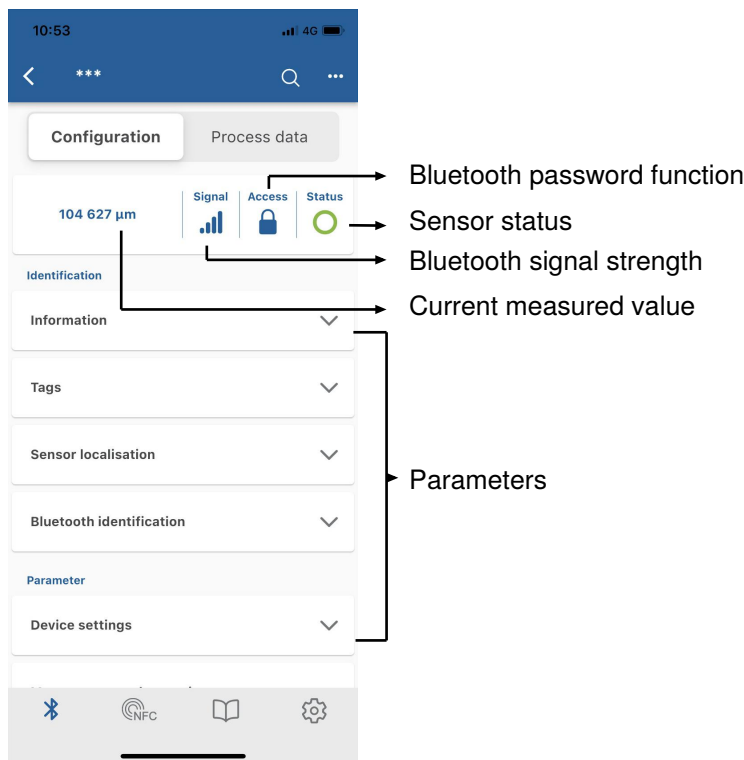

The current measured value is displayed graphically in a diagram over time in the "Process Data" tab. The scaling of the axes can be adjusted in the diagram settings.

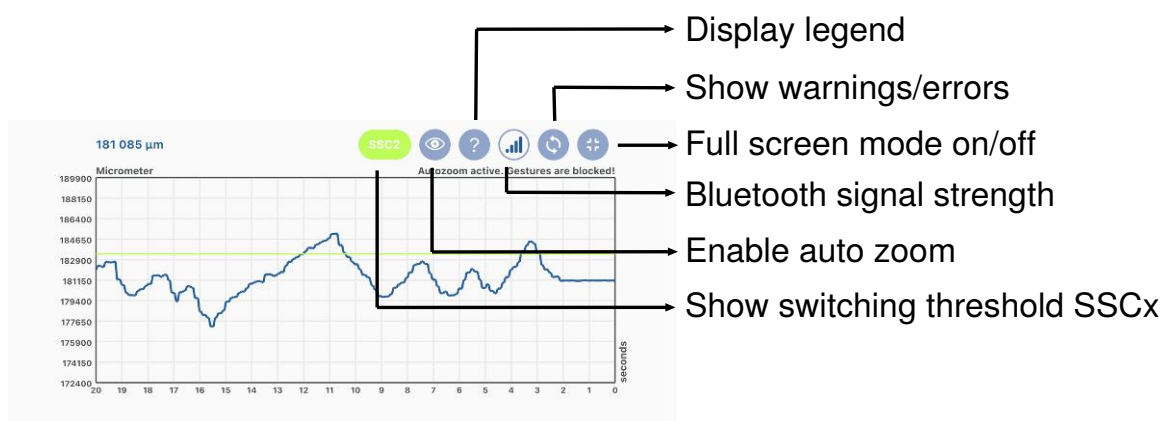

NOTICE

The Bluetooth range is approximately 10 m. If the sensor is encapsulated in a system or installed close to obstacles, the range may be reduced accordingly.

10 IO-Link

The sensors can exchange parameters and process data via IO-Link. The parameters can be used to make many additional settings on the device. The process data transmit cyclical data and condition monitoring.

To this end, the sensor is connected to a suitable IO-Link master (see product detail page/complementary products). The interface protocol and the IODD can be found at www.wenglor.com in the download area for the respective product.

10.1 Parameters

The parameters that can be configured via IO-Link are given in the functional description in the section Function description [▶ 24].

10.2 Condition Monitoring/Process Data

The data described in the following section can be read or written cyclically via IO-Link/process data.

10.2.1 Process Data In

Data	Meaning
Measured value	Measured distance in micrometers or mil. As the sensor cannot determine a measured value in the following error cases, substitute values are read out: No signal: 0x7FFFFFFC / 2147483644 Object too close: 0x80000008 / -2147483640 Object too far: 0x7FFFFFF8 / 2147483640
Scale	Scaling of the measured value to the base length unit; -6 corresponds to μm .
SSC1	Switching point 1
SSC2	Switching point 2
Warning	Collective warning in the event of one of the warning status messages (see table "Status messages") in the error output function)
Error	Collective warning in the event of one of the error status messages (see table "Status messages") in error output function.
Message 1	Status message 1 read out see Status Message Function [▶ 37]
Message 2	Status message 2 read out see Status Message Function [▶ 37]
Message 3	Status message 3 read out see Status Message Function [▶ 37]
Message 4	Status message 4 read out see Status Message Function [▶ 37]

10.2.2 Process Data Out

Data	Meaning
Emitted light	Transmit signal on/off
Localization	Sensor flashes for easy sensor location
Teach-in SSC1	Starts the teach-in process for SSC1
Teach-in SSC2	Starts the teach-in process for SSC2

10.2.3 Events

Events are diagnostic information that is standardized by IO-Link and exchanged between the IO-Link master and the device. The following events are supported:

Name	Event code	Type	Specification
Maintenance necessary: Clean	0x8C40	Notification	IO-Link
Device error – unknown error	0x1000	Error	IO-Link
Short circuit – check installation	0x7710	Error	IO-Link
Device temperature too high: Remove heat source	0x4210	Warning	IO-Link
Device temperature too low: Isolate device	0x4220	Warning	IO-Link
Temperature error: Overload	0x4000	Error	IO-Link
Supply voltage too low – check tolerances	0x5111	Warning	IO-Link

11 wTeach2 Configuration Software

For information on installing and connecting the wTeach2 software and its structure, as well as information on the general functions, see the wTeach2 operating instructions. They can be found online in the download area at www.wenglor.com under order number DNNF005.

The wTeach2 operating software can be used to configure all functions, in accordance with the function description [► 24], and read out the IO-Link process data.

In addition, there are functions that are only available via wTeach. These are described in the following sections.

11.1 Calling Up the Calibration Protocol



To access the sensor-specific calibration protocol, click on the corresponding icon in the menu bar.

Calibration Protocol

Laser Distance Sensor Triangulation

Supplier: wenglor sensoric GmbH
 Order Number: P3PC312
 Serial Number: 750126317

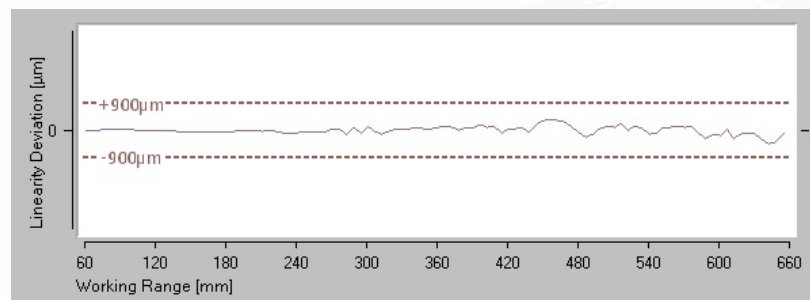

Measurement Conditions

Working Range	60 ... 660 mm
Linearity Deviation	900µm
Measured Surface	White (90%) lambertian
Filter	3 (default)
Sensor warmed up	> 5min

Differences of these Data can appear because of:

- Target material and surface
- Sensor mounting (tilt)
- Temperature fluctuation during the measurement
- Circulation of warm air between sensor and target
- Ambient light

Document was created electronically and thus valid without signature

Inspector: wenglor
 Data: 06.04.2023

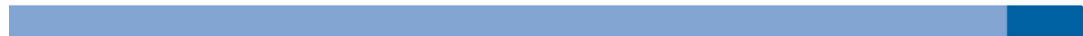

A window opens to select the location for saving the PDF document. After selection and confirmation, the document is saved accordingly.

12 Maintenance Instructions



NOTICE

This wenglor product is maintenance-free.

Cleaning and inspection of the plug connections at regular intervals are advisable.

Do not clean the product with solvents or cleaning agents that could damage the product.

The product must be protected against contamination during initial start-up.

13 Proper Disposal

wenglor sensoric GmbH does not accept the return of unusable or irreparable products. Respectively valid national waste disposal regulations apply to product disposal.

14 **Declarations of Conformity**

Declarations of conformity can be found on our website at www.wenglor.com in the product's separate download area.