

Operating Instructions

P3PC302

Laser Distance Sensor Triangulation

inspect
award 2024



EN



Table of Contents

1	General	4
1.1	Information Concerning these Instructions	4
1.2	Explanation of Symbols	4
1.3	Limitation of Liability	5
1.4	Copyrights	5
2	For Your Safety	6
2.1	Use for Intended Purpose	6
2.2	Use for Other than the Intended Purpose	6
2.3	Personnel Qualifications	6
2.4	Modification of Products	7
2.5	General Safety Precautions	7
2.6	Laser Warnings	7
2.7	Approvals and Protection Class	7
3	Technical Data	8
3.1	General Data	8
3.1.1	Light Spot Diameter	9
3.2	Warm-Up Phase	9
3.3	Housing Dimensions	9
3.4	Control Panel	10
3.5	Complementary Products	10
3.6	Scope of delivery	10
4	Transport and Storage	11
4.1	Transport	11
4.2	Storage	11
5	Installation and Electrical Connection	12
5.1	Installation	12
5.2	Adjustment	13
5.3	Electrical Connection	15
5.4	Diagnosis	16
5.5	Troubleshooting	17
6	Settings	18
6.1	Configuration with Push of Button / Teach-In	18
7	Function Description	19
7.1	Sensor Functions	19
7.2	Laser Class 2 Activation	20
7.3	Input/Output Functions (E/A)	21
7.3.1	Pin Function	21
7.4	Output Functions	22
7.5	Input Functions	23
7.6	Switching Point Functions (SSC1/SSC2)	23
7.7	Differential and Thickness Measurement	26
7.8	Condition Monitoring Functions	30
7.8.1	Status Message Function	30
7.8.2	Warning/Error Output Function	30

7.8.3	Simulation Functions	31
8	IO-Link	32
8.1	Parameters.....	32
8.2	Condition Monitoring/Process Data.....	32
8.2.1	Process Data In.....	32
8.2.2	Process Data Out.....	32
8.2.3	Events.....	32
9	wTeach2 Configuration Software.....	34
9.1	Laser Class 2 Licensing	34
9.2	Calling Up the Calibration Protocol.....	35
10	Maintenance Instructions	36
11	Proper Disposal	37
12	Declarations of Conformity.....	38

1 General

1.1 Information Concerning these Instructions

- These instructions make it possible to use the product safely and efficiently.
- These instructions are an integral part of the product and must be kept on hand for the entire duration of its service life.
- Local accident prevention regulations and national work safety regulations must be complied with as well.
- The product is subject to further technical development, and thus the information contained in these operating instructions may also be subject to change. The current version can be found at www.wenglor.com in the product's separate download area.



INFORMATION

The operating instructions must be read carefully before using the product and must be kept on hand for later reference.

1.2 Explanation of Symbols

- Safety precautions and warnings are emphasized by means of symbols and signal words.
- Safe use of the product is only possible if these safety precautions and warnings are adhered to.

The safety precautions and warnings are laid out in accordance with the following principle:

SIGNAL WORD

Type and source of danger!

Possible consequences in the event that the hazard is disregarded.

→ Measures for averting the hazard.

The meanings of the signal words, as well as the scope of the associated hazards, are listed below:



DANGER

This signal word indicates a hazard with a high degree of risk which, if not avoided, results in death or severe injury.



WARNING

This signal word indicates a hazard with a medium degree of risk which, if not avoided, may result in death or severe injury.



CAUTION

This signal word indicates a hazard with a low degree of risk which, if not avoided, may result in minor or moderate injury.



NOTICE

This signal word draws attention to a potentially hazardous situation which, if not avoided, may result in property damage.



INFORMATION

Information draws attention to useful tips and suggestions, as well as information on efficient, error-free use.

1.3 Limitation of Liability

- The product has been developed in consideration of the current state-of-the-art technology, as well as applicable standards and guidelines. Subject to change without notice.
- A valid declaration of conformity can be accessed at www.wenglor.com in the product's separate download area.
- wenglor sensoric elektronische Geräte GmbH (hereinafter referred to as "wenglor") excludes all liability in the event of:
 - Non-compliance with the instructions
 - Use of the product for purposes other than those intended.
 - Use by untrained personnel.
 - Use of unapproved spare parts.
 - Unapproved modification of products.
- These operating instructions do not include any guarantees from wenglor with regard to the described procedures or specific product characteristics.
- wenglor assumes no liability for printing errors or other inaccuracies contained in these operating instructions unless wenglor was verifiably aware of such errors at the point in time at which the operating instructions were prepared.

1.4 Copyrights

- The contents of these instructions are protected by copyright law.
- All rights are reserved by wenglor.
- Commercial reproduction or any other commercial use of the provided content and information, in particular graphics and images, is not permitted without previous written consent from wenglor.

2 For Your Safety

2.1 Use for Intended Purpose

Laser Distance Sensors Triangulation

Triangulation laser distance sensors work according to the principle of angle measurement, where the object's color, shape, and surface do not affect the measurement. Depending on the setting, they can be operated at very high speed or resolution. The measuring range can be selected individually within the sensor's working range.

This Product Can Be Used in the Following Industry Sectors:

- Special-purpose mechanical engineering
- Heavy mechanical engineering
- Logistics
- Automotive industry
- Food industry
- Packaging industry
- Pharmaceuticals industry
- Plastics industry
- Woodworking industry
- Consumer goods industry
- Paper industry
- Electronics industry
- Glass industry
- Steel industry
- Aviation industry
- Chemicals industry
- Alternative energies
- Raw materials extraction

2.2 Use for Other than the Intended Purpose

- Not a safety component in accordance with 2006/42/EC (Machinery Directive).
- The product is not suitable for use in potentially explosive atmospheres.
- The product may be used only with accessories supplied or approved by wenglor, or in combination with approved products. A list of approved accessories and combination products can be found at www.wenglor.com on the product detail page.



DANGER

Risk of personal injury or property damage in case of use for other than the intended purpose!

Use for other than the intended purpose may lead to hazardous situations.

→ Observe instructions regarding use for intended purpose.

2.3 Personnel Qualifications

- Suitable technical training is a prerequisite.
- In-house electronics training is required.
- Trained personnel who use the product must have (permanent) access to the operating instructions.



DANGER

Risk of personal injury or property damage in case of incorrect initial start-up and maintenance!

Personal injury and damage to equipment may occur.

→ Adequate training and qualification of personnel

2.4 Modification of Products



DANGER

Risk of personal injury or property damage if the product is modified!

Personal injury and damage to equipment may occur. Noncompliance may result in loss of the CE and/or UKCA mark and voiding of the warranty.

→ Modification of the product is not permitted

2.5 General Safety Precautions



INFORMATION

These instructions are an integral part of the product and must be kept on hand for the entire duration of its service life.

In the event of possible changes, the current version of the operating instructions can be found at www.wenglor.com in the product's separate download area.

Read the operating instructions carefully before using the product.

Protect the sensor against contamination and mechanical influences.

2.6 Laser Warnings



Laser Class 1 (EN 60825-1)

Applicable standards and safety regulations must be observed.

Complies with 21 CFR 1040.10 and 1040.11 except for conformance with IEC 60825-1 Ed. 3., as described in Laser Notice No. 56, dated May 8, 2019.

2.7 Approvals and Protection Class

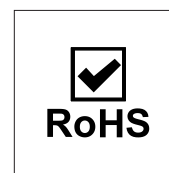
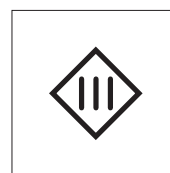
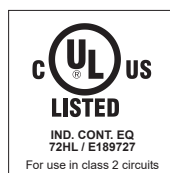

3 Technical Data

3.1 General Data

Technical Data	
Optical Data	
Working Range	60 ... 660 mm
Setting Range	60 ... 660 mm
Reproducibility maximum	550 µm
Reproducibility: 1 Sigma	30 µm
Linearity Deviation	900 µm
Switching Hysteresis	< 0.5 %
Light Source	Laser (red)
Wavelength	655 nm
Service Life (T = +25 °C)	100000 h
Laser Class (EN 60825-1)	1
Max. Ambient Light	20000 Lux
Light Spot Diameter	See section Light Spot Diameter [► 9]
Electrical Data	
Supply Voltage	18 ... 30 V DC
Current Consumption (U _b = 24 V)	< 50 mA
Switching Frequency	650 Hz
Response Time	< 0.5 ms
Temperature Drift	< 50 µm/K
Temperature Range	-30 ... 60 °C
Number of Switching Outputs	2
Switching Output Voltage Drop	< 1.5 V
Switching Output/Switching Current	100 mA
Short Circuit and Overload Protection	yes
Reverse Polarity Protection	yes
Interface	IO-Link V1.1
Baud Rate	COM3
Protection Class	III
FDA Accession Number	2310674-000
Mechanical Data	
Setting Method	Teach-In
Housing Material	Aluminum, anodised Plastic, ABS
Optic Cover	Plastic, PMMA
Degree of Protection	IP67
Connection	M12 × 1; 4/5-pin
Output Functions	
Output	NPN NO
Technical Safety Data	
MTTFd (EN ISO 13849-1)	720.35 a

3.1.1 Light Spot Diameter

Working Distance	60 mm	360 mm	660 mm
Light Spot Diameter	1,5 mm	1 mm	0,5 mm

3.2 Warm-Up Phase

The warm-up phase typically lasts 5 minutes. After this time, the sensor delivers the specified values of the linearity deviation.



NOTICE

Specifications correspond to measured value without load. For all variants, the specification may differ due to the load on the output.

3.3 Housing Dimensions

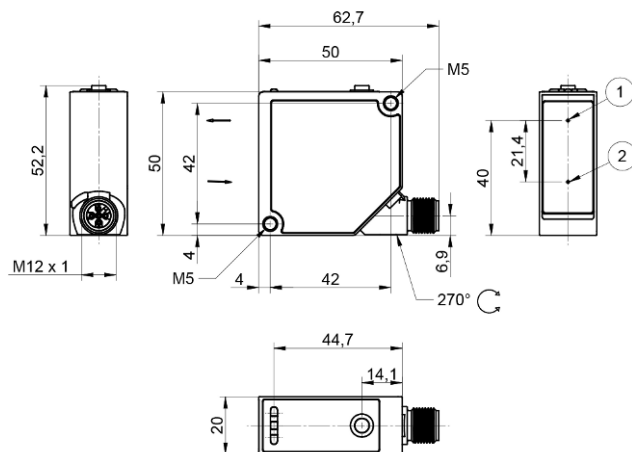

① = emitter diode

② = receiver diode

M4 screw = 1 Nm

M5 screw = 2 Nm

Dimensions in mm (1 mm = 0.03937 inch)

3.4 Control Panel

X5



5a = switching status indicator A1

06 = teach-in key

6a = switching status indicator A2

68 = power LED

3.5 Complementary Products

wenglor offers you the right connection and mounting technology as well as other accessories for your product. You can find this at www.wenglor.com on the product details page at the bottom.

3.6 Scope of delivery

- Sensor
- Safety precaution

4 Transport and Storage

4.1 Transport

Upon receipt of shipment, the goods must be inspected for damage in transit. In the case of damage, conditionally accept the package and notify the manufacturer of the damage. Then return the device, making reference to damage in transit.

4.2 Storage

The following points must be taken into consideration with regard to storage:

- Do not store the product outdoors.
- Store the product in a dry, dust-free place.
- Protect the product against mechanical impacts.
- Protect the product against exposure to direct sunlight.



NOTICE

Risk of property damage in case of improper storage!

The product may be damaged.

→ Storage instructions must be complied with.

5 Installation and Electrical Connection

5.1 Installation

- Protect the product from contamination during installation.
- Relevant electrical and mechanical regulations, standards, and safety rules must be observed.
- Protect the product from mechanical impact.
- Ensure that the sensor is mechanically secure.
- Torque values must be observed (see section Technical Data [► 8]).
- Mount the sensor using M4 screws through the mounting hole.



- Alternatively, the sensors can also be mounted with M5 screws using the thread integrated in the housing.



- Do not exceed the maximum tightening torque:
 - When using M4 screws: 1 Nm
 - When using M5 screws: 2 Nm



NOTICE

Risk of property damage in case of improper installation!

The product may be damaged!

→ Comply with installation instructions.



CAUTION

Risk of personal injury or property damage during installation!

Personal injury and damage to the product may occur.

→ Ensure a safe installation environment.

5.2 Adjustment

When adjusting sensors, note the following instructions so that the most stable object detection/measurement can be achieved:

Steps/Edges/Depressions

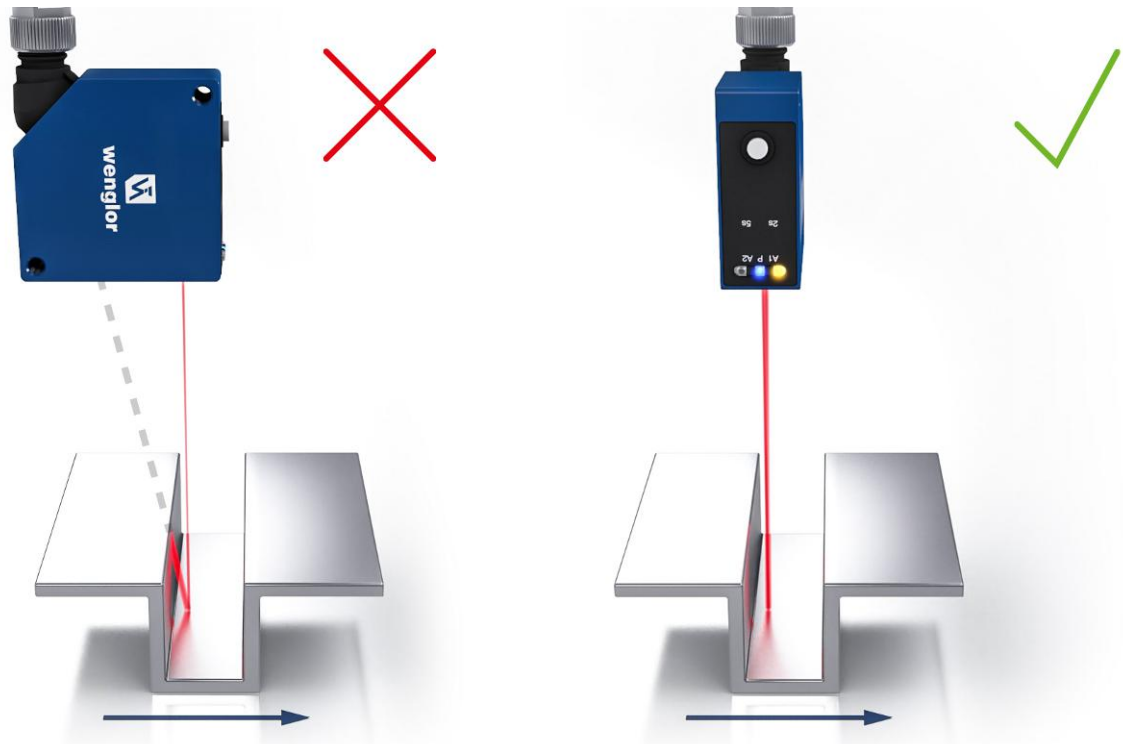

If measuring directly next to steps/edges/depressions, make sure that the receiving beam is not covered by the step/edge. The same applies when measuring the depth of gaps and holes.

With holes, blind holes and edges in the surface of moving parts, the sensor must be positioned so that the edge does not obscure the laser dot.

Round, Glossy surfaces

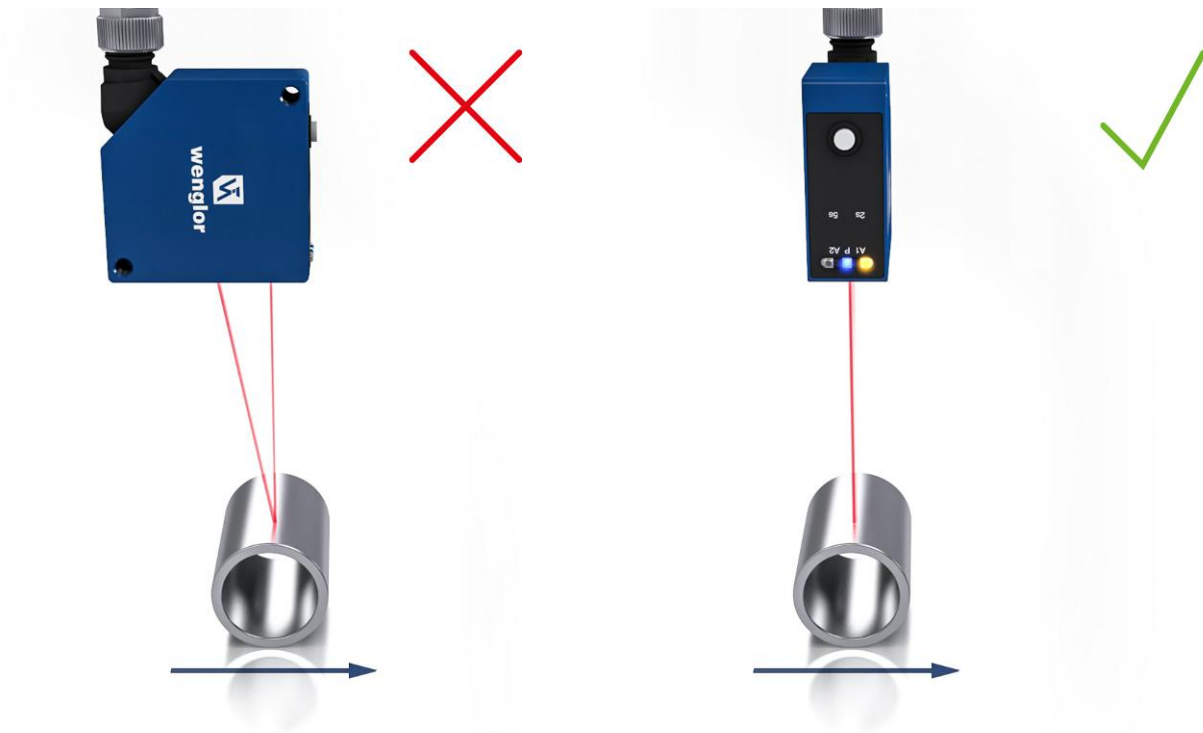

With round, glossy surfaces, the sensor should be positioned on an axis with the round object in order to avoid reflection.

Measuring Objects with Evenly Positioned, Colored Edges

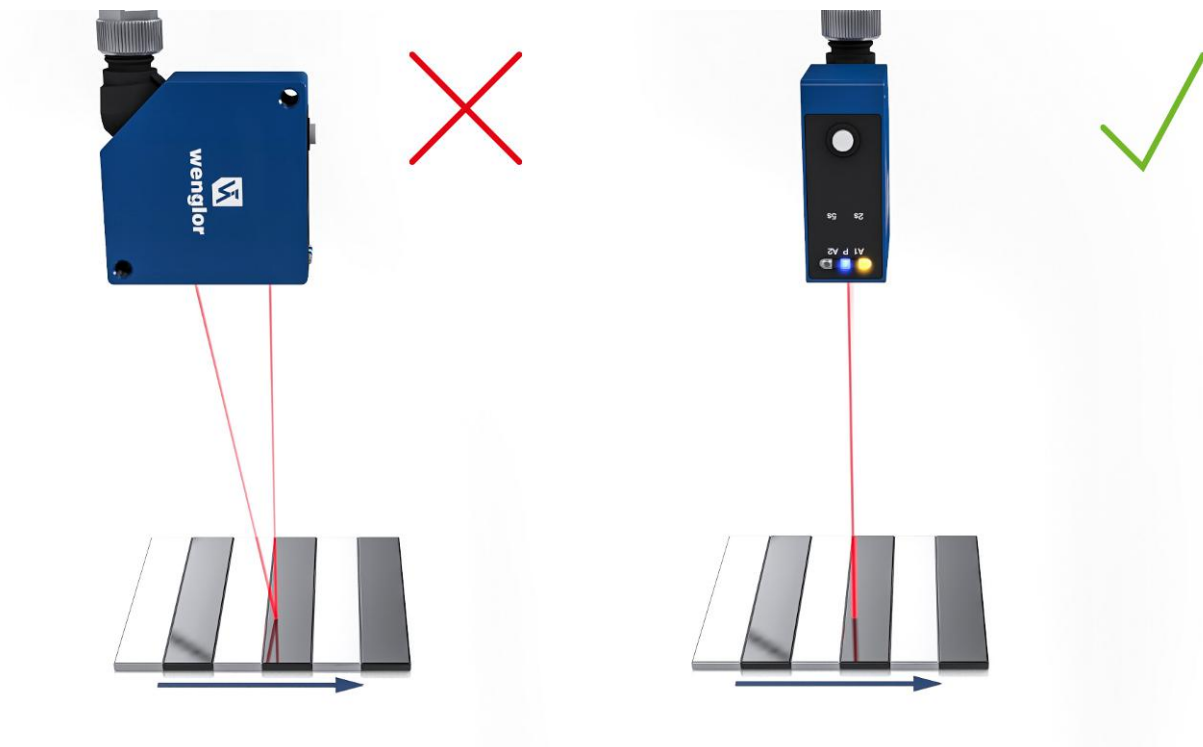

When oriented correctly, the influence on measuring accuracy is minimal. When oriented incorrectly, the different reflectivity of the various colors will result in deviations.

Moving Measuring Objects

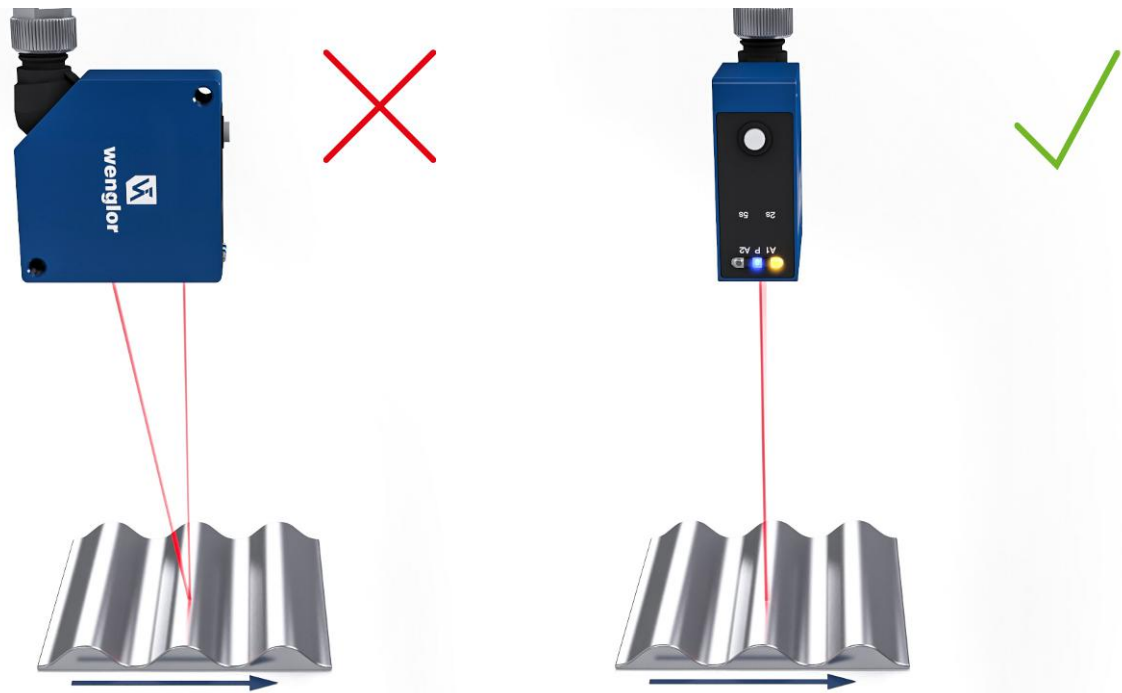

When measuring a moving object, the object must be able to move transversely to the sensor. This prevents shadows and direct reflection to the receiver.

5.3 Electrical Connection

- Wire the sensor in accordance with the connection diagram.
- Switch on the supply voltage (see section Technical Data [► 8])
- If using IO-Link, connect the sensor to 18...30 V DC.
- If not using IO-Link, connect the sensor to 10...30 V DC.
- The blue supply voltage indicator lights up.
- Adjust the sensor so that the light spot strikes the object to be detected/measured.



DANGER

Risk of personal injury or property damage due to electric current.

Voltage-conducting parts may cause personal injury or damage to equipment.

→ The electric device may be connected by appropriately qualified personnel only.

243

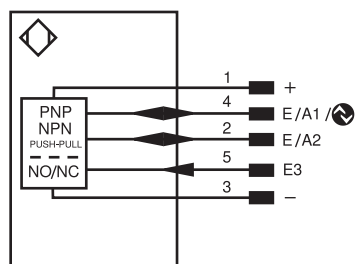

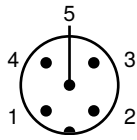

1	Brown	2	White
3	Blue	4	Black
5	Gray		

Legend					
+	Supply Voltage +	PT	Platinum measuring resistor	EN _A RS422	Encoder A/Ā (TTL)
-	Supply Voltage 0 V	nc	Not connected	EN _B RS422	Encoder B/B̄ (TTL)
~	Supply Voltage (AC Voltage)	U	Test Input	ENA	Encoder A
A	Switching Output (NO)	Ū	Test Input inverted	EN _B	Encoder B
Ā	Switching Output (NC)	W	Trigger Input	AMIN	Digital output MIN
V	Contamination/Error Output (NO)	W-	Ground for the Trigger Input	AMAX	Digital output MAX
V̄	Contamination/Error Output (NC)	O	Analog Output	AOK	Digital output OK
E	Input (analog or digital)	O-	Ground for the Analog Output	SY In	Synchronization In
T	Teach Input	BZ	Block Discharge	SY OUT	Synchronization OUT
R	Reset input	AMv	Valve Output	OLT	Brightness output
Z	Time Delay (activation)	a	Valve Control Output +	M	Maintenance
S	Shielding	b	Valve Control Output 0 V	rsv	Reserved
RxD	Interface Receive Path	SY	Synchronization	Wire Colors according to DIN IEC 60757	
TxD	Interface Send Path	SY-	Ground for the Synchronization	BK	Black
RDY	Ready	E+	Receiver-Line	BN	Brown
GND	Ground	S+	Emitter-Line	RD	Red
CL	Clock	⊕	Grounding	OG	Orange
E/A	Output/Input programmable	SnR	Switching Distance Reduction	YE	Yellow
	IO-Link	Rx+/-	Ethernet Receive Path	GN	Green
PoE	Power over Ethernet	Tx+/-	Ethernet Send Path	BU	Blue
IN	Safety Input	Bus	Interfaces-Bus A(+)/B(-)	VT	Violet
OSSD	Safety Output	La	Emitted Light disengageable	GY	Grey
Signal	Signal Output	Mag	Magnet activation	WH	White
BI_D+/-	Ethernet Gigabit bidirect. data line (A-D)	RES	Input confirmation	PK	Pink
EN ₀ RS422	Encoder 0-pulse 0/0̄ (TTL)	EDM	Contacting Monitoring	GNYE	Green/Yellow

5.4 Diagnosis

display	Status	Meaning
Power LED P		Sensor ready
		No voltage supply available
		Warning The LEDs for switching status indicator A1, A2, and analog display O remain in operation
		Error The LEDs for switching status indicator A1, A2, and analog display O are not functioning
		Localization Localization function active
Switching status indicator A1, A2		Switching outputs active
		Switching outputs not active

- = not lit
- = permanently lit
- = flashing

5.5 Troubleshooting

Error	Possible cause	Remedy
Warning	Signal warning	<ul style="list-style-type: none"> • Reduce distance between sensor and object • Adjust angle between sensor and object • Remove contamination
	Undervoltage	<ul style="list-style-type: none"> • Increase voltage supply to at least 18 V DC
	ambient light	<ul style="list-style-type: none"> • Adjust sensor alignment to interfering light source
	Temperature too high	<ul style="list-style-type: none"> • Mount mounting bracket as cooling plate • Reduce load at the outputs
	Temperature too low	<ul style="list-style-type: none"> • Increase ambient temperature
Error	Short circuit	<ul style="list-style-type: none"> • Check the electrical wiring and eliminate the short circuit
	Temperature error	<ul style="list-style-type: none"> • Disconnect the sensor from the supply voltage and allow it to cool • Mount the mounting bracket as a heat sink • Reduce load on outputs
	Device error	<ul style="list-style-type: none"> • Disconnect the sensor from the supply voltage and restart it • Replace the sensor



INFORMATION

Behavior in case of error:

1. Shut down the machine.
2. Analyze and rectify the cause of the error using the diagnostic information.
3. If the error cannot be rectified, contact wenglor support.
4. Do not operate the machine if the error behavior is unclear.
5. The machine must be taken out of service if the error cannot be clearly identified or reliably rectified.



DANGER

Risk of personal injury or property damage if not observed!

The safety function of the system is disabled. Damage to personnel and equipment.

→ Behavior in case of error as specified.

6 Settings

The sensor can be set via teach-in, IO-Link and wTeach2. The different setting options are outlined below.

6.1 Configuration with Push of Button / Teach-In

This section describes the settings that can be configured directly on the sensor using the button.

switching output

teach-in

Various teach-in modes are available. These can be set via IO-Link (see section Parameters [▶ 32]). The default setting is foreground teach-in.

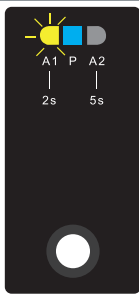

teach-in for A1

1. Adjust the sensor so that the light spot strikes the object to be taught in.
2. Press and hold the teach-in key or enter button for 2 seconds until LED A1 starts flashing.
3. Release the teach-in key or Enter button.
4. The distance is taught in and the LED A1 flashes twice briefly to confirm successful teaching.

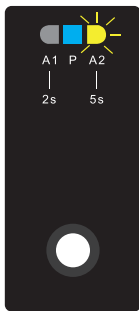

teach-in for A2

1. Adjust the sensor so that the light spot strikes the object to be taught in.
2. Press and hold the teach-in key or enter button for 5 seconds until LED A2 starts flashing.
3. Release the teach-in key or Enter button.
4. The distance is taught in and the LED A2 flashes twice briefly to confirm that the teaching-in was successful.



INFORMATION

When teaching in, if there is no object or the object is too far from the sensor, the switching distance is set to the end of the setting range. The Power LED lights up yellow, and the switching status LEDs for the respective switching output flash twice. The same applies to an object that is too close; here, the switching distance is set to the start of the setting range. If there is an error during teach-in preventing it from being carried out, this is indicated by a red LED.

7 Function Description

The functions described in the following section can be set via wTeach or IODD via IO-Link.

7.1 Sensor Functions

Function	Possible settings	Default
Exposure mode	<p>With black or glossy objects, it may be useful to increase the exposure time. Decreasing the exposure time can be useful if the sensor is aimed at very bright objects. The longer the exposure time, the lower the speed of the sensor.</p> <p>Auto</p> <p>With the Adaptive Autoexposure function, the sensor automatically sets its exposure time or light pulse duration to the object to be detected up to a maximum value.</p> <p>Fix</p> <p>The exposure time is set via the fixed exposure time parameter, i.e., not automatically adjusted by the sensor</p>	Auto
Fixed Exposure time	<p>Manual setting of a fixed exposure time</p> <p>1...1600 µs</p>	400 µs
Maximum exposure time	<p>Maximum exposure time in Auto mode.</p> <p>1...1600 µs</p>	400 µs
Measured value filter	<p>A bigger filter improves the sensor's reproducibility and smooths the signal waveform. The higher the filter number, the longer the sensor's response time when the measured values change.</p> <p>0 = OFF</p> <p>1...9</p>	3
Offset	<p>The Offset function is used to change the momentary measured value to a specified value. The switching thresholds and the analog measuring ranges are adapted along with this value. The offset value is added to the current distance.</p>	0 µm
Offset specification	<p>Value to which the current measured value is to be set by a corresponding offset. The offset is calculated automatically.</p> <p>60,000...660,000 µm</p>	0 µm
Apply offset specification	<p>The current measured value is changed to the offset specified value</p> <p>1= apply</p>	0
Distance range	<p>A distance range in which signals are to be evaluated can be defined within the working range. Signals outside the set distance range are ignored and are not included in the signal evaluation. This means that ranges for which no usable signals are expected can be completely hidden.</p> <p>This function can be used to suppress interfering signals, such as those produced by a glass disk, for instance.</p> <p>Min. distance: working range</p> <p>Max. distance: working range</p> <p>Note!</p>	Setting range

Function	Possible settings	Default
	<ul style="list-style-type: none"> Objects outside the set distance range are evaluated as “No signal”. If a distance range is set, a blind spot directly behind this range results. The sensor cannot detect any objects within the blind spot. The size of the blind spot depends on the reflectance of the interfering objects in the hidden area. 	
Sensitivity	<p>The sensor has a very high sensitivity and can detect objects, measuring the distance to them, even when the signal is very weak. In applications where the object to be detected yields even weaker signals, e.g., due to large inclinations, it can be helpful to further increase the sensitivity or to amplify the optical signal.</p> <p>The higher the sensitivity, the more susceptible the sensor is to interference. The speed of the sensor is not reduced by the setting.</p> <p>Standard Corresponds to the default setting</p> <p>High Gain by factor 2</p> <p>Maximum Gain by factor 4</p>	Standard
Emitted light	<p>The sensor’s laser can be switched on or off.</p> <p>On Laser on</p> <p>Off Laser off</p> <p>The sensor no longer supplies a measured value.</p> <p>Note!</p> <ul style="list-style-type: none"> If an input is set as a laser-off input, the emitted light can also be switched on and off via the input. If the laser is switched off, the sensor behavior corresponds to the status “No signal.” 	On
Localization	<p>The supply voltage indicator of the sensor can be switched to flashing green. This allows the sensor to be easily located in a plant.</p> <p>On The supply voltage LED flashes green.</p> <p>Off LEDs in normal function.</p>	Off
Measured value unit	<p>The measured distance can be output in micrometers or mils.</p> <p>Micrometer Distance values output in μm.</p> <p>Mil Distance values read out in mil.</p>	micrometer

7.2 Laser Class 2 Activation

Sensors with a red laser have eye-safe laser class 1, which means that the sensors achieve very good performance. If very dark objects are to be detected at high speeds or in harsh environments, it can be helpful to increase the laser line and upgrade the sensor to laser class 2. For safety reasons, a license procedure is required for this.

To do this, the laser class 2 license DNNL028 must be ordered and a license request file must be sent by e-mail. This file, which contains the serial number, can be generated via wTeach.

Once the order has been placed, the laser class license key is provided by e-mail. This is then read in via wTeach. If licensing is successful, the parameter for setting the laser class is now activated.

In addition, a set of laser warning labels is supplied, which must be attached before the laser class is changed.



INFORMATION

The key is not transferable to other devices and only works with the device of the licensed serial number.



NOTICE

If the sensor is changed to laser class 2, the permissible ambient temperature changes to -30...50 °C.



WARNING

Before converting to laser class 2, the warning notices provided must be applied in accordance with the standard! In addition, the laser class 1 label on the sensor label must be covered with the enclosed laser class 2 sticker.



WARNING

After changing the laser class, the sensor must be restarted for the setting to become active.

Laser class license key	Enter the license key provided	–
Laser class	Setting the laser class used Laser class 1 Laser class 2	Laser class 1

7.3 Input/Output Functions (E/A)

7.3.1 Pin Function

The pin function is used to define the function of pins E/A1, E/A2, and E3, as these can be used for different functions.

Pin	Possible settings	Default
E/A1	<p>Switching output Switching point SSC1 is assigned to the switching output.</p> <p>Error output The error output switches if one of the assigned errors occurs; see table Status messages [▶ 30]</p> <p>Warning output The warning output switches if one of the assigned warnings occurs; see table Status messages [▶ 30].</p> <p>Laser-off input See E3 for an explanation</p> <p>Teach-in input See E3 for an explanation</p>	Switching output

Pin	Possible settings	Default
	<p>Deactivated The pin is deactivated.</p>	
E/A2	<p>Switching output Switching point SSC2 is assigned to the switching output.</p> <p>Antivalent switching output The switching output switches antivalently to switching output A1.</p> <p>Error output The error output switches if one of the assigned errors occurs; see table Status messages [▶ 30]</p> <p>Warning output The warning output switches if one of the assigned warnings occurs; see table Status messages [▶ 30].</p> <p>Laser-off input See E3 for an explanation</p> <p>Teach-in input See E3 for an explanation</p> <p>Deactivated The pin is deactivated.</p>	Switching output
E3	<p>Laser-off input The sensor's emitted light is deactivated as long as the input is activated. The sensor then does not send a measured value and sets the status to "No signal".</p> <p>Teach-In input Teach-in The outputs (switching outputs/analog output) can be set by following the same procedure as with the Teach-in key (see Configuration with Push of Button / Teach-In [▶ 18]). An activated input corresponds to a pressed Teach-in key.</p> <p>Locking If 18...30 V DC is continuously applied to the teach-in input, the teach-in key is locked and protected against inadvertent changes, like the input signal.</p> <p>Deactivated The pin is deactivated.</p>	Laser off Input

7.4 Output Functions

The output functions are used to set the physical outputs.

Digital Outputs

Function	Possible settings	Default
Polarity	<p>PNP</p> <p>NPN</p> <p>Push-pull</p>	PNP
Circuit	<p>NO Light switching (Normally Open)</p>	NO

Function	Possible settings	Default
	The output is high when the condition has been satisfied, depending on settings (switching point, warning, error). NC Dark switching (normally closed) The output is low when the condition has been fulfilled depending on the setting (switching point, warning, error).	
On-delay	0...10,000 ms	0 ms
Off-delay	0...10,000 ms	0 ms

7.5 Input Functions

The input functions are used to set the physical inputs.

Function	Possible settings	Default
Input mode	Supply voltage active Function is triggered as soon as supply voltage is applied to the input. Supply voltage inactive Function is triggered as soon as 0 V is applied to the input or the input is opened.	Supply voltage active

7.6 Switching Point Functions (SSC1/SSC2)

The switching point functions are used to set the two switching points, SSC1 and SSC2.

SSC1 is assigned to output O1 and SSC2 is assigned to output O2.

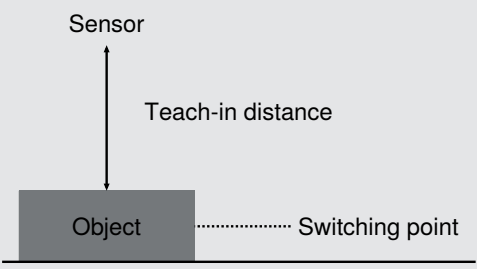
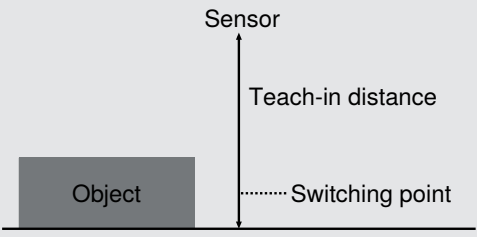
Function	Possible settings	Default
Teach-in	Starts the teach-in process.	
Teach-in mode	<p>Foreground Teach-In</p>  <p>Background Teach-In</p>  <p>Window Teach-In</p>	Foreground teach-in

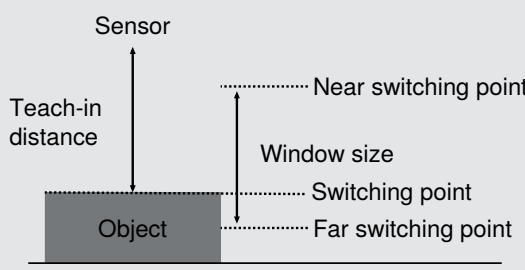
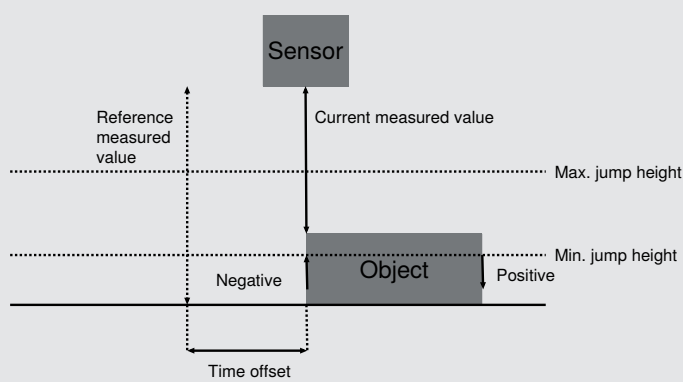
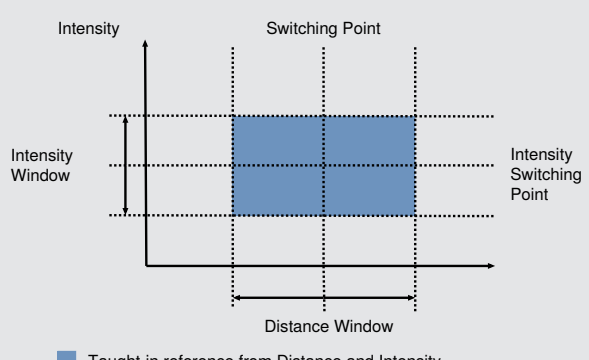
Function	Possible settings	Default
	 <p>Jump Detection</p> <p>In this mode, there is no switch to an absolute measured value, but rather to a measured value jump occurring between 2 measurements.</p>  <p>Distance and Intensity</p> <p>In this mode, the intensity of the received signal is also evaluated for distance. The sensor is taught in a reference that consists of a switching point for the distance and a switching point for the intensity. As soon as the sensor detects a deviation in distance or intensity, this is registered via the output.</p>  <p>Note!</p> <p>The teach-in function is necessary to ensure that the sensor works properly.</p>	
Switching point	60,000...660,000 μm Note If a distance range has been set, the switching point can only be set within the set distance range.	660,000 μm
Hysteresis mode	Hysteresis is the difference between the switch-on and switch-off points. Auto	Auto

Function	Possible settings	Default
	<p>The hysteresis is automatically calculated by the sensor in order to optimally adapt it to the respective situation. After a teach-in or change of the switching point, the hysteresis is recalculated and automatically updated in the hysteresis parameter. The information in the data sheet refers to the set switching point, e.g., switching point at 100 mm, hysteresis according to data sheet < 0.5% hysteresis < 0.5 mm</p> <p>Fixed</p> <p>The hysteresis is set to a fixed value in the Hysteresis parameter. This is not automatically adjusted during a teach-in or a change of the switching point. A small hysteresis is recommended for detecting flat objects against a background, while a larger hysteresis is recommended to ensure stable detection under changing conditions.</p>	
hysteresis	Absolute value of the hysteresis in hysteresis mode. Fixed 5 µm...660,000 µm	1,800 µm
Window switching point close	<p>In teach-in mode window teach-in</p> <p>Distance from the set window center to the switching point of the window close to the sensor.</p> <p>The window can be set so that it extends from the minimum setting range to the maximum setting range of the sensor. The minimum and maximum possible settings result from the respective set window center.</p>	30 mm
Window switching point far	<p>In teach-in mode window teach-in</p> <p>Distance from the set window center to the switching point of the window far from the sensor.</p> <p>The window can be set so that it extends from the minimum setting range to the maximum setting range of the sensor. The minimum and maximum possible settings result from the respective window center setting.</p>	30 mm
Jump height min	<p>In teach-in mode Jump detection</p> <p>The minimum jump height defines the jump in the measured value at which a jump event is to be detected.</p> <p>In the "Automatic" setting, the sensor calculates the smallest possible jump independently.</p> <p>0 = Automatic 8 µm...660,000 µm</p>	Automatic
Maximum jump height	<p>In teach-in mode, jump detection</p> <p>The max. jump height defines the maximum jump in the measured value at which a jump event is to be detected.</p> <p>In the "No restriction" setting, there is no limit to the max. jump height. A change from a valid measured value to "No measured value" is evaluated as a negative jump.</p> <p>4294967295 = No restriction 8 µm...660,000 µm</p>	no limit
Jump direction	<p>In teach-in mode, jump detection</p> <p>Positive</p> <p>A jump is detected when the measured value jumps to a higher value, i.e. the contrast value becomes brighter.</p> <p>Negative</p> <p>A jump is detected when the measured value jumps to a lower value, i.e. the contrast value becomes darker.</p> <p>Both</p>	Negative

Function	Possible settings	Default
	A jump is detected for both positive and negative.	
Cycle offset	In teach-in mode Jump detection The cycle offset specifies the time-shifted reference measured value with which the current measured value is to be compared in order to detect the jump. 1...256 Cycles	50
Jump pulse duration	In teach-in mode Jump detection 0 = hold The output remains active until the next jump in the opposite jump direction is detected. A combination with the jump direction "Both" is not permitted here. 1...10,000 ms When a jump is detected, the output is activated with the corresponding pulse length.	0
Distance Window	In teach-in mode Distance + Intensity Distance from the set switching point (center of the window) to the boundaries of the window. The distance window is symmetrical around the switching point. 5 µm...10,000 µm	1,800 µm
Switching point Intensity	In teach-in mode Distance + intensity Switching point of intensity in digits 1...1,000,000	30,000
Intensity window	In teach-in mode, distance + intensity from the set switching point intensity (center of the window) to the limits of the window. The intensity window is symmetrical around the switching point. 1...50%	4%

7.7 Differential and Thickness Measurement

In this operating mode, two sensors work together to calculate a difference or thickness based on the individual measurement results.

This eliminates the need for complex programming in the controller, and the system already provides a calculated value. This value can then be used for a switching function or output via an analog output. Additionally, the calculated difference or thickness is output as an absolute value via IO-Link.

Mechanical Design

differential measurement

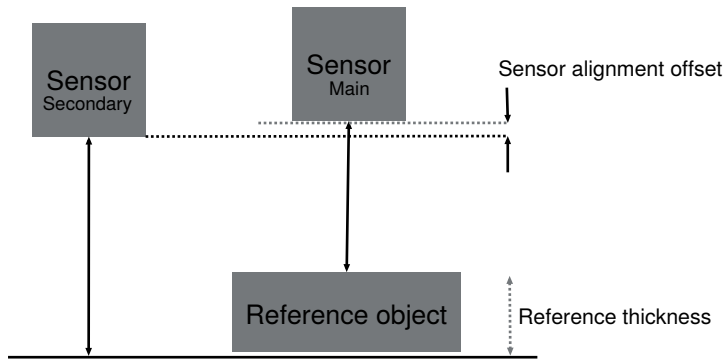

thickness measurement

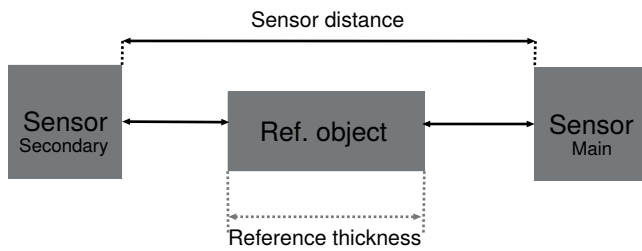

It is recommended to arrange the sensors so that no area between the sensors remains uncovered by their measuring range (Figs. 1 and 2). If this is the case, the object to be measured must be wider than the uncovered area (Fig. 3).

The sensors must be aligned so that the transmitted beams strike the front window of the opposite sensor. Care must be taken to ensure that they do not strike the emitter or receiver directly.

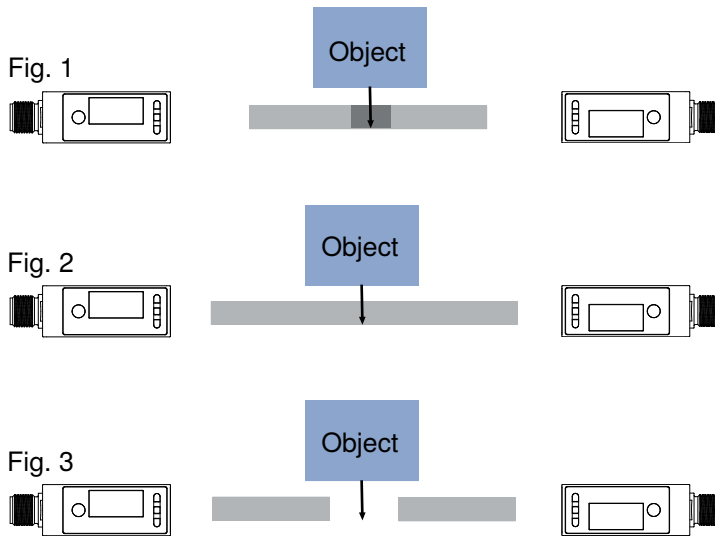

■ Working range

Wiring

With adapter

The ZC4G004 adapter can be used for easy wiring. In this case, the sensors must simply be connected as shown. The sensors are automatically parameterized for the appropriate operating modes as soon as they are connected. In this case, the main sensor is set to "thickness measurement" mode. If a differential measurement is to be performed, the mode of operation must be adjusted accordingly.

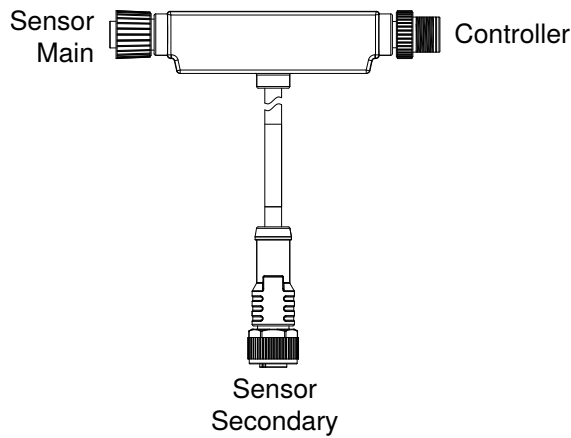

The adapter's connections can be extended using connection cables. Note that 5-pin connection cables must be used for the sensors. When connecting an IO-Link master on the control side, a 4-pin connection cable must be used.

Direct Wiring

As an alternative to using the adapter, wiring can also be done directly via terminal blocks or within a controller. To do this, connect the sensors according to the following wiring diagram. The operating modes must be set manually in each sensor.

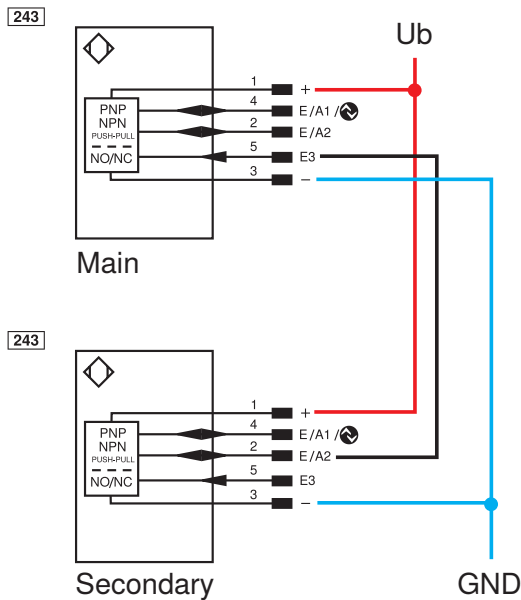

The example shows the use of 2 digital sensors. In this case, switching points can be set via pins 2 and 4 on the main sensor based on the calculated difference or thickness. Two analog sensors or a combination of digital and analog sensors can also be used. In that case, the calculated thickness can then be tapped as an analog signal at the analog output of the main sensor.



NOTICE

Sensors with different measuring ranges can also be combined. In this case, the respective working ranges must be taken into account during installation.

A combination of versions with red and blue lasers is also possible. This combination is recommended if, due to the installation situation, the sensors interfere with each other when no object is present.

Calibration

To perform thickness or differential measurements, the system must be referenced after mechanical assembly and wiring.

During this process, the sensors automatically calibrate their distances from one another so that the measurement results can be calculated according to the setup. Calibration can be performed via the teach-in key or Enter button, via the OLED menu, Bluetooth, or via IO-Link.

The reference object must be positioned in the measuring system according to the mechanical setup. For referencing via the teach-in key, hold it down for 10 seconds until the two LEDs begin to flash. Then release the key. The LEDs will flash twice briefly to confirm. The sensors are now referenced.

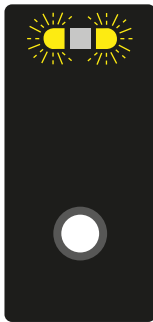

Outputs

If a sensor is in the Main Thickness/Difference mode of operation, the calculated thickness or difference is used for output at the outputs.

SSC1/SSC2

All settings can be configured identically to standalone operation. However, the switching points do not correspond to a distance, but rather to the thickness/difference. The switching points are set via separate parameters. All other settings are configured using the general parameters of SSC1/SSC2.

Settings

Function	Possible settings	Default
Mode of operation	Stand Alone The device functions as a stand-alone device. Secondary The sensor provides measurement data for a main device. Main Thickness The sensor performs a thickness measurement using the connected secondary. Main Difference The sensor performs a differential measurement using the connected secondary. Automatic	Automatic

Function	Possible settings	Default
	This setting is used to enable automatic detection of the ZC4G004 adapter, when in use, and to preset the operating mode according to the connection. The main sensor is set to Thickness mode.	
Referencing	Start of the referencing process To do so, the reference object must be placed in the measuring system, depending on the mechanical layout, and referencing started.	
Sensor alignment offset (difference)	When referencing, the offset is calculated using the specified reference thickness.	0 µm
Sensor distance (thickness)	When referencing, the sensor distance is calculated using the specified reference thickness.	1,320,000 µm
Reference thickness	The reference thickness corresponds to the true thickness of the reference object. This thickness is used by the sensor to calculate the absolute value that is output by the main sensor via IO-Link.	0 µm
Switching point	Switching point in relation to a thickness or difference used for the function of SSC1 and SSC2.	

7.8 Condition Monitoring Functions

7.8.1 Status Message Function

The sensor provides various status messages. Due to the process data structure, four status messages can be transmitted as individual process data.

These parameters can be used to set the status messages that are transmitted via the process data.

Function	Possible settings	Default
Message 1	See table "Status Messages" [► 30]	Warning signal
Message 2	See table "Status Messages" [► 30]	Ambient light
Message 3	See table "Status Messages" [► 30]	Temperature too high
Message 4	See table "Status Messages" [► 30]	Short circuit

7.8.2 Warning/Error Output Function

The status messages used to trigger the collective message can be defined for the warning output and the error output respectively. The status messages are OR-linked so that the output is activated when one of the defined status messages is activated.

Function	Possible settings	Default
Warning output	See table "Status Messages"	Signal warning, optics dirty, ambient light, temperature too high, temperature too low, undervoltage, interference in the working range
Error output	See table "Status Messages"	Object too close, object too far, no signal, device error, over-temperature, short circuit

Status Messages

Warning	
Undervoltage	The supply voltage is too low.
Warning signal	The object reflects too little light.

Warning	
Ambient light	Object detection is impeded by ambient light.
Overexposure	The sensor signal is overexposed.
Temperature too high	The sensor's internal temperature is high.
Temperature too low	The sensor's internal temperature is low.
Emitted light off	The sensor's emitted light is switched off.

Error	
Short circuit	A short circuit has occurred on at least one pin.
No signal	The sensor is not receiving a signal.
Object too close	The object is below the setting range or the set measuring range.
Object too far	The object is above the setting range or the set measuring range.
Temperature error	Temperature is outside permissible range. To protect the emitting unit, the emitted light is switched off.
Device error	A hardware error has occurred. For safety reasons, the emitted light is switched off.
Laser error	There is an error in the laser module. For safety reasons, the laser is switched off.

7.8.3 Simulation Functions

This function simulates the behavior of the sensor regardless of the current status and measured value. This can be used to check whether a plant in which the sensor is integrated reacts correctly to the data supplied by the sensor and processes them accordingly.

If a measured value is specified, the sensor behaves as if the specified measured value corresponds to the actual measured value. This means that the behavior of the outputs and status messages is simulated according to the specified measured value.

In addition, the individual outputs and status messages can be simulated separately from the measured value.

Function	Possible settings	Default
Simulation mode	On Off	Off
Test measured value	Current measured value min...max. measuring range	Current measured value
SSC1 Test	According to the measured value On Off	According to measured value
SSC2 Test	According to the measured value On Off	According to measured value
Status messages test	Tests the individual status messages according to the measured value On Off	According to measured value



INFORMATION

Output A1 is used for IO-Link communication in this function and cannot be simulated.

Simulation mode ends automatically as soon as the power supply is interrupted.

8 IO-Link

The sensors can exchange parameters and process data via IO-Link. The parameters can be used to make many additional settings on the device. The process data transmit cyclical data and condition monitoring.

To this end, the sensor is connected to a suitable IO-Link master (see product detail page/complementary products). The interface protocol and the IODD can be found at www.wenglor.com in the download area for the respective product.

8.1 Parameters

The parameters that can be configured via IO-Link are given in the functional description in the section Function description [▶ 19].

8.2 Condition Monitoring/Process Data

The data described in the following section can be read or written cyclically via IO-Link/process data.

8.2.1 Process Data In

Data	Meaning
Measured value	Measured distance in micrometers or mil. As the sensor cannot determine a measured value in the following error cases, substitute values are read out: No signal: 0x7FFFFFFC / 2147483644 Object too close: 0x80000008 / -2147483640 Object too far: 0x7FFFFFF8 / 2147483640
Scale	Scaling of the measured value to the base length unit; -6 corresponds to μm .
SSC1	Switching point 1
SSC2	Switching point 2
Warning	Collective warning in the event of one of the warning status messages (see table "Status messages") in the error output function)
Error	Collective warning in the event of one of the error status messages (see table "Status messages") in error output function.
Message 1	Status message 1 read out see Status Message Function [▶ 30]
Message 2	Status message 2 read out see Status Message Function [▶ 30]
Message 3	Status message 3 read out see Status Message Function [▶ 30]
Message 4	Status message 4 read out see Status Message Function [▶ 30]

8.2.2 Process Data Out

Data	Meaning
Emitted light	Transmit signal on/off
Localization	Sensor flashes for easy sensor location
Teach-in SSC1	Starts the teach-in process for SSC1
Teach-in SSC2	Starts the teach-in process for SSC2

8.2.3 Events

Events are diagnostic information that is standardized by IO-Link and exchanged between the IO-Link master and the device. The following events are supported:

Name	Event code	Type	Specification
Maintenance necessary: Clean	0x8C40	Notification	IO-Link
Device error – unknown error	0x1000	Error	IO-Link
Short circuit – check installation	0x7710	Error	IO-Link
Device temperature too high: Remove heat source	0x4210	Warning	IO-Link
Device temperature too low: Isolate device	0x4220	Warning	IO-Link
Temperature error: Overload	0x4000	Error	IO-Link
Supply voltage too low – check tolerances	0x5111	Warning	IO-Link

9 wTeach2 Configuration Software

For information on installing and connecting the wTeach2 software and its structure, as well as information on the general functions, see the wTeach2 operating instructions. They can be found online in the download area at www.wenglor.com under order number DNNF005.

The wTeach2 operating software can be used to configure all functions, in accordance with the function description [► 19], and read out the IO-Link process data.

In addition, there are functions that are only available via wTeach. These are described in the following sections.

9.1 Laser Class 2 Licensing



Clicking on the corresponding icon in the menu bar opens a dialog window.

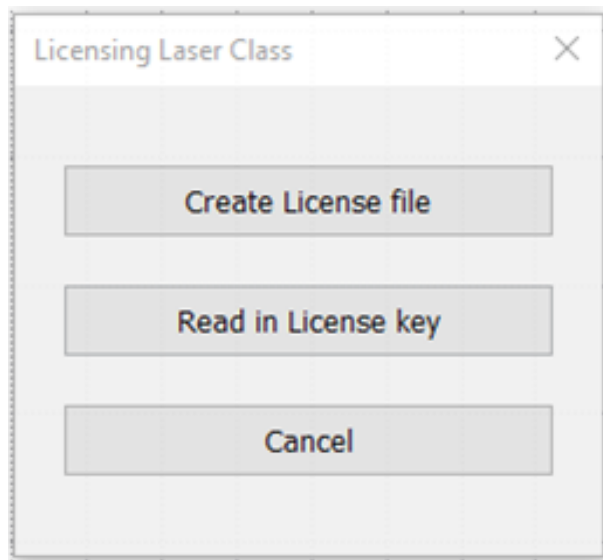

The “Create License file” button is first pressed in the dialog window. Another window opens to select the location for saving the license file. After selection and confirmation, the corresponding file with the extension .3pk is saved.

This file must be sent when ordering the license.

wenglor will then provide the license key. This is sent in the form of a corresponding file with the extension .p3l.

To carry out the licensing, the “Read in License key” button must be pressed in the dialog window. The .p3l file is now selected and uploaded.

If licensing is successful, the “Laser class” parameter is enabled and this can be set accordingly.

The sensor must be restarted for the setting to become active.



WARNING

Before switching to laser class 2, the provided warning notices must be affixed in accordance with standard specifications! In addition, the no longer applicable laser class 1 marking on the type plate of the sensor must be covered with the enclosed laser class 2 label.

9.2 Calling Up the Calibration Protocol



To access the sensor-specific calibration protocol, click on the corresponding icon in the menu bar.



Calibration Protocol

Laser Distance Sensor Triangulation

Supplier: wenglor sensoric GmbH
Order Number: P3PC312
Serial Number: 750126317

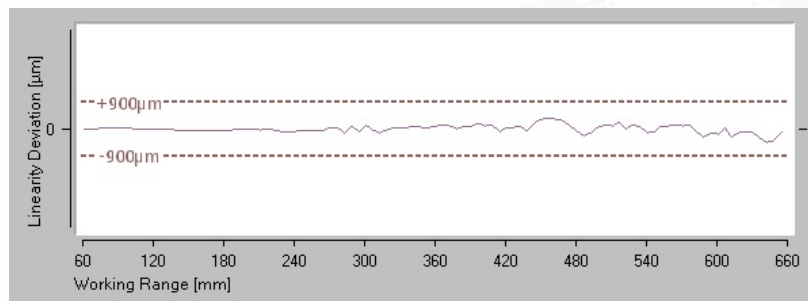

Measurement Conditions

Working Range	60 ... 660 mm
Linearity Deviation	900µm
Measured Surface	White (90%) lambertian
Filter	3 (default)
Sensor warmed up	>5min

Differences of these Data can appear because of:

- Target material and surface
- Sensor mounting (tilt)
- Temperature fluctuation during the measurement
- Circulation of warm air between sensor and target
- Ambient light

Document was created electronically and thus valid without signature

Inspector: wenglor
Data: 06.04.2023



A window opens to select the location for saving the PDF document. After selection and confirmation, the document is saved accordingly.

10 Maintenance Instructions



NOTICE

This wenglor product is maintenance-free.

Cleaning and inspection of the plug connections at regular intervals are advisable.

Do not clean the product with solvents or cleaning agents that could damage the product.

The product must be protected against contamination during initial start-up.

11 Proper Disposal

wenglor sensoric GmbH does not accept the return of unusable or irreparable products. Respectively valid national waste disposal regulations apply to product disposal.

12 Declarations of Conformity

Declarations of conformity can be found on our website at www.wenglor.com in the product's separate download area.