

# Operating Instructions

## **P1KH008**

# **Reflex Sensor with Background Suppression**



EN



# Table of Contents

<b>1</b>	<b>General</b> .....	<b>3</b>
1.1	Information Concerning these Instructions .....	3
1.2	Explanation of Symbols .....	3
1.3	Limitation of Liability .....	4
1.4	Copyrights .....	4
<b>2</b>	<b>For Your Safety</b> .....	<b>5</b>
2.1	Use for Intended Purpose .....	5
2.2	Use for Other than the Intended Purpose .....	5
2.3	Personnel Qualifications .....	5
2.4	Modification of Products .....	6
2.5	General Safety Precautions .....	6
2.6	Laser Warnings .....	6
2.7	Approvals and Protection Class .....	6
<b>3</b>	<b>Technical Data</b> .....	<b>7</b>
3.1	General Data .....	7
3.1.1	Light Spot Diameter .....	8
3.1.2	Switching Distance Deviation .....	8
3.2	Housing Dimensions .....	8
3.3	Control Panel .....	9
3.4	Complementary Products .....	9
3.5	Scope of delivery .....	9
<b>4</b>	<b>Transport and Storage</b> .....	<b>10</b>
4.1	Transport .....	10
4.2	Storage .....	10
<b>5</b>	<b>Installation and Electrical Connection</b> .....	<b>11</b>
5.1	Installation .....	11
5.2	Electrical Connection .....	11
5.3	Diagnosis .....	12
<b>6</b>	<b>Settings</b> .....	<b>14</b>
6.1	Adjustment via Potentiometer .....	14
6.2	Setting via IO-Link and wTeach2 .....	14
<b>7</b>	<b>Maintenance Instructions</b> .....	<b>15</b>
<b>8</b>	<b>Proper Disposal</b> .....	<b>16</b>
<b>9</b>	<b>Declarations of Conformity</b> .....	<b>17</b>

# 1 General

## 1.1 Information Concerning these Instructions

- These instructions make it possible to use the product safely and efficiently.
- These instructions are an integral part of the product and must be kept on hand for the entire duration of its service life.
- Local accident prevention regulations and national work safety regulations must be complied with as well.
- The product is subject to further technical development, and thus the information contained in these operating instructions may also be subject to change. The current version can be found at [www.wenglor.com](http://www.wenglor.com) in the product's separate download area.



### INFORMATION

The operating instructions must be read carefully before using the product and must be kept on hand for later reference.

## 1.2 Explanation of Symbols

- Safety precautions and warnings are emphasized by means of symbols and signal words.
- Safe use of the product is only possible if these safety precautions and warnings are adhered to.

The safety precautions and warnings are laid out in accordance with the following principle:

### SIGNAL WORD

#### Type and source of danger!

Possible consequences in the event that the hazard is disregarded.

→ Measures for averting the hazard.

The meanings of the signal words, as well as the scope of the associated hazards, are listed below:



### ⚠ DANGER

This signal word indicates a hazard with a high degree of risk which, if not avoided, results in death or severe injury.



### ⚠ WARNING

This signal word indicates a hazard with a medium degree of risk which, if not avoided, may result in death or severe injury.



### ⚠ CAUTION

This signal word indicates a hazard with a low degree of risk which, if not avoided, may result in minor or moderate injury.



### NOTICE

This signal word draws attention to a potentially hazardous situation which, if not avoided, may result in property damage.



## INFORMATION

Information draws attention to useful tips and suggestions, as well as information on efficient, error-free use.

---

### 1.3 Limitation of Liability

- The product has been developed in consideration of the current state-of-the-art technology, as well as applicable standards and guidelines. Subject to change without notice.
- A valid declaration of conformity can be accessed at [www.wenglor.com](http://www.wenglor.com) in the product's separate download area.
- wenglor sensoric elektronische Geräte GmbH (hereinafter referred to as "wenglor") excludes all liability in the event of:
  - Non-compliance with the instructions
  - Use of the product for purposes other than those intended.
  - Use by untrained personnel.
  - Use of unapproved spare parts.
  - Unapproved modification of products.
- These operating instructions do not include any guarantees from wenglor with regard to the described procedures or specific product characteristics.
- wenglor assumes no liability for printing errors or other inaccuracies contained in these operating instructions unless wenglor was verifiably aware of such errors at the point in time at which the operating instructions were prepared.

### 1.4 Copyrights

- The contents of these instructions are protected by copyright law.
- All rights are reserved by wenglor.
- Commercial reproduction or any other commercial use of the provided content and information, in particular graphics and images, is not permitted without previous written consent from wenglor.

## 2 For Your Safety

### 2.1 Use for Intended Purpose

#### Reflex Sensors with Background Suppression

Reflex sensors with background suppression evaluate the light reflected by objects. As they operate according to the angle measurement principle, the object's color, shape, and surface finish have practically no influence on the detection range. Even dark objects are reliably recognized against bright backgrounds. When the object reaches the selected detection range, the sensor's output is switched.

#### This product can be used in the following industry sectors:

- Special-purpose mechanical engineering
- Heavy mechanical engineering
- Logistics
- Automotive industry
- Food industry
- Packaging industry
- Pharmaceuticals industry
- Plastics industry
- Woodworking industry
- Consumer goods industry
- Paper industry
- Electronics industry
- Glass industry
- Steel industry
- Aviation industry
- Chemicals industry
- Alternative energies
- Raw materials extraction

### 2.2 Use for Other than the Intended Purpose

- Not a safety component in accordance with 2006/42/EC (Machinery Directive).
- The product is not suitable for use in potentially explosive atmospheres.
- The product may be used only with accessories supplied or approved by wenglor, or in combination with approved products. A list of approved accessories and combination products can be found at [www.wenglor.com](http://www.wenglor.com) on the product detail page.



#### **DANGER**

#### **Risk of personal injury or property damage in case of use for other than the intended purpose!**

Use for other than the intended purpose may lead to hazardous situations.

→ Observe instructions regarding use for intended purpose.

### 2.3 Personnel Qualifications

- Suitable technical training is a prerequisite.
- In-house electronics training is required.
- Trained personnel who use the product must have (permanent) access to the operating instructions.



## **DANGER**

### **Risk of personal injury or property damage in case of incorrect initial start-up and maintenance!**

Personal injury and damage to equipment may occur.

→ Adequate training and qualification of personnel

## 2.4 Modification of Products



## **DANGER**

### **Risk of personal injury or property damage if the product is modified!**

Personal injury and damage to equipment may occur. Noncompliance may result in loss of the CE and/or UKCA mark and voiding of the warranty.

→ Modification of the product is not permitted

## 2.5 General Safety Precautions



## **INFORMATION**

These instructions are an integral part of the product and must be kept on hand for the entire duration of its service life.

In the event of possible changes, the current version of the operating instructions can be found at [www.wenglor.com](http://www.wenglor.com) in the product's separate download area.

Read the operating instructions carefully before using the product.

Protect the sensor against contamination and mechanical influences.

## 2.6 Laser Warnings

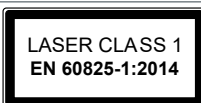

### **Laser Class 1 (EN 60825-1)**

Applicable standards and safety regulations must be observed.

## 2.7 Approvals and Protection Class

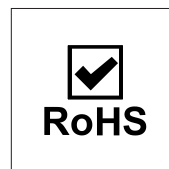
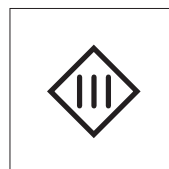
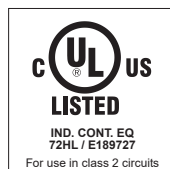

## 3 Technical Data

### 3.1 General Data

Technical Data	
<b>Optical Data</b>	
Range	120 mm
Setting Range	30 ... 120 mm
Switching Hysteresis	< 10 %
Light Source	Laser (red)
Wavelength	680 nm
Laser Class (EN 60825-1)	1
Service Life (T = +25 °C)	100000 h
Max. Ambient Light	10000 Lux
Light Spot Diameter	see section Light Spot Diameter [► 8]
<b>Electrical Data</b>	
Supply Voltage	10 ... 30 V DC
Supply Voltage with IO-Link	18 ... 30 V DC
Current Consumption (U <sub>b</sub> = 24 V)	< 15 mA
Switching Frequency	1000 Hz
Switching Frequency (interference-free mode)	500 Hz
Response Time	0.5 ms
Response time (interference-free mode)	1 ms
Temperature Drift	< 5 %
Temperature range	-40 ... 50 °C
Switching Output Voltage Drop	100 mA
Switching Output/Switching Current	< 2 V
Residual Current Switching Output	< 50 µA
Short Circuit Protection	yes
Reverse Polarity Protection	yes
Overload Protection	yes
Lockable	yes
FDA Accession Number	1710976-001
Interface	IO-Link V1.1
Protection Class	III
<b>Mechanical Data</b>	
Setting Method	Potentiometer
Housing Material	Plastic, ABS/PC
Degree of Protection	IP67/IP68
Connection	M8 × 1; 3-pin
Optic Cover	Plastic, PMMA
<b>Safety-relevant Data</b>	
MTTFd (EN ISO 13849-1)	1647.45 a
<b>Output Functions</b>	
Output	PNP
	NO

### 3.1.1 Light Spot Diameter

Detection Range	40 mm	80 mm	120 mm
Light Spot Diameter	2,5 mm	1,5 mm	1 mm

### 3.1.2 Switching Distance Deviation

Typical characteristic curve based on Kodak white (90% remission).

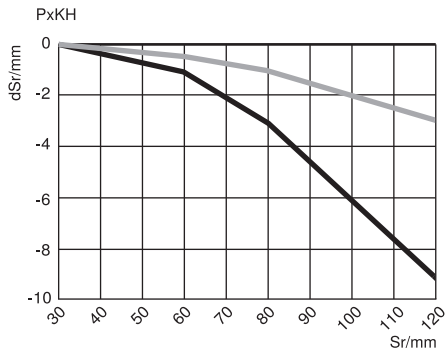

Sr = switching distance

dSr = change in switching distance

Black, 6% remission

Gray, 18% remission

### 3.2 Housing Dimensions

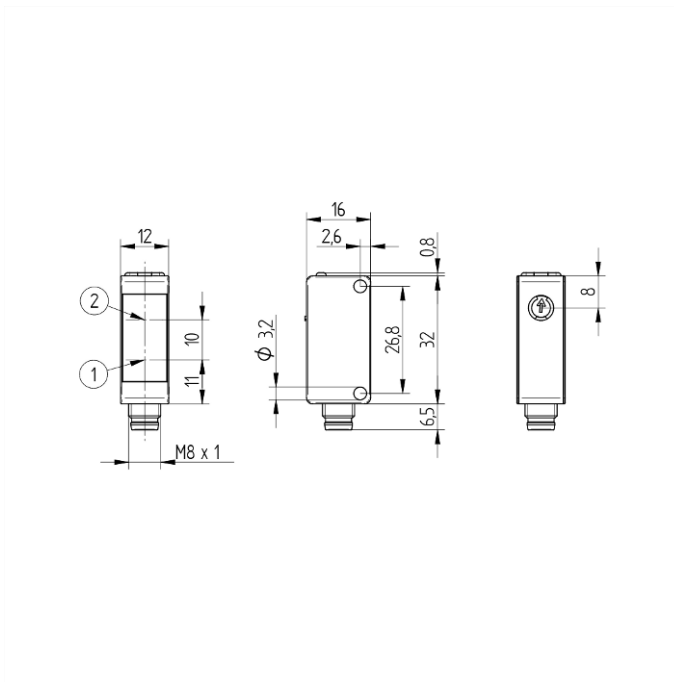

① = emitter diode

② = receiver diode

M3 screw = 0.5 Nm

Switching distance adjuster = 40 Nmm

Dimensions in mm (1 mm = 0.03937 inch)

### 3.3 Control Panel

1K1



---

05 = switching distance adjuster

30 = switching status indicator / contamination warning

---

68 = power LED

---

### 3.4 Complementary Products

wenglor offers you the right connection and mounting technology as well as other accessories for your product. You can find this at [www.wenglor.com](http://www.wenglor.com) on the product details page at the bottom.

### 3.5 Scope of delivery

- Sensor
- Safety precaution

## 4 Transport and Storage

### 4.1 Transport

Upon receipt of shipment, the goods must be inspected for damage in transit. In the case of damage, conditionally accept the package and notify the manufacturer of the damage. Then return the device, making reference to damage in transit.

### 4.2 Storage

The following points must be taken into consideration with regard to storage:

- Do not store the product outdoors.
- Store the product in a dry, dust-free place.
- Protect the product against mechanical impacts.
- Protect the product against exposure to direct sunlight.



#### NOTICE

#### **Risk of property damage in case of improper storage!**

The product may be damaged.

→ Storage instructions must be complied with.

---

# 5 Installation and Electrical Connection

## 5.1 Installation

- Protect the product from contamination during installation.
- Observe all applicable electrical and mechanical regulations, standards and safety rules.
- Protect the product against mechanical influences.
- Make sure that the sensor is mounted in a mechanically secure fashion.



### NOTICE

#### Risk of property damage in case of improper installation!

The product may be damaged!

→ Comply with installation instructions.



### CAUTION

#### Risk of personal injury or property damage during installation!

Personal injury and damage to the product may occur.

→ Ensure a safe installation environment.

## 5.2 Electrical Connection

- Wire the sensor in accordance with the connection diagram.
- Switch on the supply voltage (see section Technical Data [► 7])
- If using IO-Link, connect the sensor to 18...30 V DC.
- If not using IO-Link, connect the sensor to 10...30 V DC.





### DANGER

#### Risk of personal injury or property damage due to electric current.

Voltage-conducting parts may cause personal injury or damage to equipment.

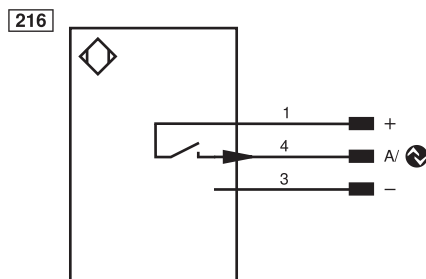
→ The electric device may be connected by appropriately qualified personnel only.



Legend					
+	Supply Voltage +	PT	Platinum measuring resistor	ENARs422	Encoder A/Ā (TTL)
–	Supply Voltage 0 V	nc	Not connected	ENBRs422	Encoder B/B̄ (TTL)
~	Supply Voltage (AC Voltage)	U	Test Input	ENA	Encoder A
A	Switching Output (NO)	Ū	Test Input inverted	ENb	Encoder B
Ā	Switching Output (NC)	W	Trigger Input	AMIN	Digital output MIN
V	Contamination/Error Output (NO)	W–	Ground for the Trigger Input	AMAX	Digital output MAX
Ṽ	Contamination/Error Output (NC)	O	Analog Output	AOK	Digital output OK
E	Input (analog or digital)	O–	Ground for the Analog Output	SY In	Synchronization In
T	Teach Input	BZ	Block Discharge	SY OUT	Synchronization OUT
R	Reset input	AMv	Valve Output	OLT	Brightness output
Z	Time Delay (activation)	a	Valve Control Output +	M	Maintenance
S	Shielding	b	Valve Control Output 0 V	rsv	Reserved
RxD	Interface Receive Path	SY	Synchronization	Wire Colors according to DIN IEC 60757	
TxD	Interface Send Path	SY–	Ground for the Synchronization	BK	Black
RDY	Ready	E+	Receiver-Line	BN	Brown
GND	Ground	S+	Emitter-Line	RD	Red
CL	Clock	⊕	Grounding	OG	Orange
E/A	Output/Input programmable	SnR	Switching Distance Reduction	YE	Yellow
	IO-Link	Rx+/-	Ethernet Receive Path	GN	Green
PoE	Power over Ethernet	Tx+/-	Ethernet Send Path	BU	Blue
IN	Safety Input	Bus	Interfaces-Bus A(+)/B(-)	VT	Violet
OSSD	Safety Output	La	Emitted Light disengageable	GY	Grey
Signal	Signal Output	Mag	Magnet activation	WH	White
BI_D+/-	Ethernet Gigabit bidirect. data line (A-D)	RES	Input confirmation	PK	Pink
EN0 RS422	Encoder 0-pulse 0/0̄ (TTL)	EDM	Contacting Monitoring	GNYE	Green/Yellow

## 5.3 Diagnosis

Causes triggering the contamination warning (flashing LED):

Display LED	Diagnosis/Cause	Elimination
Continuous flashing at approx. 2.5 Hz	Contamination	Carefully clean the optic cover with a cloth
	Aged emitter diode	Replace the sensor
	Unreliable working range	<ul style="list-style-type: none"> <li>• Increase the sensor's switching distance</li> <li>• Reduce distance between sensor and object</li> </ul>
Continuous flashing at approx. 5 Hz	Short circuit	Check electrical wiring and eliminate the short circuit
	Over-temperature	Disconnect the sensor from the supply voltage and allow it to cool
	Hardware error	Replace the sensor

## Contamination Warning Flowcharts

Reflex Mode			
	<b>no contamination</b>		
Object	not detected	detected	not detected
Switching Status Indicator NO	off <input type="radio"/>	on <input checked="" type="radio"/>	off <input type="radio"/>
Switching Status Indicator NC	on <input checked="" type="radio"/>	off <input type="radio"/>	on <input checked="" type="radio"/>
	<b>beginning contamination</b>		
Object	not detected	detected	not detected
Switching Status Indicator NO	off <input type="radio"/>	blinking <input type="radio"/>	off <input type="radio"/>
Switching Status Indicator NC	on <input checked="" type="radio"/>	blinking <input type="radio"/>	on <input checked="" type="radio"/>
	<b>advanced contamination</b>		
Object	not detected	not detected	not detected
Switching Status Indicator NO	off <input type="radio"/>	off <input type="radio"/>	off <input type="radio"/>
Switching Status Indicator NC	on <input checked="" type="radio"/>	on <input checked="" type="radio"/>	on <input checked="" type="radio"/>



### NOTICE

#### Required action in case of fault:

1. Shut down the machine.
2. Analyze and eliminate the cause of error with the aid of the diagnostics information.
3. If the error cannot be eliminated, please contact wenglor's support department.
4. Do not operate in case of indeterminate malfunctioning.
5. The machine must be shut down if the error cannot be definitively explained or properly eliminated.



### DANGER

#### Risk of personal injury or property damage in case of non-compliance!

The system's safety function is disabled. Personal injury and damage to equipment may occur.

→ Required action as specified in case of fault.

## 6 Settings

The sensor can be set via the control, IO-Link and wTeach2. The different setting options are outlined below.

### 6.1 Adjustment via Potentiometer

#### **Object detection directly in front of a background or surface**

- Adjust the sensor and mount it securely so that the light spot falls perpendicularly onto the object to be detected.
- Turn the potentiometer to the right stop or maximum switching distance setting.
- Remove the object, then slowly turn the potentiometer back until the output switches. The background or surface is now masked out.
- Place the object back under the light spot and check whether the sensor switches on again.

#### **Detection of objects without a distracting background**

- Adjust the sensor and mount it securely so that the light spot falls perpendicularly onto the object to be detected.
- Turn the potentiometer to the left stop or minimum switching distance setting.
- Turn the potentiometer until the sensor switches on, and turn it slightly further if necessary to increase switching reliability.

### 6.2 Setting via IO-Link and wTeach2

The sensors can exchange parameters and process data via IO-Link. The parameters can be used to make many additional settings on the device. The process data transmit cyclical data and condition monitoring.

To this end, the sensor is connected to a suitable IO-Link master (see product detail page/complementary products). The interface protocol and the IODD can be found at [www.wenglor.com](http://www.wenglor.com) in the download area for the respective product.

For information on installing and connecting the wTeach2 software and its structure, as well as information on the general functions, see the wTeach2 operating instructions. They can be found online in the download area at [www.wenglor.com](http://www.wenglor.com) under order number DNNF005.

## 7 Maintenance Instructions



### NOTICE

This wenglor sensor is maintenance-free.

Cleaning and inspection of the plug connections at regular intervals are advisable.

Do not clean the sensor with solvents or cleaning agents that could damage the product.

The product must be protected against contamination during initial start-up.

---

## 8 Proper Disposal

wenglor sensoric GmbH does not accept the return of unusable or irreparable products. Respectively valid national waste disposal regulations apply to product disposal.

## 9 **Declarations of Conformity**

Declarations of conformity can be found on our website at [www.wenglor.com](http://www.wenglor.com) in the product's separate download area.