

Operating Instructions

P1PW005

Contrast Sensor



EN



Table of Contents

1	General	4
1.1	Information Concerning these Instructions	4
1.2	Explanation of Symbols	4
1.3	Limitation of Liability	5
1.4	Copyrights	5
2	For Your Safety	6
2.1	Use for Intended Purpose	6
2.2	Use for Other than the Intended Purpose	6
2.3	Personnel Qualifications	6
2.4	Modification of Products	7
2.5	General Safety Precautions	7
2.6	Approvals and Protection Class	7
3	Technical Data	8
3.1	General data	8
3.2	Housing Dimensions	9
3.3	Control Panel	9
3.4	Complementary Products	9
3.5	Scope of delivery	10
4	Transport and Storage	11
4.1	Transport	11
4.2	Storage	11
5	Installation and Electrical Connection	12
5.1	Installation	12
5.2	Adjustment	12
5.3	Electrical Connection	12
5.4	Diagnosis	13
5.5	LED Bar Display	14
5.6	Troubleshooting	14
6	Settings	16
6.1	Configuration with Push of Button / Teach-In	16
6.1.1	Teach-in in Print Mark Mode of Operation	16
6.1.2	Teach-In in Contrast Mode of Operation	18
6.1.3	Teach-In in Color Mode of Operation	19
6.2	Operating Modes	19
6.2.1	Display the Mode of Operation	19
6.2.2	Print Marks Mode	20
6.2.3	Contrast Mode	20
6.2.4	Color Mode	20
6.3	Setting the Operating Mode	21
7	IO-Link	22
7.1	Settings via IO-Link/Parameters	22
7.1.1	Sensor Functions	22
7.1.2	Input/Output Functions (E/A)	23
7.1.3	Switching Point Functions (SSC1)	24
7.1.4	Condition Monitoring/Process Data	26
8	Maintenance Instructions	29

9 Proper Disposal 30
10 Declarations of Conformity..... 31

1 General

1.1 Information Concerning these Instructions

- These instructions make it possible to use the product safely and efficiently.
- These instructions are an integral part of the product and must be kept on hand for the entire duration of its service life.
- Local accident prevention regulations and national work safety regulations must be complied with as well.
- The product is subject to further technical development, and thus the information contained in these operating instructions may also be subject to change. The current version can be found at www.wenglor.com in the product's separate download area.



INFORMATION

The operating instructions must be read carefully before using the product and must be kept on hand for later reference.

1.2 Explanation of Symbols

- Safety precautions and warnings are emphasized by means of symbols and signal words.
- Safe use of the product is only possible if these safety precautions and warnings are adhered to.

The safety precautions and warnings are laid out in accordance with the following principle:

SIGNAL WORD

Type and source of danger!

Possible consequences in the event that the hazard is disregarded.

→ Measures for averting the hazard.

The meanings of the signal words, as well as the scope of the associated hazards, are listed below:



DANGER

This signal word indicates a hazard with a high degree of risk which, if not avoided, results in death or severe injury.



WARNING

This signal word indicates a hazard with a medium degree of risk which, if not avoided, may result in death or severe injury.



CAUTION

This signal word indicates a hazard with a low degree of risk which, if not avoided, may result in minor or moderate injury.



NOTICE

This signal word draws attention to a potentially hazardous situation which, if not avoided, may result in property damage.



INFORMATION

Information draws attention to useful tips and suggestions, as well as information on efficient, error-free use.

1.3 Limitation of Liability

- The product has been developed in consideration of the current state-of-the-art technology, as well as applicable standards and guidelines. Subject to change without notice.
- A valid declaration of conformity can be accessed at www.wenglor.com in the product's separate download area.
- wenglor sensoric elektronische Geräte GmbH (hereinafter referred to as "wenglor") excludes all liability in the event of:
 - Non-compliance with the instructions
 - Use of the product for purposes other than those intended.
 - Use by untrained personnel.
 - Use of unapproved spare parts.
 - Unapproved modification of products.
- These operating instructions do not include any guarantees from wenglor with regard to the described procedures or specific product characteristics.
- wenglor assumes no liability for printing errors or other inaccuracies contained in these operating instructions unless wenglor was verifiably aware of such errors at the point in time at which the operating instructions were prepared.

1.4 Copyrights

- The contents of these instructions are protected by copyright law.
- All rights are reserved by wenglor.
- Commercial reproduction or any other commercial use of the provided content and information, in particular graphics and images, is not permitted without previous written consent from wenglor.

2 For Your Safety

2.1 Use for Intended Purpose

Contrast sensors detect the finest contrast differences on a wide range of materials and surfaces. Print marks can be detected against any background, regardless of brightness or color values, and objects can be detected based on their contrast differences. Highest contrast resolutions are generated by long-life white light LED or red laser light.

This product can be used in the following industry sectors:

- Special-purpose mechanical engineering
- Heavy mechanical engineering
- Logistics
- Automotive industry
- Food industry
- Packaging industry
- Pharmaceuticals industry
- Plastics industry
- Woodworking industry
- Consumer goods industry
- Paper industry
- Electronics industry
- Glass industry
- Steel industry
- Aviation industry
- Chemicals industry
- Alternative energies
- Raw materials extraction

2.2 Use for Other than the Intended Purpose

- Not a safety component in accordance with 2006/42/EC (Machinery Directive).
- The product is not suitable for use in potentially explosive atmospheres.
- The product may be used only with accessories supplied or approved by wenglor, or in combination with approved products. A list of approved accessories and combination products can be found at www.wenglor.com on the product detail page.



DANGER

Risk of personal injury or property damage in case of use for other than the intended purpose!

Use for other than the intended purpose may lead to hazardous situations.

→ Observe instructions regarding use for intended purpose.

2.3 Personnel Qualifications

- Suitable technical training is a prerequisite.
- In-house electronics training is required.
- Trained personnel who use the product must have (permanent) access to the operating instructions.



DANGER

Risk of personal injury or property damage in case of incorrect initial start-up and maintenance!

Personal injury and damage to equipment may occur.

→ Adequate training and qualification of personnel

2.4 Modification of Products



DANGER

Risk of personal injury or property damage if the product is modified!

Personal injury and damage to equipment may occur. Noncompliance may result in loss of the CE mark and voiding of the warranty.

→ Modification of the product is not permitted

2.5 General Safety Precautions



INFORMATION

These instructions are an integral part of the product and must be kept on hand for the entire duration of its service life.

In the event of possible changes, the current version of the operating instructions can be found at www.wenglor.com in the product's separate download area.

Read the operating instructions carefully before using the product.

Protect the sensor against contamination and mechanical influences.

2.6 Approvals and Protection Class

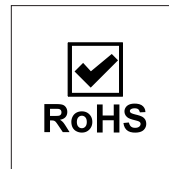
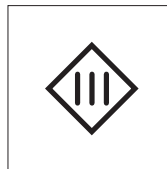
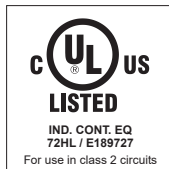

3 Technical Data

3.1 General data

	P1PW005
Optical data	
Working Range	30...40 mm
Working Distance	35 mm
Resolution (Gray Scale)	100
Switching Hysteresis	< 1 %
Light Source	White Light
Wavelength	400...700 nm
Service Life (T = +25 °C)	100000 h
Max. Ambient Light	10000 Lux
Light Spot Diameter	1.1 × 3.5 mm
Electrical data	
Supply Voltage	18...30 V
Current Consumption (U _b = 24 V)	< 50 mA
Switching Frequency	50 kHz
Response Time	13 µs
Jitter	5 µs
Temperature Drift	< 6 %
Temperature Range	-25...60 °C
Switching Output Voltage Drop	1.5 V
Switching Output/Switching Current	100 mA
Short Circuit Protection	yes
Reverse Polarity Protection	yes
Lockable	yes
Mode of operation	Color
Interface	IO-Link V1.1
Protection Class	III
IO-Link Version	1.1
Mechanical data	
Setting Method	Teach-In
Housing Material	Plastic, ABS
Optic Cover	Plastic, PMMA
Degree of Protection	IP67
Connection	M12 × 1; 5-pin
Connection 1	
Safety technology data	
MTTFd (EN ISO 13849-1)	719.27 a
Output functions	
PNP NC, PNP NO	yes
NPN NC, NPN NO	
External teach-in input	yes
Adjustable parameters	
Other parameters	Off-delay On-delay

3.2 Housing Dimensions

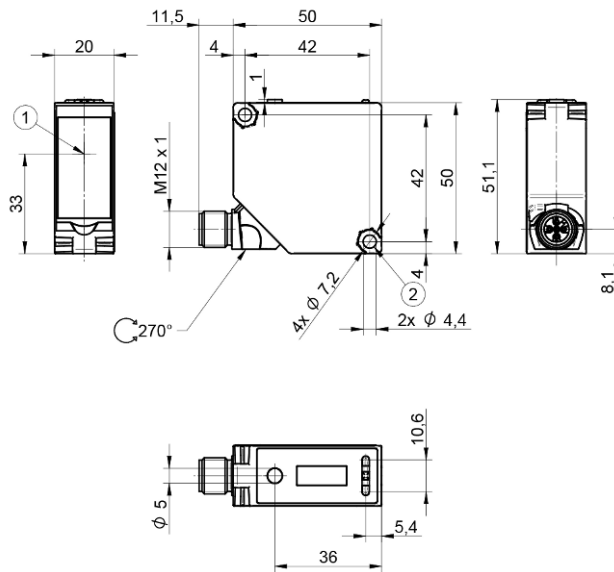

① = optical axis

Dimensions specified in mm (1 mm = 0.03937 Inch)

3.3 Control Panel

X9

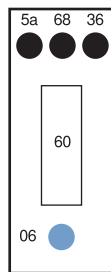

5a = switching status display, O1

06 = teach-in key

60 = display

68 = supply voltage indicator

36 = mode display

3.4 Complementary Products

wenglor offers you the right connection and mounting technology as well as other accessories for your product. You can find this at www.wenglor.com on the product details page at the bottom.

3.5 Scope of delivery

- Sensor
- Safety precaution
- BEF-SET-14 screws
- Z1PE002 spacer sleeves

4 Transport and Storage

4.1 Transport

Upon receipt of shipment, the goods must be inspected for damage in transit. In the case of damage, conditionally accept the package and notify the manufacturer of the damage. Then return the device, making reference to damage in transit.

4.2 Storage

The following points must be taken into consideration with regard to storage:

- Do not store the product outdoors.
- Store the product in a dry, dust-free place.
- Protect the product against mechanical impacts.
- Protect the product against exposure to direct sunlight.



NOTICE

Risk of property damage in case of improper storage!

The product may be damaged.

→ Storage instructions must be complied with.

5 Installation and Electrical Connection

5.1 Installation

- Protect the product from contamination during installation.
- Observe all applicable electrical and mechanical regulations, standards and safety rules.
- Protect the product against mechanical influences.
- Make sure that the sensor is mounted in a mechanically secure fashion.
- Specified torque values must be complied with (see section Technical Data [► 8]).
- Insert the supplied spacer sleeves into the designated recesses on the side facing the mounting surface.
- Install the sensor by means of the mounting hole with M4 screws (included in the scope of delivery).
- Do not exceed the maximum tightening torque of 0.5 Nm.



NOTICE

Risk of property damage in case of improper installation!

The product may be damaged!

→ Comply with installation instructions.



CAUTION

Risk of personal injury or property damage during installation!

Personal injury and damage to the product may occur.

→ Ensure a safe installation environment.

5.2 Adjustment

When adjusting sensors, note the following instructions so that the most stable object detection can be achieved:

- Adjust the sensor at the working distance so that a sharp image of the light spot is created.
- The sensor is aligned parallel to the print mark.
- For glossy surfaces, the sensor should be aligned at an angle of approx. 10° to the surface.



5.3 Electrical Connection

- Wire the sensor in accordance with the connection diagram.
- Switch on the supply voltage (see section Technical Data [► 8]).
- Connect the sensor to 18...30 V DC.



⚠ DANGER

Risk of personal injury or property damage due to electric current.

Voltage-conducting parts may cause personal injury or damage to equipment.

→ The electric device may be connected by appropriately qualified personnel only.

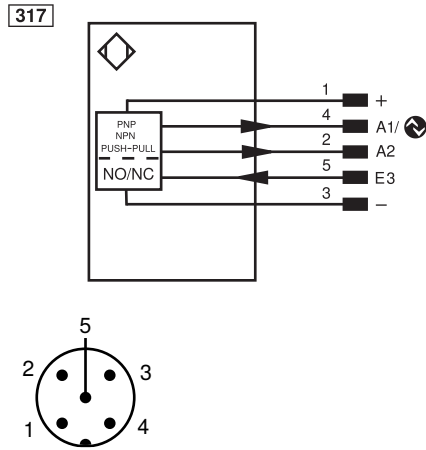

1	brown	2	white
3	blue	4	black
5	gray		

Legend

+	Supply Voltage +	PT	Platinum measuring resistor	ENAR5422	Encoder A/ \bar{A} (TTL)
-	Supply Voltage 0 V	nc	not connected	ENBR5422	Encoder B/ \bar{B} (TTL)
~	Supply Voltage (AC Voltage)	U	Test Input	ENA	Encoder A
A	Switching Output (NO)	\bar{U}	Test Input inverted	ENb	Encoder B
\bar{A}	Switching Output (NC)	W	Trigger Input	AMIN	Digital output MIN
V	Contamination/Error Output (NO)	W-	Ground for the Trigger Input	AMAX	Digital output MAX
\bar{V}	Contamination/Error Output (NC)	O	Analog Output	AOK	Digital output OK
E	Input (analog or digital)	O-	Ground for the Analog Output	SY In	Synchronization In
T	Teach Input	BZ	Block Discharge	SY OUT	Synchronization OUT
Z	Time Delay (activation)	AW	Valve Output	OLT	Brightness output
S	Shielding	a	Valve Control Output +	M	Maintenance
RxD	Interface Receive Path	b	Valve Control Output 0 V	rsv	reserved
TxD	Interface Send Path	SY	Synchronization	Wire Colors according to IEC 60757	
RDY	Ready	SY-	Ground for the Synchronization	BK	Black
GND	Ground	E+	Receiver-Line	BN	Brown
CL	Clock	S+	Emitter-Line	RD	Red
E/A	Output/Input programmable	\pm	Grounding	OG	Orange
	IO-Link	SnR	Switching Distance Reduction	YE	Yellow
PoE	Power over Ethernet	Rx+/-	Ethernet Receive Path	GN	Green
IN	Safety Input	Tx+/-	Ethernet Send Path	BU	Blue
QSSD	Safety Output	BuS	Interfaces-Bus A(+)/B(-)	VT	Violet
Signal	Signal Output	La	Emitted Light disengageable	GY	Grey
BI_D+/-	Ethernet Gigabit bidirect. data line (A-D)	Mag	Magnet activation	WH	White
EN0 r5422	Encoder 0-pulse 0- $\bar{0}$ (TTL)	RES	Input confirmation	PK	Pink
		EDM	Contacting Monitoring	GNYE	Green/Yellow

5.4 Diagnosis

display	Status	Meaning
Power LED		sensor ready
P		No voltage supply available
		Warning The LEDs for switching status indicator A1 and A2 remain in operation

display	Status	Meaning
		Error The LEDs for switching status indicator A1 and A2 are not functioning
Switching status indicator A1		Switching output active
		Switching output not active
Mode indicator	x 1	Sensor in print marks mode
	x 2	sensor in contrast mode
	x 3	sensor in color mode
Localization		Localization function active

- = not lit
- = permanently lit
- = flashing

5.5 LED Bar Display

The LED bar display shows the quality of the signal during the current process. The 9 LEDs visualize how close the current signal of the detected object is to the taught-in signal. In the non-switched state, the display of the last detected object is maintained.

<ul style="list-style-type: none"> • Signal close to taught-in signal • Stable detection 	<ul style="list-style-type: none"> • Signal reduced to taught-in signal • Detection still possible • New teach-in recommended 	<ul style="list-style-type: none"> • Signal too far away from the taught-in signal • Detection not possible • New teach-in required

5.6 Troubleshooting

Error	Possible cause	Remedy
Warning	Signal warning	<ul style="list-style-type: none"> • Reduce distance between sensor and object • Adjust angle between sensor and object • Remove contamination
	Undervoltage	<ul style="list-style-type: none"> • Increase voltage supply to at least 18 V DC
	Temperature too high	<ul style="list-style-type: none"> • Mount mounting bracket as cooling plate • Reduce load on outputs
Error	Short circuit	<ul style="list-style-type: none"> • Check the electrical wiring and eliminate the short circuit

Error	Possible cause	Remedy
	Temperature error	<ul style="list-style-type: none"> • Disconnect the sensor from the supply voltage and allow it to cool • Mount the mounting bracket as a heat sink • Reduce load on outputs
	Device error	<ul style="list-style-type: none"> • Disconnect the sensor from the supply voltage and restart it • Replace the sensor



INFORMATION

Behavior in case of error:

1. Shut down the machine.
2. Analyze and rectify the cause of the error using the diagnostic information.
3. If the error cannot be rectified, contact wenglor support.
4. Do not operate the machine if the error behavior is unclear.
5. The machine must be taken out of service if the error cannot be clearly identified or reliably rectified.



DANGER

Risk of personal injury or property damage if not observed!

The safety function of the system is disabled. Damage to personnel and equipment.

→ Behavior in case of error as specified.

6 Settings

The sensor can be set via external teach-in, IO-Link and wTeach2. The different setting options are outlined below.

Three different operating modes are available to optimally adapt the sensor to the relevant application. Separate versions with preset operating modes are available.

6.1 Configuration with Push of Button / Teach-In

This section describes the settings that can be configured directly on the sensor using the button.

The teach-in procedure differs depending on the set mode of operation. Further teach modes are available via IO-Link.

6.1.1 Teach-in in Print Mark Mode of Operation

6.1.1.1 2-Point-Teach

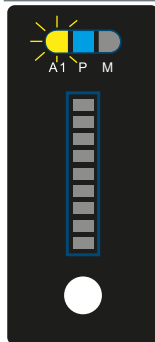

1. Press and hold the Teach-in key for 2 seconds until LED A1 starts to flash.
2. Release the button. LED will continue blinking.
3. Position the object so that the light spot hits the print or contrast markings to be taught in.
4. Briefly press the Teach-in key. The transmit LED sets the optimal light intensity.
5. Place the object so that the light spot hits the background.
6. Briefly press the Teach-in key. The transmit LED sets the optimal light intensity.
7. The print or contrast marking is taught in, and LED A1 flashes briefly twice to confirm successful teach-in.
8. The teach-in quality is then displayed on the bar display.

Display of the teach-in quality via the LED bar display.

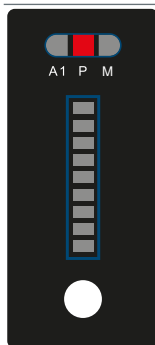

If the contrast difference is too small so that teach-in is not possible, all LEDs of the bar display are off and the power LED lights up red.

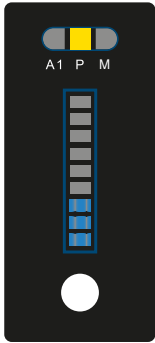
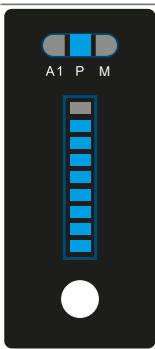
	<p>If there is a weak contrast difference, the lower LEDs of the bar display flash and the power LED lights up yellow.</p>
	<p>If the contrast difference is good, more LEDs on the bar display light up and the better the contrast difference. The power LED lights up blue.</p>

6.1.1.2 Dynamic Teach

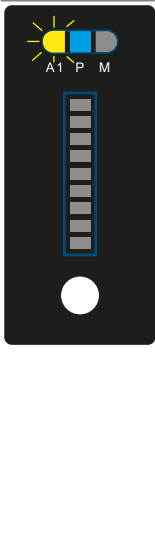
	<ol style="list-style-type: none"> 1. Press and hold the Teach-in key for 5 seconds until LED A1 starts to flash rapidly. Release the button. LED will continue blinking. 2. Release the button. LED will continue blinking. 3. The sensor is switched to recording mode operation allowing for automatic teach-in. 4. Present so that the light spot hits alternating the mark and the background. 5. Briefly press the Teach-in key or proceed for max. 60 sec. The transmit LED sets the optimal light intensity. 6. The print or contrast marking is taught in, and LED A1 flashes briefly twice to confirm successful teach-in. 7. The teach-in quality is then displayed on the bar display.
--	---

Display of the teach-in quality via the LED bar display

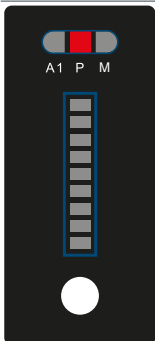
	<p>If the contrast difference is too small so that teach-in is not possible, all LEDs of the bar display are off and the power LED lights up red.</p>
---	---

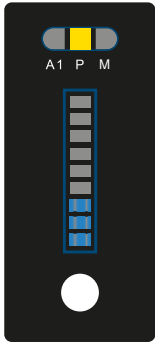
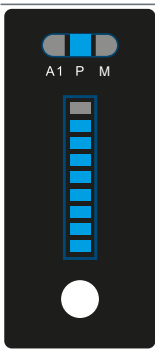
	<p>If there is a weak contrast difference, the lower LEDs of the bar display flash and the power LED lights up yellow.</p>
	<p>If the contrast difference is good, more LEDs on the bar display light up and the better the contrast difference. The power LED lights up blue.</p>

6.1.2 Teach-In in Contrast Mode of Operation

In this mode, a teach window is used.

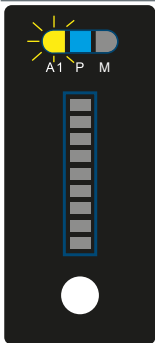
	<ol style="list-style-type: none"> 1. Adjust the sensor so that the light spot strikes the object to be taught in. 2. Press and hold the Teach-in key for 2 seconds until LED A1 starts to flash. 3. Release the Teach-in key. 4. The current contrast distance is taught in, and LED A1 flashes briefly twice to confirm successful teach-in. 5. The teach-in quality is then displayed via the bar display
---	---

Display of the teach-in quality via the LED bar display

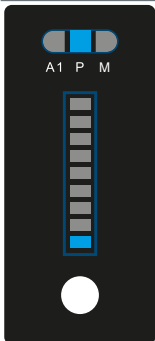
	<p>A very low contrast value has been taught in, e.g. a black object. The power LED lights up blue.</p>
---	---

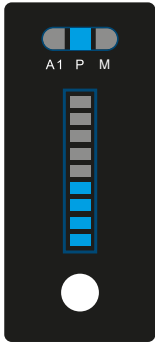
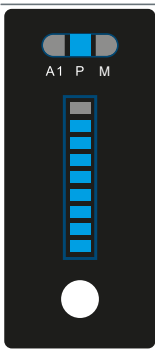
	<p>A low contrast value has been taught in, e.g. dark object. The power LED lights up blue.</p>
	<p>A high contrast difference between the mark and background has been taught in. The power LED lights up blue.</p>

6.1.3 Teach-In in Color Mode of Operation

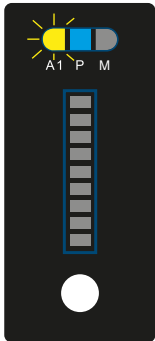
	<ol style="list-style-type: none"> 1. Adjust the sensor so that the light spot strikes the object to be taught in. 2. Press and hold the Teach-in key for 2 seconds until LED A1 starts to flash. 3. Release the Teach-in key. 4. The current color value is taught in, and LED A1 flashes briefly twice to confirm successful teach-in. 5. The teach-in quality is then displayed via the bar display
--	---

Display of the teach-in quality via the LED bar display

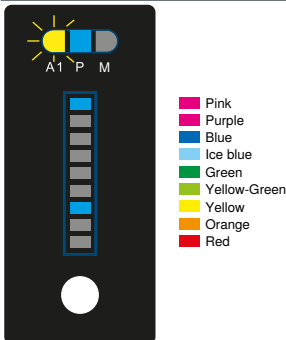
	<p>The taught-in color value is displayed. Each of the 9 LEDs is assigned a color value. The power LED lights up blue.</p>
---	--

6.2 Operating Modes

6.2.1 Display the Mode of Operation

Briefly press the Teach-in key. The set mode is indicated by the LED M:

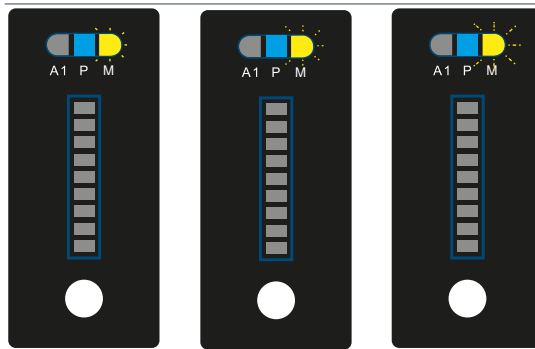

LED M flashes 1 time: print mark mode of operation
 LED M flashes 2 times: contrast mode of operation
 LED M flashes 3 times: color mode of operation

6.2.2 Print Marks Mode

Mode of Operation

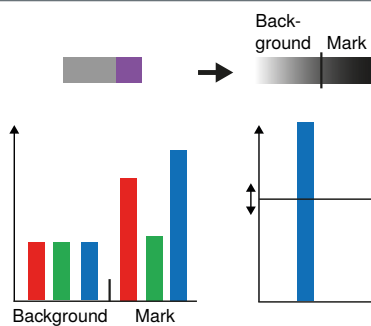

Example: gray background, purple contrast marking

- The sensor evaluates the RGB signals from the contrast marking and the background.
- For the evaluation, select the channel for which there is the greatest signal difference between the mark and the background (in the example on the left, the blue channel).
- From now on, the contrast value of the selected channel will be evaluated in order to distinguish between the mark and background.

Areas of Use

Detect colored contrast markings on a constant background

6.2.3 Contrast Mode

Mode of Operation

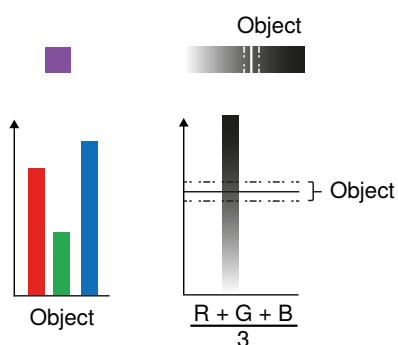

Example: Purple object

- The sensor evaluates the RGB signals from the object.
- An average contrast value is formed from the individual RGB signals and taught in as a window.
- This is now used to detect contrasts.

Areas of Use

- Detection of black contrast markings on patterned backgrounds
- Detection of objects based on the contrast value

6.2.4 Color Mode

Mode of Operation

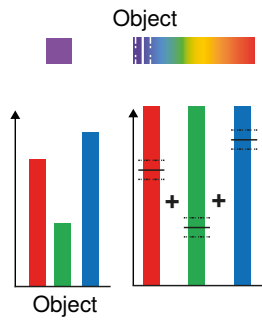

Example: Purple object

- The sensor evaluates the RGB signals from the object.
- A color value is formed from the individual signals and taught in as a window.
- This is now used to identify colors.

Areas of Use

- Detection of contrast markings on a background with similar contrast but different colors
- Identification and sorting of objects by color

6.3 Setting the Operating Mode

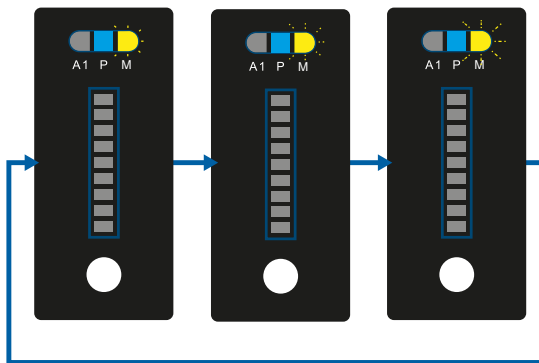

Press and hold the Teach-in key for 8 seconds until LED M starts to flash and LED A1 is off.

The various operating modes are displayed in coded form via an extended flashing menu:

- LED flashes 1 time: print mark mode of operation
- LED flashes 2 times: contrast mode of operation
- LED flashes 3 times: color mode of operation

You can switch between the operating modes by pressing the button briefly.

If the button is not pressed for 10 seconds, the menu is exited and the setting is applied.

7 IO-Link

7.1 Settings via IO-Link/Parameters

7.1.1 Sensor Functions

Function	Possible settings	Default
Localization	<p>The sensor LEDs A1 and M can be switched to flashing. This allows the sensor to be easily located in a plant.</p> <p>On LEDs A1 and M flash.</p> <p>Off LEDs in normal function.</p>	Off
Key disabling	<p>The teach-in key can be locked to protect the sensor against accidental adjustment.</p> <p>Unlocked Operation possible via the teach-in key</p> <p>Locked Operation via teach-in key not possible</p>	Unlocked
Active memory space	<p>Up to 10 sets of parameters for the sensor functions and the switching point functions can be saved.</p> <p>Changed parameters are saved in the active memory space. If a new memory space is selected, the parameters will be saved there from now on.</p> <p>Space 0...9</p>	0
Name of memory space	<p>Each of the 10 memory spaces can be given a unique name.</p>	***
Mode of operation	<p>3 different operating modes are available. These are described in more detail in section Operating Modes [► 19].</p> <p>Print mark</p> <p>Contrast</p> <p>Color</p>	Color
Emitted light	<p>The transmit LED of the sensor can be switched on or off.</p> <p>On Transmit LED on</p> <p>Off Transmit LED off</p> <p>The sensor no longer supplies a measured value.</p> <p>Note!</p> <ul style="list-style-type: none">If the emitted light LED is switched off, the sensor behavior corresponds to the status "No signal."	On
Filter	<p>The interference filter can be used to increase measurement reliability in the event of temporary interference. A higher filter level allows the interfering signals to be ignored. If changes happen suddenly, the response time is extended. This extension of the response time depends on the filter level and the mode used. The maximum switching frequency can be reached only with minimum filter selection</p> <p>Minimum</p> <p>Medium</p>	Minimum

Function	Possible settings	Default
	Maximum	
Hysteresis	The hysteresis is the difference between the switch-on and switch-off point and can be set in 3 stages. Minimum Medium Maximum	Medium

7.1.2 Input/Output Functions (E/A)

7.1.2.1 Pin Function

The pin function is used to define the function of pins A1, A2 and E3, as these can be used for different functions.

Function	Possible settings	Defaults
A1	Switching Output Switching point SSC1 is assigned to the switching output. Error Output The error output switches if one of the assigned errors occurs; see table Status Message Function [► 26] Warning Output The warning output switches if one of the assigned warnings occurs; see table Status Message Function [► 26] Deactivated The pin is deactivated.	Switching output
A2	Error Output The error output switches if one of the assigned errors occurs; see table Status Message Function [► 26] Warning Output The warning output switches if one of the assigned warnings occurs; see table Status Message Function [► 26] Antivalent Switching Output The switching output switches antivalently to switching output A1. Deactivated The pin is deactivated.	Antivalent switching output
E3	Teach-In Input Teach-in The output can be set by following the same procedure as with the Teach-in key (see section 6). An activated input corresponds to a depressed Teach-in key. Locking If 18...30 V DC is continuously applied to the teach-in input, the Teach-in key is locked and protected to prevent unintentional changes, like the input signal. Trigger Input In trigger mode, a switching process is triggered only by an edge (change of an electrical signal from minus to plus or vice versa) on the trigger input Deactivated	Teach-in input

Function	Possible settings	Defaults
	The pin is deactivated	

7.1.2.2 Output Functions

The output functions are used to set the physical outputs.

Function	Possible settings	Default
PNP/NPN/push-pull	<p>PNP</p> <p>The load or analysis module is connected between the negative pole (reference) and the output. When the sensor switches, the output is connected to the positive pole via an electronic switch. The switching signal is maintained when a pull-down resistor is connected.</p> <p>NPN</p> <p>The load or the analysis module is connected between the positive pole (reference) and the output. When the sensor switches, the output is connected to the negative pole via an electronic switch. The switching signal is maintained when a pull-up resistor is connected.</p> <p>push-pull</p> <p>PNP and NPN are switched alternately.</p>	PNP
Normally closed/normally open	<p>NO</p> <p>Light switching (normally open)</p> <p>The output is closed when the condition has been met, depending on the setting (switching point, warning, error).</p> <p>NC</p> <p>Dark switching</p> <p>The output is open when the condition has been met, depending on the setting (switching point, warning, error).</p>	NO
On-delay	0...10,000 ms	0 ms
Off-delay	0...10,000 ms	0 ms
Impulse	0...10,000 ms	0 ms

7.1.2.3 Input Functions

The input functions are used to set the physical inputs.

Function	Possible settings	Default
Input mode	<p>Supply Voltage Active</p> <p>Function is triggered as soon as supply voltage is applied to the input.</p> <p>Supply Voltage Inactive</p> <p>Function is triggered as soon as 0 V is applied to the input or the input is opened.</p>	Supply voltage active

7.1.3 Switching Point Functions (SSC1)

The switching point functions are used to set the switching point. This is assigned to output A1.

Function	Possible settings	Default
Teach-in	Starts the teach-in process.	
Teach-in mode	<p>Two-Point Teach-In</p> <p>This mode is used in print mark mode of operation. The mark is taught in first, then the background.</p>	Window Teach-In

Function	Possible settings	Default
	<p>Dynamic Teach-In</p> <p>This mode is used in print mark mode of operation. A print mark is automatically taught in by the sensor</p> <p>Window Teach-In</p> <p>This mode is used in contrast and color mode of operation. In contrast mode of operation, a window is placed around the taught-in average contrast value of the 3 channels.</p> <p>In color mode of operation, a separate window is placed around the respective contrast value of the channel for each color channel.</p> <p>Jump Detection</p> <p>This mode is used in print mark and contrast mode of operation.</p> <p>There is no switch to an absolute measured value, but rather to a measured value jump occurring between 2 measurements.</p>	
Configuration mode	The following parameters are taught in automatically during a teach-in. In this case, the configuration mode is set to Auto. The parameters can also be adjusted manually. In this case, the configuration mode changes to Manual.	Auto
Switching point	The switching point corresponds to the switching threshold of the contrast value and is defined in digits. 0...1023	
Sensitivity	In teach-in mode, two-point teach-in (print mark) The sensitivity defines how close the switching point is to the signal of the print-mark. For example, if there is a difference of 500 between the background and the mark, 10% sensitivity corresponds to 50. So the switching point is 50 digits above the signal of the print-mark. 5...90%	20%
Active RGB channel	In print mark mode of operation, one of the 3 color channels is used to distinguish the contrast marking from the background. Red Green Blue	Green
Mark type	Dark Dark contrast marking on light background Bright Bright contrast marking on dark background	Dark
Window size	In teach-in mode window (contrast) 2...50%	10%
Switching point red	In teach-in mode window (color) 0...1023	150
Switching point green	In teach-in mode window (color) 0...1023	150
Switching point blue	In teach-in mode window (color) 0...1023	150
Window size red	In teach-in mode window (color)	10%

Function	Possible settings	Default
	2...50%	
Window width green	In teach-in mode window (color) 2...50%	10%
Window width blue	In teach-in mode window (color) 2...50%	10%
Jump height min	In teach-in mode, jump detection The min. jump height specifies the measured value jump from which a jump event should be detected. 20...1500	50
Jump direction	In Teach-in mode, jump detection Positive A jump is detected when the measured value jumps to a higher value, i.e. the contrast value becomes brighter. Negative A jump is detected when the measured value jumps to a lower value, i.e. the contrast value becomes darker. Both A jump is detected for both positive and negative.	Negative
Cycle offset	In teach-in mode, jump detection The cycle offset indicates which time-shifted reference measured value to use for comparison with the current measured value in order to detect the jump. 10...20000 cycles	1000
Jump pulse duration	In teach-in mode, jump detection 0 = hold The output remains active until the next jump in the opposite direction has been detected. 1...10,000 ms If a jump is detected, the output is activated with the corresponding pulse length.	0
Maximum detected jump height	The maximum detected signal jump is shown in digits in order to make it easier to set the jump height. The maximum measurement can be reset in order to read a new maximum.	

7.1.4 Condition Monitoring/Process Data

The data described in the following section can be read or written cyclically via IO-Link/process data.

7.1.4.1 Status Message Function

The sensor provides various status messages. Due to the process data structure, four status messages can be transmitted as individual process data.

These parameters can be used to set the status messages that are transmitted via the process data.

7.1.4.2 Warning/Error Output Function

The status messages used to trigger the collective message can be defined for the warning output and the error output respectively. The status messages are OR-linked so that the output is activated when one of the defined status messages is activated.

Function	Possible settings	Default
Warning output	See table "Status Messages"	Signal warning, optics dirty, ambient light, temperature too high, temperature too low, undervoltage, interference in the working range
Error output	See table "Status Messages"	Object too close, object too far, no signal, device error, over-temperature, short circuit

Status Messages

Warning	
Undervoltage	The supply voltage is too low.
Contaminated Optics	The sensor detects when the optic cover is dirty, and the signal deteriorates as a result
Temperature too low	The sensor's internal temperature is low.
Temperature too high	The sensor's internal temperature is high.

Error	
Short circuit	A short circuit has occurred on at least one pin.
Temperature error	Temperature is outside permissible range. To protect the emitting unit, the laser is switched off.
Device error	A hardware error has occurred. For safety reasons, the laser is switched off.

7.1.4.3 Simulation Functions

This function simulates the behavior of the sensor regardless of the current status and measured value. This can be used to check whether a plant in which the sensor is integrated reacts correctly to the data supplied by the sensor and processes them accordingly.

If a measured value is specified, the sensor behaves as if the specified measured value corresponds to the actual measured value. This means that the behavior of the outputs and status messages is simulated according to the specified measured value.

In addition, the individual outputs and status messages can be simulated separately from the measured value.



INFORMATION

Output A1 is used for IO-Link communication in this function and cannot be simulated.

Simulation mode ends automatically as soon as the power supply is interrupted.

Function	Possible settings	Default
Simulation mode	On Off	Off
Test signal value	Current signal value 0...1023	Current measured value
SSC1 Test	According to the measured value On Off	According to measured value
Status messages test	Tests the individual status messages according to the measured value	According to measured value

Function	Possible settings	Default
	On Off	

8 Maintenance Instructions



NOTICE

This wenglor sensor is maintenance-free.

Cleaning and inspection of the plug connections at regular intervals are advisable.

Do not clean the sensor with solvents or cleaning agents that could damage the product.

The product must be protected against contamination during initial start-up.

9 Proper Disposal

wenglor sensoric GmbH does not accept the return of unusable or irreparable products. Respectively valid national waste disposal regulations apply to product disposal.

10 **Declarations of Conformity**

Declarations of conformity can be found on our website at www.wenglor.com in the product's separate download area.