

Operating Instructions

U18T001

Distance Sensor



EN



Table of Contents

1	General	4
1.1	Information Concerning these Instructions	4
1.2	Explanation of Symbols	4
1.3	Limitation of Liability	5
1.4	Copyrights	5
2	For Your Safety	6
2.1	Use for Intended Purpose	6
2.2	Use for Other than the Intended Purpose	6
2.3	Personnel Qualifications	6
2.4	Modification of Products	7
2.5	General Safety Precautions	7
2.6	Approvals and Protection Class	7
3	Technical Data	8
3.1	General Data	8
3.2	Default Settings	8
3.3	Warm-Up Phase	9
3.4	Mode-Dependent Data	9
3.5	Sonic Cone Diagrams	10
3.6	Housing Dimensions	11
3.7	Control Panel	11
3.8	Complementary Products	12
3.9	Scope of delivery	12
4	Transport and Storage	13
4.1	Transport	13
4.2	Storage	13
5	Installation and Electrical Connection	14
5.1	Installation	14
5.2	Electrical Connection	14
6	Diagnosis	16
6.1	LED Indicators	16
6.2	Troubleshooting	16
7	Settings	18
7.1	Sensor Settings	18
7.1.1	Foreground Teach-In	18
7.1.2	Background Teach-In	18
7.2	Setting via IO-Link and wTeach2	19
7.2.1	Window teach-in	19
7.2.2	Through-Beam Sensor Operating Mode	19
7.2.3	Synchronous Mode of Operation	20
7.2.4	Multiplex Mode	20
7.2.5	Analog Output	21
7.2.6	Additional Functions and Settings	21
7.2.7	Condition Monitoring Functions	24
7.2.8	Condition Monitoring/Process Data	25
7.3	Pin Functions	26
7.3.1	Input Functions	26

7.3.2 Output Functions.....	27
8 Maintenance Instructions	28
9 Proper Disposal	29
10 Declarations of Conformity.....	30

1 General

1.1 Information Concerning these Instructions

- These instructions make it possible to use the product safely and efficiently.
- These instructions are an integral part of the product and must be kept on hand for the entire duration of its service life.
- Local accident prevention regulations and national work safety regulations must be complied with as well.
- The product is subject to further technical development, and thus the information contained in these operating instructions may also be subject to change. The current version can be found at www.wenglor.com in the product's separate download area.



INFORMATION

The operating instructions must be read carefully before using the product and must be kept on hand for later reference.

1.2 Explanation of Symbols

- Safety precautions and warnings are emphasized by means of symbols and signal words.
- Safe use of the product is only possible if these safety precautions and warnings are adhered to.

The safety precautions and warnings are laid out in accordance with the following principle:

SIGNAL WORD

Type and source of danger!

Possible consequences in the event that the hazard is disregarded.

→ Measures for averting the hazard.

The meanings of the signal words, as well as the scope of the associated hazards, are listed below:



! DANGER

This signal word indicates a hazard with a high degree of risk which, if not avoided, results in death or severe injury.



! WARNING

This signal word indicates a hazard with a medium degree of risk which, if not avoided, may result in death or severe injury.



! CAUTION

This signal word indicates a hazard with a low degree of risk which, if not avoided, may result in minor or moderate injury.



NOTICE

This signal word draws attention to a potentially hazardous situation which, if not avoided, may result in property damage.



INFORMATION

Information draws attention to useful tips and suggestions, as well as information on efficient, error-free use.

1.3 Limitation of Liability

- The product has been developed in consideration of the current state-of-the-art technology, as well as applicable standards and guidelines. Subject to change without notice.
- A valid declaration of conformity can be accessed at www.wenglor.com in the product's separate download area.
- wenglor sensoric elektronische Geräte GmbH (hereinafter referred to as "wenglor") excludes all liability in the event of:
 - Non-compliance with the instructions
 - Use of the product for purposes other than those intended.
 - Use by untrained personnel.
 - Use of unapproved spare parts.
 - Unapproved modification of products.
- These operating instructions do not include any guarantees from wenglor with regard to the described procedures or specific product characteristics.
- wenglor assumes no liability for printing errors or other inaccuracies contained in these operating instructions unless wenglor was verifiably aware of such errors at the point in time at which the operating instructions were prepared.

1.4 Copyrights

- The contents of these instructions are protected by copyright law.
- All rights are reserved by wenglor.
- Commercial reproduction or any other commercial use of the provided content and information, in particular graphics and images, is not permitted without previous written consent from wenglor.

2 For Your Safety

2.1 Use for Intended Purpose

Ultrasonic sensors emit pulsed ultrasonic waves at a certain frequency using air as a transmitting medium. Parameters can be taught into the sensors shown here via an input or IO-Link. The output is switched when the preselected switching point is reached. With some variants, the measured values can be output as an analog value. In addition, the measured value can be read out via IO-Link 1.1. The sensors can be used in both reflex mode and through-beam mode.

This Product Can Be Used in the Following Industry Sectors:

- Special-purpose mechanical engineering
- Heavy mechanical engineering
- Logistics
- Automotive industry
- Food industry
- Packaging industry
- Pharmaceuticals industry
- Plastics industry
- Woodworking industry
- Consumer goods industry
- Paper industry
- Electronics industry
- Glass industry
- Steel industry
- Aviation industry
- Chemicals industry
- Alternative energies
- Raw materials extraction

2.2 Use for Other than the Intended Purpose

- Not a safety component in accordance with 2006/42/EC (Machinery Directive).
- The product is not suitable for use in potentially explosive atmospheres.
- The product may be used only with accessories supplied or approved by wenglor, or in combination with approved products. A list of approved accessories and combination products can be found at www.wenglor.com on the product detail page.



DANGER

Risk of personal injury or property damage in case of use for other than the intended purpose!

Use for other than the intended purpose may lead to hazardous situations.

→ Observe instructions regarding use for intended purpose.

2.3 Personnel Qualifications

- Suitable technical training is a prerequisite.
- In-house electronics training is required.
- Trained personnel who use the product must have (permanent) access to the operating instructions.



DANGER

Risk of personal injury or property damage in case of incorrect initial start-up and maintenance!

Personal injury and damage to equipment may occur.

→ Adequate training and qualification of personnel

2.4 Modification of Products



DANGER

Risk of personal injury or property damage if the product is modified!

Personal injury and damage to equipment may occur. Noncompliance may result in loss of the CE and/or UKCA mark and voiding of the warranty.

→ Modification of the product is not permitted

2.5 General Safety Precautions



INFORMATION

These instructions are an integral part of the product and must be kept on hand for the entire duration of its service life.

In the event of possible changes, the current version of the operating instructions can be found at www.wenglor.com in the product's separate download area.

Read the operating instructions carefully before using the product.

Protect the sensor against contamination and mechanical influences.

2.6 Approvals and Protection Class

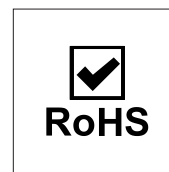
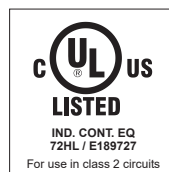

3 Technical Data

3.1 General Data

Ultrasound Data	
Working range, reflex sensor	50 ... 600 mm
Working range, through-beam sensor	1 ... 1200 mm
Setting Range	50 ... 600 mm
Reproducibility maximum	1 mm
Linearity Deviation	2 mm
Resolution	1 mm
Ultrasonic Frequency	300 kHz
Service Life (T = +25 °C)	100000 h
Switching Hysteresis	2 %
Electrical Data	
Supply Voltage	18 ... 30 V DC
Current Consumption (U _b = 24 V)	< 40 mA
Switching frequency, reflex sensor	9 Hz
Switching frequency, through-beam sensor	9 Hz
Response time, reflex sensor	56 ms
Response time, through-beam sensor	56 ms
Temperature Drift	< 10 %
Temperature Range	-30 ... 60 °C
Number of Switching Outputs	1
Switching Output Voltage Drop	< 2.5 V
Switching Output/Switching Current	100 mA
Analog Output	0...10 V
Synchronous Mode	Max. 32 sensors
Multiplex Mode	Max. 16 sensors
Short Circuit Protection	yes
Reverse Polarity Protection	yes
Interface	IO-Link V1.1 Smart Sensor Profile
Data Storage	yes
Protection Class	III
Mechanical Data	
Setting Method	Teach-in/IO-Link
Housing Material	Stainless steel, V2A (1.4305 / 303)
Sensing face	Epoxy resin/glass bubble mixture
Degree of Protection	IP67
Connection	M12 × 1; 4/5-pin

3.2 Default Settings

Technical specifications	
teach-in key	unlocked
Mode of operation	Synchron
Filter	0
Sonic cone	default
Process data type	Outputs and measurement value

Technical specifications	
Temperature mode	Internal
A1 Pin Function	Switching output
A2 Pin Function	-
O Analog output	Voltage output
A1 Teach Modue	Foreground
A1 PNP/ NPN	PNP
A2 PNP/ NPN	-
A1 NO/ NC	NO
A1 Switching point	600 mm
A1 Switching point near	-
A1 Swichting point far	-
A1 Additional hysteresis	0 mm
A2 Teach Mode	-
A2 NO/ NC	-
A2 Switing point	-
A2 Additional hysteresis	-
E3 pin Function	Synchronous input/output

3.3 Warm-Up Phase

The warm-up phase lasts roughly 30 minutes. At the beginning of the warm-up phase, linearity deviation and reproducibility may deviate from the specified values. During the warm-up phase, the values improve in the form of an exponential function until the values in the technical data are reached. The switch-on drift during this time is shown in the following diagram.

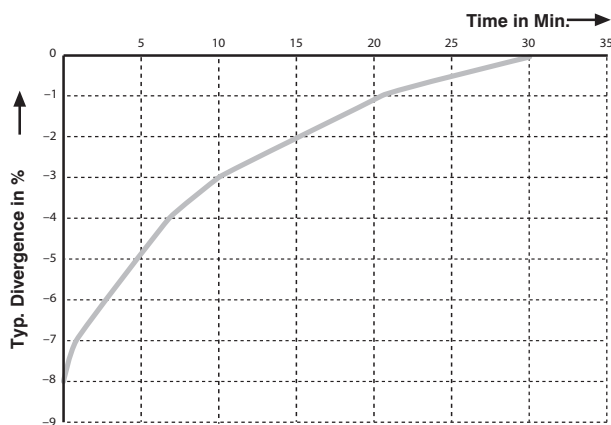

3.4 Mode-Dependent Data

Some technical data depend on the mode set. Depending on the setting, the following data are obtained:

Reflex and Through-Beam Mode

Filter value	Switching frequency in Hz	Response time in ms
0	9.0	56
1	6.8	74
2	5.4	93
3	4.5	111
4	3.9	130
5	3.4	148
6	3.0	167

Filter value	Switching frequency in Hz	Response time in ms
7	2.7	185
8	2.5	204
9	2.3	222
10	2.1	241
11	1.9	259
12	1.8	278
13	1.7	286
14	1.6	315
15	1.5	333
16*	1.4	352
17*	1.2	426
18*	1.0	500
19*	0.96	519
20*	0.96	519

* The specified switching frequency and response time correspond to the maximum duration including the interference filter. A detailed description of the filter function can be found in section Additional Functions and Settings [► 21].

3.5 Sonic Cone Diagrams

Measurement of the sonic cone on a 100 × 100 mm plate

Characteristic curves show the position of the center or the front edge of the measured object (100 × 100 mm plate) at the time of switching.

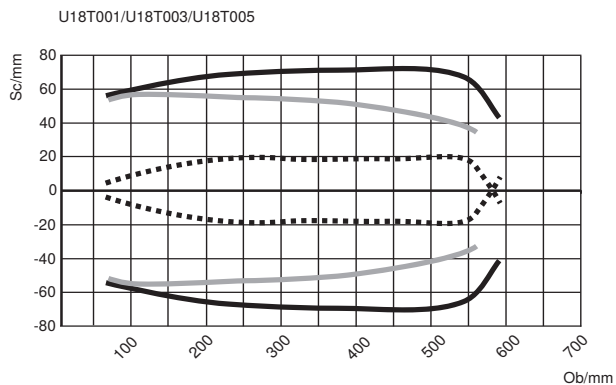

Measurement of the sonic cone on a rod with a diameter of 25 mm

Characteristic curves show the position of the center or the front edge of the measured object (Ø 25 mm rod) at the time of switching.

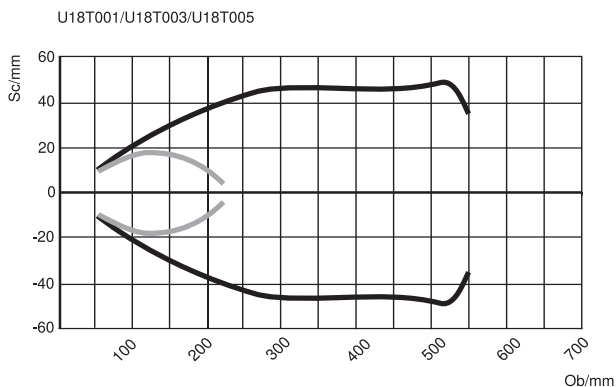

Ob = object

Sc = sonic cone

- Standard sonic cone (center of the measured object)
- Extra-narrow sonic cone (center of the measured object)
- Standard sonic cone (front edge of the measured object)



INFORMATION

Please note that using multiple ultrasonic sensors can cause reciprocal influence.

3.6 Housing Dimensions

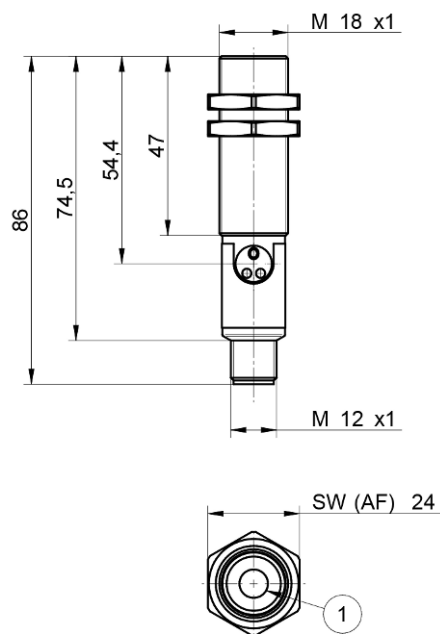

① = transducer

Dimensions in mm (1 mm = 0,03937 Inch)

3.7 Control Panel

D12

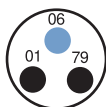

01 = switching status indicator

06 = teach-in key

79 = run/error indicator

3.8 Complementary Products

wenglor offers you the right connection and mounting technology as well as other accessories for your product. You can find this at www.wenglor.com on the product details page at the bottom.

3.9 Scope of delivery

- Sensor
- Safety precaution
- Mounting nuts

4 Transport and Storage

4.1 Transport

Upon receipt of shipment, the goods must be inspected for damage in transit. In the case of damage, conditionally accept the package and notify the manufacturer of the damage. Then return the device, making reference to damage in transit.

4.2 Storage

The following points must be taken into consideration with regard to storage:

- Do not store the product outdoors.
- Store the product in a dry, dust-free place.
- Protect the product against mechanical impacts.
- Protect the product against exposure to direct sunlight.



NOTICE

Risk of property damage in case of improper storage!

The product may be damaged.

→ Storage instructions must be complied with.

5 Installation and Electrical Connection

5.1 Installation

- If the object has smooth surfaces, the angle between the axis of the sound waves and the surface of the object should be $90^\circ \pm 3^\circ$. The angle can be considerably larger in the case of rough object surfaces.
- The active surface of the sensor may not contact any other machine parts.



INFORMATION

Observe the blind spot.

In the area between the sensor's active surface and the beginning of its working range, correct functioning of the sensor is not assured. No objects may be located in this area.



NOTICE

Risk of property damage in case of improper installation!

The product may be damaged!

→ Comply with installation instructions.



CAUTION

Risk of personal injury or property damage during installation!

Personal injury and damage to the product may occur.

→ Ensure a safe installation environment.

5.2 Electrical Connection

- Wire the sensor in accordance with the connection diagram.
- Switch on the supply voltage (see section Technical Data [► 8])
- If using IO-Link, connect the sensor to 18...30 V DC.
- If not using IO-Link, connect the sensor to 16...30 V DC.



DANGER

Risk of personal injury or property damage due to electric current.

Voltage-conducting parts may cause personal injury or damage to equipment.

→ The electric device may be connected by appropriately qualified personnel only.



CAUTION

Beware of excessive heat in case of a short circuit

Our sensors are short-circuit-proof. Nevertheless, the sensor housing may heat up in the event of a short circuit.

→ Pay attention to the polarity of the electrical connection

371

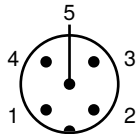
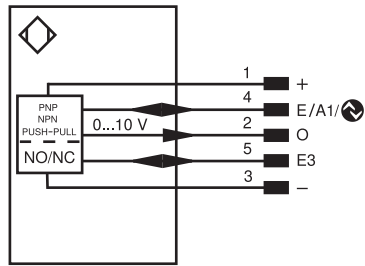







1	Brown	2	White
3	Blue	4	Black
5	Gray		

Legend					
+	Supply Voltage +	PT	Platinum measuring resistor	EN _{ANS422}	Encoder A/Ā (TTL)
-	Supply Voltage 0 V	nc	Not connected	EN _{BRS422}	Encoder B/B̄ (TTL)
~	Supply Voltage (AC Voltage)	U	Test Input	ENA	Encoder A
A	Switching Output (NO)	Ū	Test Input inverted	ENb	Encoder B
Ā	Switching Output (NC)	W	Trigger Input	AMIN	Digital output MIN
V	Contamination/Error Output (NO)	W-	Ground for the Trigger Input	AMAX	Digital output MAX
V̄	Contamination/Error Output (NC)	O	Analog Output	AOK	Digital output OK
E	Input (analog or digital)	O-	Ground for the Analog Output	SY In	Synchronization In
T	Teach Input	BZ	Block Discharge	SY OUT	Synchronization OUT
R	Reset input	AMv	Valve Output	OLT	Brightness output
Z	Time Delay (activation)	a	Valve Control Output +	M	Maintenance
S	Shielding	b	Valve Control Output 0 V	rsv	Reserved
RxD	Interface Receive Path	SY	Synchronization	Wire Colors according to DIN IEC 60757	
TxD	Interface Send Path	SY-	Ground for the Synchronization	BK	Black
RDY	Ready	E+	Receiver-Line	BN	Brown
GND	Ground	S+	Emitter-Line	RD	Red
CL	Clock	⊕	Grounding	OG	Orange
E/A	Output/Input programmable	SnR	Switching Distance Reduction	YE	Yellow
⚡	IO-Link	Rx+/-	Ethernet Receive Path	GN	Green
PoE	Power over Ethernet	Tx+/-	Ethernet Send Path	BU	Blue
IN	Safety Input	Bus	Interfaces-Bus A(+)/B(-)	VT	Violet
OSSD	Safety Output	La	Emitted Light disengageable	GY	Gray
Signal	Signal Output	Mag	Magnet activation	WH	White
BL_D+/-	Ethernet Gigabit bidirect. data line (A-D)	RES	Input confirmation	PK	Pink
EN _{RS422}	Encoder 0-pulse 0/0̄ (TTL)	EDM	Contacting Monitoring	GNYE	Green/Yellow

6 Diagnosis

6.1 LED Indicators

Status	Meaning
	No voltage supply
	Sensor ready for operation
	Switching output 1 active Analog output is not visualized
	An error has occurred. The LED for switching status indicator O1 is deactivated
	There is a warning. The LED for switching status indicator O1 remains active.
	Localization function active The left status LED continues to visualize the output status.

○ = Not lit

● = Permanently lit

⊛ = Flashing

6.2 Troubleshooting

	Possible cause	Elimination
Error and warning	No signal	<ul style="list-style-type: none"> Adjust sensor object distance Minimize environmental influences (air circulation, ultrasonic sources) Check installation
	Object too close	<ul style="list-style-type: none"> Increase sensor object distance
	Object too far	<ul style="list-style-type: none"> Decrease sensor object distance
	Short circuit	<ul style="list-style-type: none"> Check the electrical wiring and eliminate the short circuit
	Undervoltage	<ul style="list-style-type: none"> Check the sensor's voltage supply
	Device error	<ul style="list-style-type: none"> Disconnect the sensor from the supply voltage and restart it Replace the sensor

Via IO-Link, it is possible to identify the respective causes precisely by means of condition monitoring.



NOTICE

Required action in case of fault:

1. Shut down the machine.
2. Analyze and eliminate the cause of error with the aid of the diagnostics information.
3. If the error cannot be eliminated, please contact wenglor's support department.
4. Do not operate in case of indeterminate malfunctioning.
5. The machine must be shut down if the error cannot be definitively explained or properly eliminated.



DANGER

Risk of personal injury or property damage in case of non-compliance!

The system's safety function is disabled. Personal injury and damage to equipment may occur.

→ Required action as specified in case of fault.

7 Settings

The sensor can be set via external teach-in, IO-Link and wTeach2. The different setting options are outlined below.

7.1 Sensor Settings

The three different teach-in modes foreground teach-in, background teach-in and window teach-in are available. These can be configured via IO-Link or via the teach-in keys on the sensor. It should be noted here that the window teach-in must not take place via the key, but exclusively via IO-Link. Foreground teach-in is used by default. Switching output A1 can be taught in using the teach button.

7.1.1 Foreground Teach-In

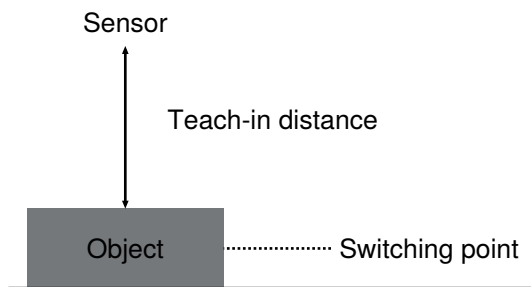

1. Install the sensor in accordance with the installation instructions.
2. Align the sensor with the foreground.
3. Press and hold the teach-in key until switching status indicator LED O1 starts to flash.
4. Release the teach-in key after 2 seconds.
5. The distance is taught in, and LED O1 lights up in order to confirm successful teach-in.



INFORMATION

If no object is in the measuring range, the switching distance is set to the end of the setting range.

7.1.2 Background Teach-In

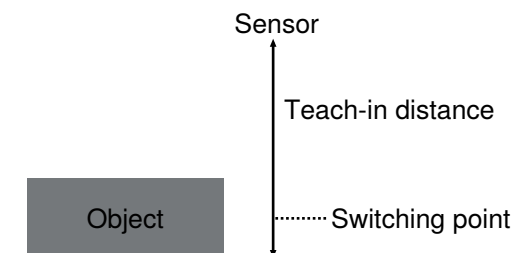

1. Select teach-in mode via IO-Link.
2. Mount the sensor according to the mounting instructions.
3. Align the sensor with the background.
4. Hold down the teach-in key until the LED switching status indicator A1 starts flashing.
5. Release the teach-in key after 2 seconds.
6. The distance is taught in and the LED on A1 lights up to confirm successful teaching.



INFORMATION

If there's no object within the measuring range, switching distance is set to the end of the setting range.

7.2 Setting via IO-Link and wTeach2

The sensors can exchange parameters and process data via IO-Link. The parameters can be used to make many additional settings on the device. The process data transmit cyclical data and condition monitoring.

To this end, the sensor is connected to a suitable IO-Link master (see product detail page/complementary products). The interface protocol and the IO-Link can be found at www.wenglor.com in the download area for the respective product.

For information on installing and connecting the wTeach2 software and its structure, as well as information on the general functions, see the wTeach2 operating instructions. They can be found online in the download area at www.wenglor.com under order number DNNF005.

7.2.1 Window teach-in

In addition to foreground teach-in (default setting), there is also a window teach-in option for the switching output:

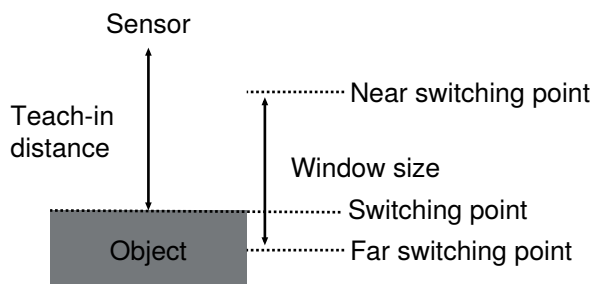

1. Enter the far switching point.
2. Enter the near switching point.
3. The sensor is switched when an object is located between the two switching points.



INFORMATION

The far switching point must be greater than the near switching point.

7.2.2 Through-Beam Sensor Operating Mode

In addition to the reflex mode (default setting), a through-beam operating mode is also available. Two sensors are required to this end.

1. Set up one sensor as an emitter.
2. Set up another sensor as a receiver.
3. If the receiver is operated as a normally closed contact, it is switched when an object is located between the emitter and the receiver.

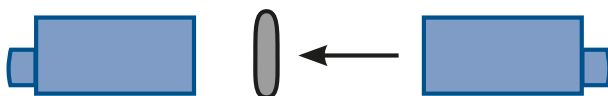



INFORMATION

1. The sonic cone setting on the receiver determines the sensitivity of the through-beam sensor:
2. The maximum range can be achieved with the standard sonic cone.



INFORMATION

Sensors in reflex and through-beam mode must not be combined!

Differentiation between one and two layers of thin material such as paper or foil is possible in the through-beam operating mode.

1. Position the emitter and the receiver a short distance from each other.
2. Adjust the distance between the emitter and the receiver so that the receiver continues to switch for one layer but not for two.

7.2.3 Synchronous Mode of Operation

Up to 32 sensors can be used together in synchronous mode in order to detect a larger surface area. The sensors emit ultrasonic pulses simultaneously (synchronously).

1. Connect pin 5 of all sensors to each other.
2. Sensors automatically start synchronous mode (mode of operation = synchronous).

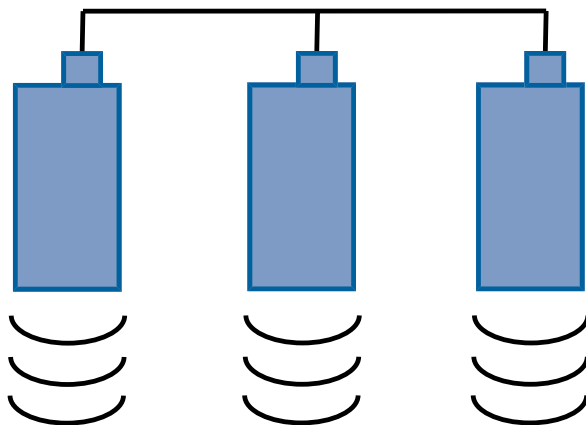

INFORMATION

Synchronous mode is designed for direct connection.

In synchronous mode, both outputs on pin 2 and pin 4 can still be used, as synchronization runs exclusively via pin 5. The pin function for E3 is automatically adjusted by selecting the synchronous mode of operation. Other functions on this pin, such as External Teach, are automatically overwritten in the sensor and are not available.

7.2.4 Multiplex Mode

A maximum of 16 sensors can be used together in multiplex mode in order to detect a larger surface area. The sensors emit pulsed ultrasonic pulses alternately.

1. Connect all of the sensors' pin 5 terminals to each other.
2. Set a sensor as "Multiplex Master" and store the number of "Multiplex Sub Units" involved.
3. Set all other sensors as "Multiplex Sub Unit". Every Sub Unit must be assigned as an address 1...15.

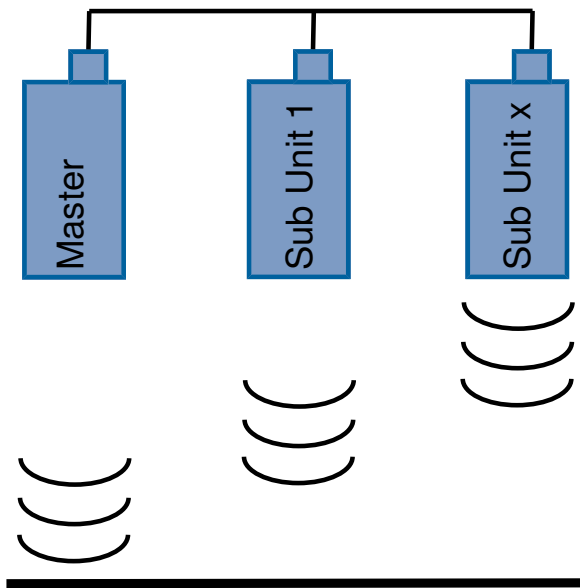

INFORMATION

In multiplex mode, both outputs on pin 2 and pin 4 can still be used, as this mode of operation runs exclusively via pin 5. The pin function for E3 is automatically adjusted by selecting the multiplex mode of operation. Other functions on this pin, such as External Teach, are automatically overwritten in the sensor and are not available.

7.2.5 Analog Output

The sensor reads out its measured value as a linear proportional voltage value. The voltage output can be scaled and inverted via IO-Link.

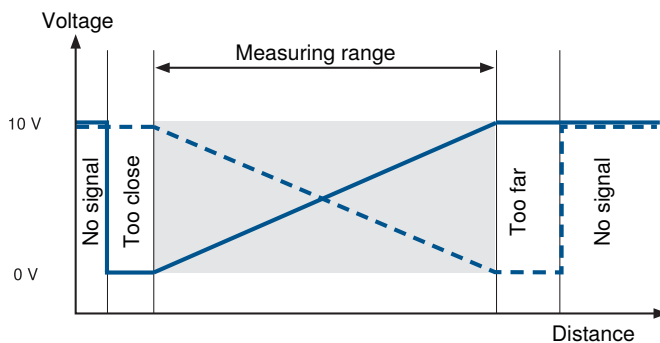

7.2.6 Additional Functions and Settings

Function	Possible settings	Default
Filter	The selected filter affects the response time (see General Data) and the number of distance values that will be evaluated.	
	Filter	Description
	0-15	Median filter Median filter from the specified number of measured values. If the signal is missing or invalid, an error is issued.

Function	Possible settings	Default
	<p>This filter can provide additional smoothing of the signal in applications with objects with a homogeneous surface in a stable environment.</p>	
	0 Median filter of 3 measured values	
	1 Median filter of 4 measured values	
	2 Median filter of 5 measured values	
	3 Median filter of 6 measured values	
	4 Median filter of 7 measured values	
	5 Median filter of 8 measured values	
	6 Median filter of 9 measured values	
	7 Median filter of 10 measured values	
	8 Median filter of 11 measured values	
	9 Median filter of 12 measured values	
	10 Median filter of 13 measured values	
	11 Median filter of 14 measured values	
	12 Median filter of 15 measured values	
	13 Median filter of 16 measured values	
	14 Median filter of 17 measured values	
	15 Median filter of 18 measured values	
	<p>16–20 Special filter from a defined number of measured values with bridging of missing measured values. The additional interference filter can be used to increase measurement reliability in the case of brief interferences in the measured section. Waves, air vortexes, sound-absorbing areas or bulk solids generate temporarily invalid signals that can lead to incorrect measurements. A higher filter level allows the interfering signals to be ignored for a defined period. If the distance changes continuously, the response time remains unchanged when the filter is activated.</p>	
	16 Filter of 19 measured values and bridging of 4 missing measured values (74 ms)	
	17 Filter of 23 measured values and bridging of 7 missing measured values (130 ms)	
	18 Filter of 27 measured values and bridging of 15 missing measured values (278 ms)	
	19 Filter of 28 measured values and bridging of 28 missing measured values (574 ms)	
	20 Filter of 28 measured values and bridging of 28 missing measured values (1148 ms)	
	<p>NOTE! The technical data resulting from the various modes are specified in General Data.</p>	
Transmission signal	<p>The transmit signal of the sensor can be switched off. This allows the sensor to be deactivated when not in use and, if necessary, interference can be avoided.</p> <p>On Transmit signal is on.</p> <p>Off Transmit signal is off. No measurements are taken. The switching behavior is identical to when no signal is received in reflective operation or as a through-beam sensor.</p>	On

Function	Possible settings	Default
Sonic cone	<p>This setting can be used to adjust the shape and range of the sonic cone. The diagrams for the individual sonic cones on standardized objects can be found in Sonic cone diagrams. Narrow cones can be used to block out constant disturbances in the measuring section (e.g. tank walls).</p> <p>Standard</p> <p>Narrow</p> <p>Extra narrow</p>	Standard
Localization	<p>The status display of the sensor can be switched to flashing. This makes it easy to localize the sensor in a system.</p> <p>On</p> <p>Status display flashes green</p> <p>Off</p> <p>Status display in normal function</p>	Off
Measured value unit (process data type)	<p>The measured distance can be read out in millimeters or inches.</p> <p>Millimeter</p> <p>Read-out of distance values in mm for internal temperature compensation or external temperature compensation via the parameters</p> <p>Inch</p> <p>Read-out of distance values in 1/10 inch for internal temperature compensation or external temperature compensation via the parameters</p> <p>Millimeter (with external temperature)</p> <p>Output of distance values in mm and input of external temperature via Process Data Out</p> <p>Inch (with external temperature)</p> <p>Output of distance values in 1/10 inch and input of external temperature via Process Data Out</p>	Millimeter
Temperature mode	<p>The sensor has internal temperature compensation. Alternatively, the temperature can be measured externally and sent to the sensor as a process or parameter.</p> <p>Internal</p> <p>Sensor operates with internal temperature compensation.</p> <p>External</p> <p>Sensor works with external temperature compensation and uses the transmitted process or parameters (see section Condition monitoring/Process data). Whether process or parameter data is to be used is specified via the setting under Measured value unit > Process data type.</p>	Internal
External Temperature	<p>Temperature values can be transmitted to the sensor at a resolution of 1 °C for temperature compensation. Parameter is used if the external temperature compensation is to work via the parameters.</p> <p>–30...+60 °C</p> <p>NOTE!</p> <p>Regular update of external temperature data is recommended to prevent temperature jumps and resulting jumps in the measurement result. If no temperature value is transmitted when the sensor is started up in the external temperature mode, the standard value of 23 °C is used.</p>	23 °C
Reset	<p>Restore Factory Reset</p> <p>The sensor is reset to the factory settings. The saved tags are also deleted.</p>	

Function	Possible settings	Default
	<p>Application Reset</p> <p>The sensor is reset to the factory settings. The saved tags are retained.</p> <p>Back-to-Box</p> <p>The sensor is reset to the factory settings. The saved tags are deleted and IO-Link communication is interrupted. The sensor must then be reconnected to the IO-Link master.</p> <p>Device Reset</p> <p>The sensor settings including tags are retained. The IO-Link communication is re-initiated.</p>	

See also

- ▣ Sonic Cone Diagrams [▶ 10]
- ▣ Condition Monitoring/Process Data [▶ 25]

7.2.7 Condition Monitoring Functions

7.2.7.1 Status Message Function

The sensor provides various status messages. Due to the process data structure, four status messages can be transmitted as individual process data.

These parameters can be used to set the status messages that are transmitted via the process data.

Function	Possible Settings	Default
Message 1	See table "Status Messages"	Device error
Message 2	See table "Status Messages"	Short circuit
Message 3	See table "Status Messages"	Undervoltage
Message 4	See table "Status Messages"	No signal

7.2.7.2 Warning and Error Output Function

The status messages used to trigger the collective message can be defined for the warning and error output respectively. The status messages are OR-linked so that the output is activated when one of the defined status messages is activated.

Function	Possible settings	Default
Warning output	See table "Status Messages"	Signal warning, undervoltage
Error output	See table "Status Messages"	No Measuring data Short circuit Device error

Status Messages

Warning and Error	
Warning signal	The object reflects too little sound (weak signal).
Undervoltage	The supply voltage is too low.
Emitter off	The emitter of the sensor is switched off.
No signal	The sensor is not receiving a signal. The error can occur, for example, due to:

Warning and Error	
	<ul style="list-style-type: none"> • Strong air turbulence • Excessively strong ultrasonic sources in the measuring range • Very small or poorly reflective (sound-absorbing) objects are located within the working range • Incorrect installation
Object too close	The object is below the setting range or the set measuring range.
Object too far	The object is above the setting range or the set measuring range.
Short circuit	A short circuit has occurred on at least one pin.
Device error	A hardware error has occurred.

7.2.7.3 Simulation Functions

This function simulates the behavior of the sensor regardless of the current status and measured value. This can be used to check whether a plant in which the sensor is integrated reacts correctly to the data supplied by the sensor and processes them accordingly.

If a measured value is specified, the sensor behaves as if the specified measured value corresponds to the actual measured value. This means that the behavior of the outputs and status messages is simulated according to the specified measured value.

In addition, the individual outputs and status messages can be simulated separately from the measured value.



INFORMATION

Output A1 is used for IO-Link communication in this function and cannot be simulated. Simulation mode ends automatically as soon as the power supply is interrupted.

7.2.8 Condition Monitoring/Process Data

The data described in the following section can be read or written cyclically via IO-Link/process data.

7.2.8.1 Process Data In

Data	Meaning
Measured value	Measured distance in mm or 1/10 inch As the sensor cannot determine a measured value in the following error cases, substitute values are read out: No signal: 0x7FFC / 32764 mm Object too close: 0x8008 / -32760 mm Object too far: 0x7FF8 / 32760 mm
Scale	Scaling of the measured value to the base length unit; -3 corresponds to mm.
SSC1	Switching point 1
SSC2	Switching point 2
Warning	Collective warning in the event of one of the warning status messages (see table "Status messages") in the error output function)
Error	Collective warning in the event of one of the error status messages (see table "Status messages") in error output function.
Message 1	Status message 1 read out see Status Message Function [▶ 24]
Message 2	Status message 2 read out see Status Message Function [▶ 24]
Message 3	Status message 3 read out see Status Message Function [▶ 24]
Message 4	Status message 4 read out see Status Message Function [▶ 24]

7.2.8.2 Process Data Out

Data	Meaning
Transmission signal	Transmit signal on/off
Teach-in SSC1	Starts the teach-in process for SSC1
Teach-in SSC2	Starts the teach-in process for SSC2
External temperature value	Enter the external temperature in °C for temperature compensation
Localization	Sensor flashes for easy sensor location

7.3 Pin Functions

The most important pin functions are shown below.

Pin	Possible settings	Default
E/A1	<p>Switching output</p> <p>Switching point SSC1 is assigned to the switching output.</p> <p>Error output</p> <p>The error output switches if one of the assigned errors occurs; see table "Status messages".</p> <p>Warning output</p> <p>The warning output switches if one of the assigned warnings occurs; see table "Status messages".</p> <p>Transmit Signal Off input</p> <p>The sensor's transmit signal is deactivated as long as the input is activated. The sensor does not send a measured value and sets the status to "No signal".</p> <p>Deactivated</p> <p>The pin is deactivated</p>	Switching output
O	Voltage output	Voltage output
E3	<p>teach-in input</p> <p>Switching output A1 can be taught in normal mode of operation via pin 5.</p> <p>Deactivated</p> <p>The pin is deactivated.</p> <p>Synchronous input/output*</p> <p>The input is used for communication between the connected sensors.</p> <p>multiplex input/output*</p> <p>The input is used for communication between the Multiplex Master Unit and Multiplex Sub Unit.</p>	Synchronous input/output

The pin function on E3 is adjusted for the synchronous and multiplex operating modes by selecting the operating mode. The setting is made automatically in the device. Adjustment via IO-Link is obsolete, which is why the synchronous and multiplex pin functions cannot be selected as setting options.

7.3.1 Input Functions

Function	Possible settings	Default
External teach-in	<p>Supply voltage active</p> <p>Function is triggered as soon as supply voltage is applied to the input.</p> <p>Note:</p>	Supply voltage active

Function	Possible settings	Default
	The time intervals required for this are: Activated for 2 sec. = Teach-in A1	
Transmission signal can be switched off	Supply voltage active Send signal on as soon as Ub is applied to the input Supply voltage inactive Transmission signal on as soon as 0 V is applied or the input is opened.	Supply voltage active

7.3.2 Output Functions

The output functions are used to set the physical outputs.

Function	Possible settings and functions	Default
PNP/NPN/ Push-pull	PNP NPN Push-pull	PNP
NC/ NO	Normally Open (NO) The output is active when the condition has been satisfied, depending on settings (switching point, warning, error). Normally Closed (NC) The output is inactive when the condition has been satisfied, depending on settings (switching point, warning, error).	NO
Analog output	Voltage output	Voltage output
Additional hysteresis	0...200 mm	0 mm

Warning and Error Output

The error and warning output switches as soon as a fault or warning type has been assigned to it and the condition is fulfilled.

8 Maintenance Instructions



NOTICE

This wenglor product is maintenance-free.

Cleaning and inspection of the plug connections at regular intervals are advisable.

Do not clean the product with solvents or cleaning agents that could damage the product.

The product must be protected against contamination during initial start-up.

9 Proper Disposal

wenglor sensoric GmbH does not accept the return of unusable or irreparable products. Respectively valid national waste disposal regulations apply to product disposal.

10 **Declarations of Conformity**

Declarations of conformity can be found on our website at www.wenglor.com in the product's separate download area.