

Operating Instructions
P1KL015
Retro-Reflex Sensor universal



EN



Table of Contents

1	General	3
1.1	Information Concerning these Instructions	3
1.2	Explanation of Symbols	3
1.3	Limitation of Liability	4
1.4	Copyrights	4
2	For Your Safety	5
2.1	Use for Intended Purpose	5
2.2	Use for Other than the Intended Purpose	5
2.3	Personnel Qualifications	5
2.4	Modification of Products	6
2.5	General Safety Precautions	6
2.6	Laser Warnings	6
2.7	Approvals and Protection Class	6
3	Technical Data	7
3.1	General Data	7
3.1.1	Light Spot Diameter	8
3.1.2	Smallest Recognizable Part	8
3.1.3	Switching Distance	8
3.2	Housing Dimensions	9
3.3	Control Panel	9
3.4	Complementary Products	9
3.5	Scope of delivery	10
4	Transport and Storage	11
4.1	Transport	11
4.2	Storage	11
5	Installation and Electrical Connection	12
5.1	Installation	12
5.2	Electrical Connection	12
5.3	Diagnosis	13
6	Settings	15
6.1	Adjustment via Potentiometer	15
6.2	Setting via IO-Link and wTeach2	15
7	Maintenance Instructions	16
8	Proper Disposal	17
9	Declarations of Conformity	18

1 General

1.1 Information Concerning these Instructions

- These instructions make it possible to use the product safely and efficiently.
- These instructions are an integral part of the product and must be kept on hand for the entire duration of its service life.
- Local accident prevention regulations and national work safety regulations must be complied with as well.
- The product is subject to further technical development, and thus the information contained in these operating instructions may also be subject to change. The current version can be found at www.wenglor.com in the product's separate download area.



INFORMATION

The operating instructions must be read carefully before using the product and must be kept on hand for later reference.

1.2 Explanation of Symbols

- Safety precautions and warnings are emphasized by means of symbols and signal words.
- Safe use of the product is only possible if these safety precautions and warnings are adhered to.

The safety precautions and warnings are laid out in accordance with the following principle:

SIGNAL WORD

Type and source of danger!

Possible consequences in the event that the hazard is disregarded.

→ Measures for averting the hazard.

The meanings of the signal words, as well as the scope of the associated hazards, are listed below:



DANGER

This signal word indicates a hazard with a high degree of risk which, if not avoided, results in death or severe injury.



WARNING

This signal word indicates a hazard with a medium degree of risk which, if not avoided, may result in death or severe injury.



CAUTION

This signal word indicates a hazard with a low degree of risk which, if not avoided, may result in minor or moderate injury.



NOTICE

This signal word draws attention to a potentially hazardous situation which, if not avoided, may result in property damage.



INFORMATION

Information draws attention to useful tips and suggestions, as well as information on efficient, error-free use.

1.3 Limitation of Liability

- The product has been developed in consideration of the current state-of-the-art technology, as well as applicable standards and guidelines. Subject to change without notice.
- A valid declaration of conformity can be accessed at www.wenglor.com in the product's separate download area.
- wenglor sensoric elektronische Geräte GmbH (hereinafter referred to as "wenglor") excludes all liability in the event of:
 - Non-compliance with the instructions
 - Use of the product for purposes other than those intended.
 - Use by untrained personnel.
 - Use of unapproved spare parts.
 - Unapproved modification of products.
- These operating instructions do not include any guarantees from wenglor with regard to the described procedures or specific product characteristics.
- wenglor assumes no liability for printing errors or other inaccuracies contained in these operating instructions unless wenglor was verifiably aware of such errors at the point in time at which the operating instructions were prepared.

1.4 Copyrights

- The contents of these instructions are protected by copyright law.
- All rights are reserved by wenglor.
- Commercial reproduction or any other commercial use of the provided content and information, in particular graphics and images, is not permitted without previous written consent from wenglor.

2 For Your Safety

2.1 Use for Intended Purpose

Retro-Reflex Sensors

In the case of retro-reflex sensors, the emitter and the receiver are located in one housing. They work with red or laser light and a reflector. If the light beam between the sensor and the reflector is interrupted, the output is switched. Even shiny objects such as mirrors, chrome plated or other reflective surfaces can be reliably recognized thanks to the integrated polarization filter.

This product can be used in the following industry sectors:

- Special-purpose mechanical engineering
- Heavy mechanical engineering
- Logistics
- Automotive industry
- Food industry
- Packaging industry
- Pharmaceuticals industry
- Plastics industry
- Woodworking industry
- Consumer goods industry
- Paper industry
- Electronics industry
- Glass industry
- Steel industry
- Aviation industry
- Chemicals industry
- Alternative energies
- Raw materials extraction

2.2 Use for Other than the Intended Purpose

- Not a safety component in accordance with 2006/42/EC (Machinery Directive).
- The product is not suitable for use in potentially explosive atmospheres.
- The product may be used only with accessories supplied or approved by wenglor, or in combination with approved products. A list of approved accessories and combination products can be found at www.wenglor.com on the product detail page.



DANGER

Risk of personal injury or property damage in case of use for other than the intended purpose!

Use for other than the intended purpose may lead to hazardous situations.

→ Observe instructions regarding use for intended purpose.

2.3 Personnel Qualifications

- Suitable technical training is a prerequisite.
- In-house electronics training is required.
- Trained personnel who use the product must have (permanent) access to the operating instructions.



DANGER

Risk of personal injury or property damage in case of incorrect initial start-up and maintenance!

Personal injury and damage to equipment may occur.

→ Adequate training and qualification of personnel

2.4 Modification of Products



DANGER

Risk of personal injury or property damage if the product is modified!

Personal injury and damage to equipment may occur. Noncompliance may result in loss of the CE mark and voiding of the warranty.

→ Modification of the product is not permitted

2.5 General Safety Precautions



INFORMATION

These instructions are an integral part of the product and must be kept on hand for the entire duration of its service life.

In the event of possible changes, the current version of the operating instructions can be found at www.wenglor.com in the product's separate download area.

Read the operating instructions carefully before using the product.

Protect the sensor against contamination and mechanical influences.

2.6 Laser Warnings

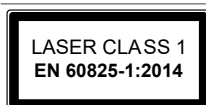

Laser Class 1 (EN 60825-1)

Applicable standards and safety regulations must be observed.

2.7 Approvals and Protection Class

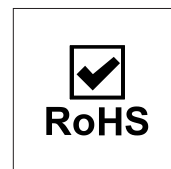
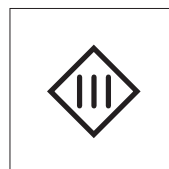
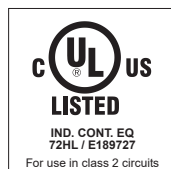

3 Technical Data

3.1 General Data

Technical Data	
Optical Data	
Range	12000 mm
Reference Reflector/Reflector Foil	RE6151BM
Switching Hysteresis	< 15 %
Light Source	Laser collimated (red)
Wavelength	655 nm
Laser Class (EN 60825-1)	1
Polarization Filter	yes
Service Life (T = +25 °C)	100000 h
Max. Ambient Light	10000 Lux
Light Spot Diameter	see section Light Spot Diameter [► 8]
Smallest Recognizable Part	see section Smallest Recognizable Part [► 8]
Two-Lens Optic	yes
Electrical Data	
Supply Voltage	10 ... 30 V DC
Supply Voltage with IO-Link	18 ... 30 V DC
Current Consumption (U _b = 24 V)	< 15 mA
Switching Frequency	2000 Hz
Switching frequency (speed mode)	4000 Hz
Response Time	0.25 ms
Response time (speed mode)	0.125 ms
Temperature Drift	< 10 %
Temperature Range	-40 ... 60 °C
Switching Output Voltage Drop	< 2 V
Switching Output/Switching Current	100 mA
Residual Current Switching Output	< 50 µA
Short Circuit and Overload Protection	yes
Reverse Polarity Protection	yes
Lockable	yes
Interface	IO-Link V1.1
Protection Class	III
Mechanical Data	
Setting Method	Potentiometer
Housing Material	Plastic, ABS/PC
Degree of Protection	IP67/IP68
Connection	M8 × 1; 3-pin
Optic Cover	Plastic, PMMA
Technical Safety Data	
MTTFd (EN ISO 13849-1)	2633.47 a
Output Functions	
Output	NPN
	NO

3.1.1 Light Spot Diameter

Working Distance	0,1 m	5 m	12 m
Light Spot Diameter	4 mm	11 mm	22 mm

3.1.2 Smallest Recognizable Part

Distance, Sensor to Reflector	2 m	4 m	12 m
Smallest Recognizable Part	1,5 mm	1 mm	2,5 mm

3.1.3 Switching Distance

Achievable switching distance depends on the utilized reflector. The nominal switching distance is achieved with the reference reflector specified in the technical data. Achievable ranges for other reflectors are listed in the following table:

Reflector	Range
RQ100BA	0.1 ... 16 m
RE18040BA	0.1 ... 12 m
RQ84BA	0.1 ... 16 m
RR84BA	0.1 ... 16 m
RE9538BA	0.1 ... 4.5 m
RE6151BM	0.1 ... 12 m
RR50_A	0.1 ... 16 m
RE6040BA	0.1 ... 15 m
RE8222BA	0.1 ... 10 m
RR34_M	0.1 ... 2.5 m
RE3220BM	0.1 ... 7 m
RE6210BM	0.1 ... 4.5 m
RR25_M	0.1 ... 7 m
RR25KP	0.1 ... 2.5 m
RR21_M	0.1 ... 4 m
Z90R004	0.15 ... 5 m
Z90R005	0.15 ... 5.9 m
ZRAE02B01	0.1 ... 7 m
ZRME01B01	0.1 ... 3 m
ZRME03B01	0.1 ... 4.5 m
ZRMR02K01	0.1 ... 3 m
ZRMS02_01	0.1 ... 4 m
ZRDF03K01	0.1 ... 4 m
ZRDF10K01	0.1 ... 4 m
RF505	0.1 ... 2 m
RF508	0.1 ... 2 m
RF258	0.1 ... 2 m

3.2 Housing Dimensions

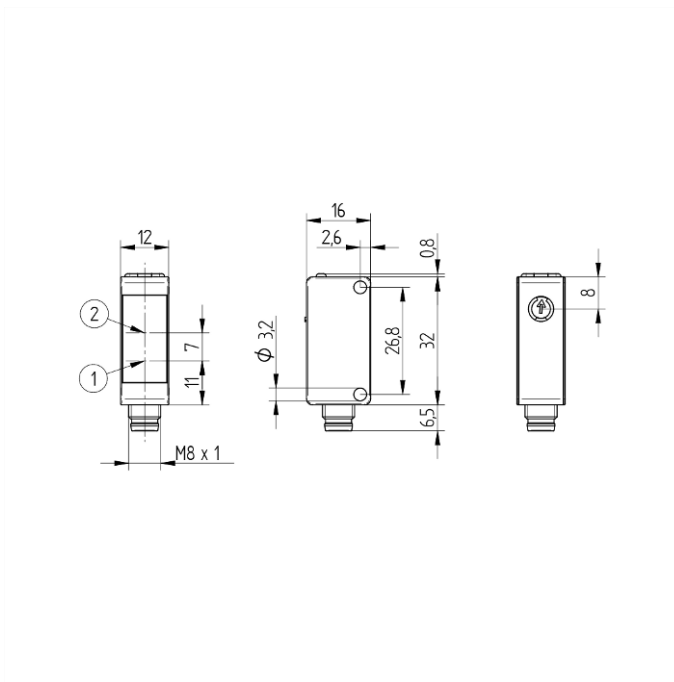

① = emitted light

② = receiver diode

M3 screw = 0.5 Nm

Potentiometer = 40 Nmm

Dimensions specified in mm (1 mm = 0.03937")

3.3 Control Panel

1K1

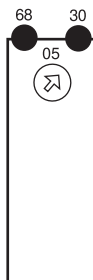

05 = switching distance adjuster

30 = switching status indicator / contamination warning

68 = supply voltage indicator

3.4 Complementary Products

wenglor offers you the right connection and mounting technology as well as other accessories for your product. You can find this at www.wenglor.com on the product details page at the bottom.

3.5 Scope of delivery

- Sensor
- Safety precaution

4 Transport and Storage

4.1 Transport

Upon receipt of shipment, the goods must be inspected for damage in transit. In the case of damage, conditionally accept the package and notify the manufacturer of the damage. Then return the device, making reference to damage in transit.

4.2 Storage

The following points must be taken into consideration with regard to storage:

- Do not store the product outdoors.
- Store the product in a dry, dust-free place.
- Protect the product against mechanical impacts.
- Protect the product against exposure to direct sunlight.



NOTICE

Risk of property damage in case of improper storage!

The product may be damaged.

→ Storage instructions must be complied with.

5 Installation and Electrical Connection

5.1 Installation

- Protect the product from contamination during installation.
- Observe all applicable electrical and mechanical regulations, standards and safety rules.
- Protect the product against mechanical influences.
- Make sure that the sensor is mounted in a mechanically secure fashion.
- Specified torque values must be complied with (see section Technical Data [► 7]).



NOTICE

Risk of property damage in case of improper installation!

The product may be damaged!

→ Comply with installation instructions.



CAUTION

Risk of personal injury or property damage during installation!

Personal injury and damage to the product may occur.

→ Ensure a safe installation environment.

5.2 Electrical Connection

- Wire the sensor in accordance with the connection diagram.
- Switch on the supply voltage (see section Technical Data [► 7]).
- If using IO-Link, connect the sensor to 18...30 V DC.
- If not using IO-Link, connect the sensor to 10...30 V DC.



DANGER

Risk of personal injury or property damage due to electric current.

Voltage-conducting parts may cause personal injury or damage to equipment.

→ The electric device may be connected by appropriately qualified personnel only.

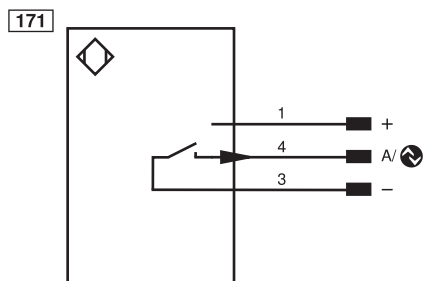

Legend

+	Supply Voltage +
-	Supply Voltage 0 V
~	Supply Voltage (AC Voltage)
A	Switching Output (NO)
\bar{A}	Switching Output (NC)
V	Contamination/Error Output (NO)
\bar{V}	Contamination/Error Output (NC)
E	Input (analog or digital)
T	Teach Input
Z	Time Delay (activation)
S	Shielding
RxD	Interface Receive Path
TxD	Interface Send Path
RDY	Ready
GND	Ground
CL	Clock
E/A	Output/Input programmable
	IO-Link
PoE	Power over Ethernet
IN	Safety Input
OSSD	Safety Output
Signal	Signal Output
BI_D+/-	Ethernet Gigabit bidirect. data line (A-D)
EN0_r542z	Encoder 0-pulse 0-0̄ (TTL)
PT	Platinum measuring resistor
nc	not connected
U	Test Input
\bar{U}	Test Input inverted
W	Trigger Input
W-	Ground for the Trigger Input
O	Analog Output
O-	Ground for the Analog Output
BZ	Block Discharge
AVV	Valve Output
a	Valve Control Output +
b	Valve Control Output 0 V
SY	Synchronization
SY-	Ground for the Synchronization
E+	Receiver-Line
S+	Emitter-Line
\pm	Grounding
SnR	Switching Distance Reduction
Rx+/-	Ethernet Receive Path
Tx+/-	Ethernet Send Path
Bus	Interfaces-Bus A(+)/B(-)
La	Emitted Light disengageable
Mag	Magnet activation
RES	Input confirmation
EDM	Contacting Monitoring
ENAr542z	Encoder A/ \bar{A} (TTL)
ENBr542z	Encoder B/ \bar{B} (TTL)
ENA	Encoder A
ENb	Encoder B
AMIN	Digital output MIN
AMAX	Digital output MAX
AOK	Digital output OK
SY In	Synchronization In
SY OUT	Synchronization OUT
OLT	Brightness output
M	Maintenance
rsv	reserved
Wire Colors according to IEC 60757	
BK	Black
BN	Brown
RD	Red
OG	Orange
YE	Yellow
GN	Green
BU	Blue
VT	Violet
GY	Grey
WH	White
PK	Pink
GNYE	Green/Yellow

5.3 Diagnosis

Causes triggering the contamination warning (flashing LED):

Display LED	Diagnosis/Cause	Elimination
Continuous flashing at approx. 2.5 Hz	Contamination	Carefully clean the optic cover with a cloth
	Aged emitter diode	Replace the sensor
	Unreliable working range	<ul style="list-style-type: none"> • Increase the sensor's switching distance • Reduce distance between sensor and reflector
Continuous flashing at approx. 5 Hz	Short circuit	Check electrical wiring and eliminate the short circuit
	Over-temperature	Disconnect the sensor from the supply voltage and allow it to cool
	Hardware error	Replace the sensor

Contamination Warning Flowcharts

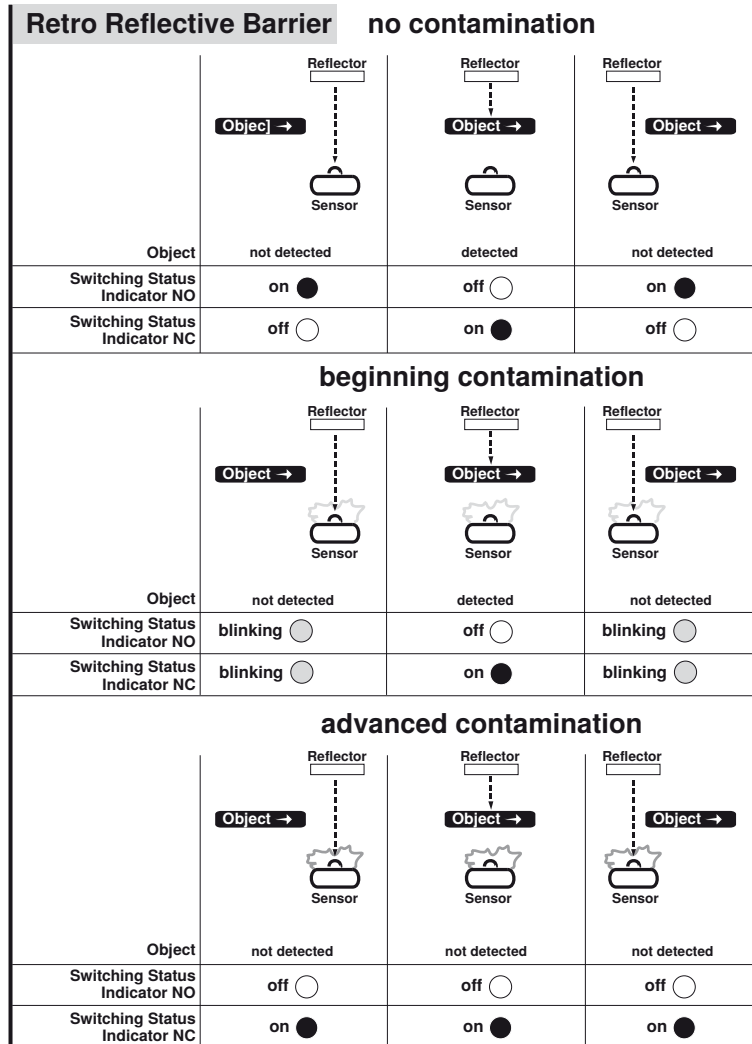

NOTICE

Required action in case of fault:

1. Shut down the machine.
2. Analyze and eliminate the cause of error with the aid of the diagnostics information.
3. If the error cannot be eliminated, please contact wenglor's support department.
4. Do not operate in case of indeterminate malfunctioning.
5. The machine must be shut down if the error cannot be definitively explained or properly eliminated.



DANGER

Risk of personal injury or property damage in case of non-compliance!

The system's safety function is disabled. Personal injury and damage to equipment may occur.

→ Required action as specified in case of fault.

6 Settings

The sensor can be set via external teach-in, IO-Link and wTeach2. The different setting options are outlined below.

6.1 Adjustment via Potentiometer

- Align sensor to reflector.
- Make sure that the sensor and the reflector are mounted in a mechanically secure fashion.
- Turn the potentiometer all the way to the right.
- Turn the potentiometer back if required (detection of small or transparent objects).
- Move the object into the sensor's working range and check for correct functioning.

6.2 Setting via IO-Link and wTeach2

The sensors can exchange parameters and process data via IO-Link. The parameters can be used to make many additional settings on the device. The process data transmit cyclical data and condition monitoring.

To this end, the sensor is connected to a suitable IO-Link master (see product detail page/complementary products). The interface protocol and the IODD can be found at www.wenglor.com in the download area for the respective product.

For information on installing and connecting the wTeach2 software and its structure, as well as information on the general functions, see the wTeach2 operating instructions. They can be found online in the download area at www.wenglor.com under order number DNNF005.

7 Maintenance Instructions



NOTICE

This wenglor sensor is maintenance-free.

Cleaning and inspection of the plug connections at regular intervals are advisable.

Do not clean the sensor with solvents or cleaning agents that could damage the product.

The product must be protected against contamination during initial start-up.

8 Proper Disposal

wenglor sensoric GmbH does not accept the return of unusable or irreparable products. Respectively valid national waste disposal regulations apply to product disposal.

9 **Declarations of Conformity**

Declarations of conformity can be found on our website at www.wenglor.com in the product's separate download area.