

Operating Instructions

I08G008

Inductive Sensor with Full-Metal Housing



EN



Table of Contents

1	General	3
1.1	Information Concerning these Instructions	3
1.2	Explanation of Symbols	3
1.3	Limitation of Liability	4
1.4	Copyrights	5
2	For Your Safety	6
2.1	Use for Intended Purpose	6
2.2	Use for Other than the Intended Purpose	6
2.3	Personnel Qualifications	7
2.4	Modification of Products	7
2.5	Safety precautions	7
2.5.1	General Safety Precautions	7
2.5.2	Instructions for Use in Potentially Explosive Atmospheres	7
2.5.3	Intrinsic Safety Barrier Requirements	8
2.6	Approvals and Protection Class	8
3	Technical Data	9
3.1	General Data	9
3.2	Housing Dimensions	10
3.3	Complementary Products	10
3.4	Scope of Delivery	10
4	Transport and Storage	11
4.1	Transport	11
4.2	Storage	11
5	Installation and Electrical Connection	12
5.1	Installation	12
5.2	Installation Instructions	12
5.2.1	Installation Instructions in Accordance with the Standard	12
5.2.2	Installation Instructions for Sensors with weproTec	13
5.2.3	Switching Distance	15
5.3	Electrical Connection	16
5.4	Troubleshooting	17
6	Maintenance Instructions	18
7	Proper Disposal	19
8	Declarations of Conformity	20

1 General

1.1 Information Concerning these Instructions

- These instructions make it possible to use the product safely and efficiently.
- These instructions are an integral part of the product and must be kept on hand for the entire duration of its service life.
- Local accident prevention regulations and national work safety regulations must be complied with as well.
- The product is subject to further technical development, and thus the information contained in these operating instructions may also be subject to change. The current version can be found at www.wenglor.com in the product's separate download area.



INFORMATION

The operating instructions must be read carefully before using the product and must be kept on hand for later reference.

1.2 Explanation of Symbols

- Safety precautions and warnings are emphasized by means of symbols and signal words.
- Safe use of the product is only possible if these safety precautions and warnings are adhered to.

The safety precautions and warnings are laid out in accordance with the following principle:

SIGNAL WORD

Type and source of danger!

Possible consequences in the event that the hazard is disregarded.

→ Measures for averting the hazard.

The meanings of the signal words, as well as the scope of the associated hazards, are listed below:



DANGER

This signal word indicates a hazard with a high degree of risk which, if not avoided, results in death or severe injury.



WARNING

This signal word indicates a hazard with a medium degree of risk which, if not avoided, may result in death or severe injury.



CAUTION

This signal word indicates a hazard with a low degree of risk which, if not avoided, may result in minor or moderate injury.



NOTICE

This signal word draws attention to a potentially hazardous situation which, if not avoided, may result in property damage.



INFORMATION

Information draws attention to useful tips and suggestions, as well as information on efficient, error-free use.

1.3 Limitation of Liability

- The product has been developed in consideration of the current state-of-the-art technology, as well as applicable standards and guidelines. Subject to change without notice.
- A valid declaration of conformity can be accessed at www.wenglor.com in the product's separate download area.
- wenglor sensoric elektronische Geräte GmbH (hereinafter referred to as "wenglor") excludes all liability in the event of:
 - Non-compliance with the instructions
 - Use of the product for purposes other than those intended.
 - Use by untrained personnel.
 - Use of unapproved spare parts.
 - Unapproved modification of products.
- These operating instructions do not include any guarantees from wenglor with regard to the described procedures or specific product characteristics.
- wenglor assumes no liability for printing errors or other inaccuracies contained in these operating instructions unless wenglor was verifiably aware of such errors at the point in time at which the operating instructions were prepared.

1.4 Copyrights

- The contents of these instructions are protected by copyright law.
- All rights are reserved by wenglor.
- Commercial reproduction or any other commercial use of the provided content and information, in particular graphics and images, is not permitted without previous written consent from wenglor.

2 For Your Safety

2.1 Use for Intended Purpose

The inductive sensors with full-metal housing are suitable for harsh ambient conditions and washdown areas thanks to the V4A stainless steel housing. The sensors with full-metal housing impress with their easy installation and reliable switching behavior. In addition to error-free operation of several sensors in a very small space, the new generation also provides the possibility of detecting system errors before it's too late thanks to ASIC, IO-Link interface and wenglor weproTec.

According to ATEX certification 3G and 3D, this sensor can be used in hazardous areas in accordance with 2014/34/EU(ATEX). Further specific installation instructions must be followed.

This product can be used in the following industry sectors:

- Special-purpose mechanical engineering
- Heavy mechanical engineering
- Logistics
- Automotive industry
- Food industry
- Packaging industry
- Pharmaceuticals industry
- Plastics industry
- Woodworking industry
- Clothing industry
- Printing industry
- Consumer goods industry
- Paper industry
- Electronics industry
- Glass industry
- Steel industry
- Aviation industry
- Chemicals industry
- Alternative energies
- Raw materials extraction
- Construction industry
- Agriculture industry

2.2 Use for Other than the Intended Purpose

- Not a safety component in accordance with 2006/42/EC (Machinery Directive).
- The product may be used only with accessories supplied or approved by wenglor, or in combination with approved products. A list of approved accessories and combination products can be found at www.wenglor.com on the product detail page.



⚠ DANGER

Risk of personal injury or property damage in case of use for other than the intended purpose!

Use for other than the intended purpose may lead to hazardous situations.

- Observe instructions regarding use for intended purpose.

2.3 Personnel Qualifications

- Suitable technical training is a prerequisite.
- In-house electronics training is required.
- Trained personnel who use the product must have (permanent) access to the operating instructions.



DANGER

Risk of personal injury or property damage in case of incorrect initial start-up and maintenance!

Personal injury and damage to equipment may occur.

→ Adequate training and qualification of personnel

2.4 Modification of Products



DANGER

Risk of personal injury or property damage if the product is modified!

Personal injury and damage to equipment may occur. Noncompliance may result in loss of the CE mark and voiding of the warranty.

→ Modification of the product is not permitted

2.5 Safety precautions

2.5.1 General Safety Precautions



INFORMATION

These instructions are an integral part of the product and must be kept on hand for the entire duration of its service life.

In the event of possible changes, the current version of the operating instructions can be found at www.wenglor.com in the product's separate download area.

Read the operating instructions carefully before using the product.

Protect the sensor against contamination and mechanical influences.

2.5.2 Instructions for Use in Potentially Explosive Atmospheres

Identification in accordance with directive 2014/34/EU (ATEX)

 II 3G Ex ic IIC T5 Gc

 II 3D Ex tc IIIC T90°Dc

- The device may only be installed, connected and commissioned by qualified personnel. The specialist personnel must be familiar with ignition protection types, regulations and ordinances for equipment in potentially explosive areas.
- Do not disconnect under power!
- The included warning label, “Do not disconnect under power!”, must be attached to the sensor or the mounting device in a plainly visible fashion.
- Under no circumstances may the operating voltage of 30 V be exceeded.
- Stipulations set forth in EN 60079-0 regarding temperatures and dust deposits must be adhered to.

2.5.3 Intrinsic Safety Barrier Requirements

The safety barrier must meet the following requirements:

- $U_o(\text{barrier}) \leq U_i$
- $I_o(\text{barrier}) \leq I_i$
- $P_o(\text{barrier}) \leq P_i$
- $C_o(\text{barrier}) \geq C_{\text{cable}} + C_i$
- $L_o(\text{barrier}) \geq L_{\text{cable}} + L_i$

Parameters of the sensor unit:

- $U_i = 30 \text{ VDC}$ – input voltage
- $I_i = 100 \text{ mA}$ – input current
- $P_i = 0.9 \text{ W}$ – input power
- $C_{\text{cable}} + C_i = 80 \text{ nF}$ – input capacitance
- $L_{\text{cable}} + L_i = 5 \text{ }\mu\text{H}$ – input inductance

2.6 Approvals and Protection Class

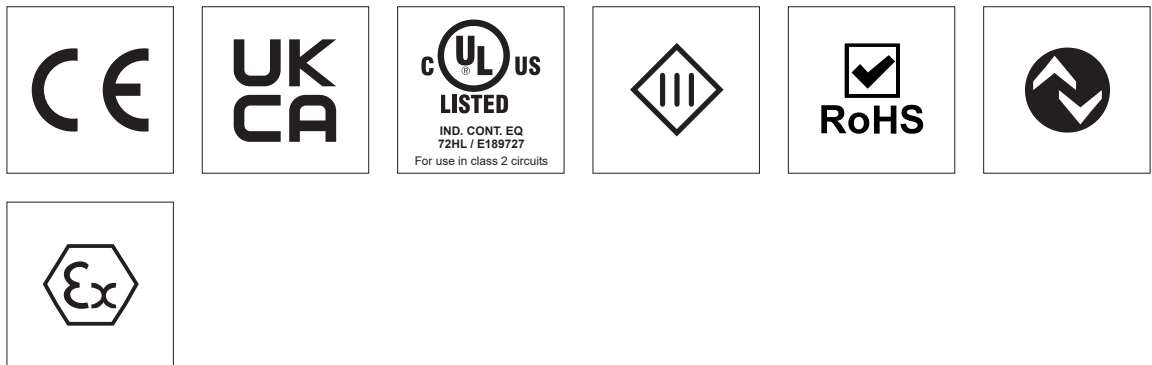

3 Technical Data

3.1 General Data

Technical Data	
Inductive Data	
Switching Distance	4 mm
Correction Factors Stainless Steel V2A/CuZn/Al	1,03/0,44/0,41
Mounting	Non-flush
Mounting A/B/C/D in mm	8/28/12/10
Mounting A/B/C/D (V2A) in mm	8/28/12/10
Mounting B1 in mm	0...6
Installation B1 (V2A) in mm	0...6
Switching Hysteresis	< 10 %
Electrical Data	
Supply Voltage	10 ... 30 V DC
Supply Voltage with IO-Link	18 ... 30 V DC
Current Consumption (U _b = 24 V)	< 15 mA
Switching Frequency	529 Hz
Temperature Drift	< 10 %
Temperature Range	-25 ... 70 °C
Switching Output Voltage Drop	< 1 V
Switching Output/Switching Current	100 mA
Residual Current Switching Output	< 100 µA
Short Circuit Protection	yes
Reverse Polarity and Overload Protection	yes
Interface	IO-Link V1.1
Mechanical Data	
Housing Material	Stainless steel, V4A (1.4404 / 316L)
Sensing face	Stainless steel, V4A
Degree of Protection	IP67/IP68/IP69K *
Connection	M8 × 1; 3-pin
Torque	max. 5 Nm
Pressure Resistance Sensor Area	60 bar
EX II 3G Ex ic IIC T5 Gc	yes
EX II 3D Ex tc IIIC T90° Dc	yes
Safety-Relevant Data	
MTTFd (EN ISO 13849-1)	3706.54 a
Output	
Output	NPN
	NC

* For applications inside hazardous areas: IP67

3.2 Housing Dimensions

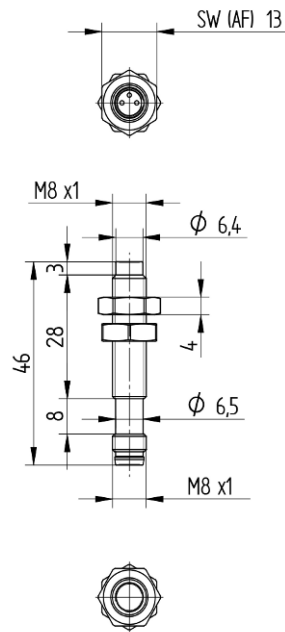

Dimensions specified in mm (1 mm = 0.03937 Inch)

3.3 Complementary Products

wenglor offers you the right connection and mounting technology as well as other accessories for your product. You can find this at www.wenglor.com on the product details page at the bottom.

3.4 Scope of Delivery

- Sensor
- ZNNE008 M8 × 1 hex nuts
- ATEX label

4 Transport and Storage

4.1 Transport

Upon receipt of shipment, the goods must be inspected for damage in transit. In the case of damage, conditionally accept the package and notify the manufacturer of the damage. Then return the device, making reference to damage in transit.

4.2 Storage

The following points must be taken into consideration with regard to storage:

- Do not store the product outdoors.
- Store the product in a dry, dust-free place.
- Protect the product against mechanical impacts.
- Protect the product against exposure to direct sunlight.



NOTICE

Risk of property damage in case of improper storage!

The product may be damaged.

→ Storage instructions must be complied with.

5 Installation and Electrical Connection

5.1 Installation

- Protect the product from contamination during installation.
- Observe all applicable electrical and mechanical regulations, standards, and safety rules.
- Protect the product against mechanical influences.
- Make sure that the sensor is mounted in a mechanically secure fashion.
- Specified torque values must be complied with (see section Technical Data [► 9]).
- The active surface of the sensor may not contact any other machine parts.
- Installation regulations must be complied with (see section Technical Data [► 9]).



NOTICE

Risk of property damage in case of improper installation!

The product may be damaged!

→ Comply with installation instructions.



CAUTION

Risk of personal injury or property damage during installation!

Personal injury and damage to the product may occur.

→ Ensure a safe installation environment.

5.2 Installation Instructions

5.2.1 Installation Instructions in Accordance with the Standard

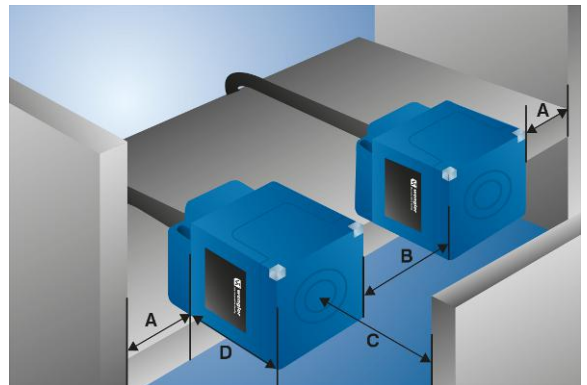
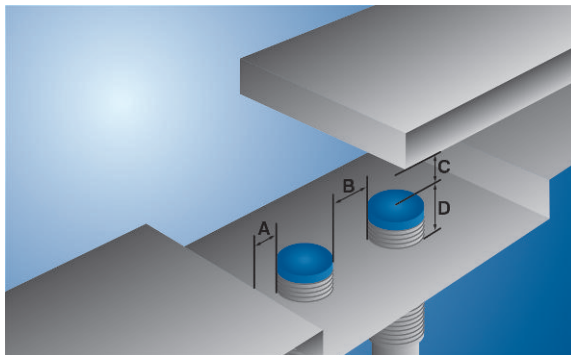



Installation dimension	Description
A	Minimum distance from sensor to damping material (e.g. steel).
B	Minimum distance between two inductive sensors. This distance applies to installation in air. If the sensors are installed within an attenuating material (e.g. steel), this distance is reduced. Testing in the application is required in order to determine the exact distance.
C	Minimum distance from the sensing face of the inductive sensor to the damping material (e.g. steel). Distance C does not make reference to the object to be detected, but rather to the background. The object to be detected is detected within the switching distance.
D	Minimum dimension by which the sensor (sensing face) must protrude from the damping material (e.g. steel).
$8 \times S_n$	Installation opposite each other. Two identical sensors must be mounted at this minimum distance.

5.2.2 Installation Instructions for Sensors with weproTec

weproTec is the abbreviation for wenglor proximity switch technology, an innovative, patented wenglor technology for inductive sensors.

Inductive sensors with weproTec can be mounted very close to each other (→ installation dimension B1) or opposite one another ($1.5 \times S_n$). No reciprocal influence occurs among the sensors within the specified zones.

The installation instructions in accordance with the standard (see section Installation Instructions in Accordance with the Standard [▶ 12]) are also valid.

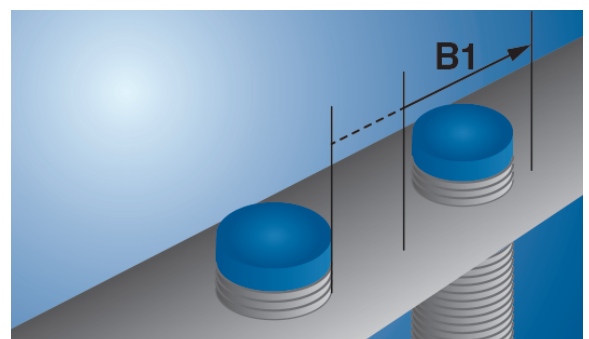
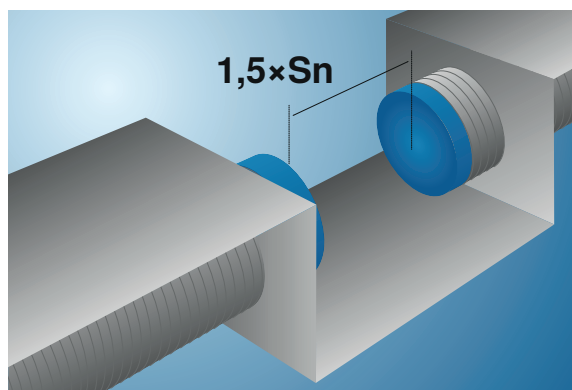

Installation dimension	Description
A	Minimum distance from sensor to damping material (e.g. steel).

B	<p>Minimum distance between two inductive sensors.</p> <p>This distance applies to installation in air. If the sensors are installed within an attenuating material (e.g. steel), this distance is reduced. Testing in the application is required in order to determine the exact distance.</p>
B1	<p>Additional minimum distance between two inductive sensors.</p> <p>This clearance applies to installation in air. If the sensors are installed within an attenuating material (e.g. steel), this distance is reduced. Testing in the application is required in order to determine the exact distance.</p>
C	<p>Minimum distance from the sensing face of the inductive sensor to the damping material (e.g. steel).</p> <p>Distance C does not make reference to the object to be detected, but rather to the background. The object to be detected is detected within the switching distance.</p>
D	<p>Minimum dimension by which the sensor (sensing face) must protrude from the damping material (e.g. steel).</p>
1.5 × Sn	<p>Installation opposite each other. Two identical sensors must be mounted at this minimum distance.</p>

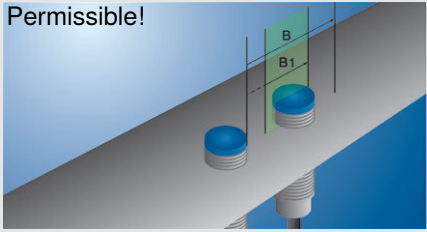
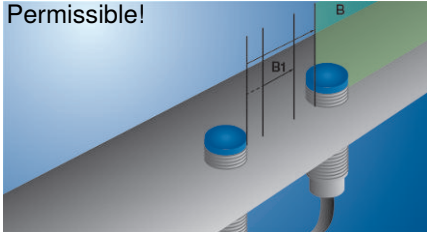
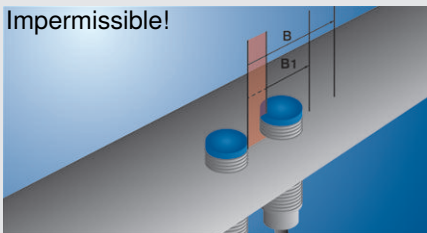
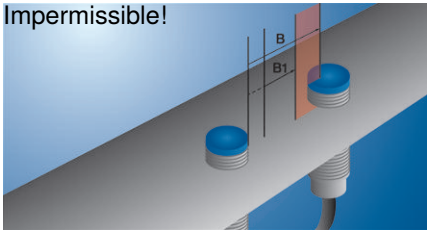
Installation variant	Description
<p>Permissible!</p> 	<p>Two sensors can be mounted next to each other in area B1.</p>
<p>Permissible!</p> 	<p>Two sensors can be mounted next to each other from installation dimension B.</p>
<p>Impermissible!</p> 	<p>Two sensors must not be mounted next to each other in front of area B1.</p>
<p>Impermissible!</p> 	<p>Two sensors must not be mounted in the area between B1 and B.</p>



Example: B1 starts at 0 mm

Installation B1 in mm: 0...60

- Installation A/B/C/D in mm: $x/110/x/x$
- Non-permissible range: 60...110 mm

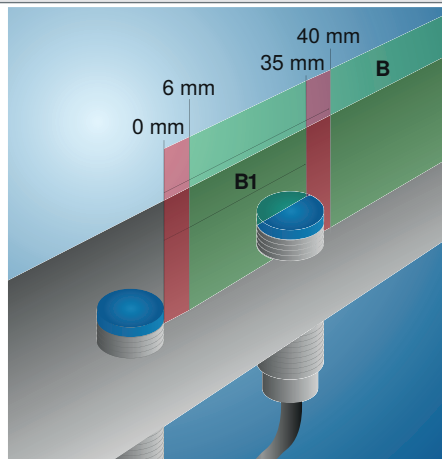

Example: B1 does not start at 0 mm

- Installation B1 in mm: 6...35

- Installation A/B/C/D in mm: $x/40/x/x$

5.2.3 Switching Distance

- The switching distance described in the technical data [► 9] is the nominal switching distance S_n according to the standard.
- The switching distance refers to a standard measuring plate (material: steel, thickness: 1 mm, side lengths: $3 \times S_n$ or outside diameter sensor).
- The switching distance according to the standard is further differentiated into:
 - Effective switching distance S_r
 - Useable switching distance S_u
 - Working distance S_a

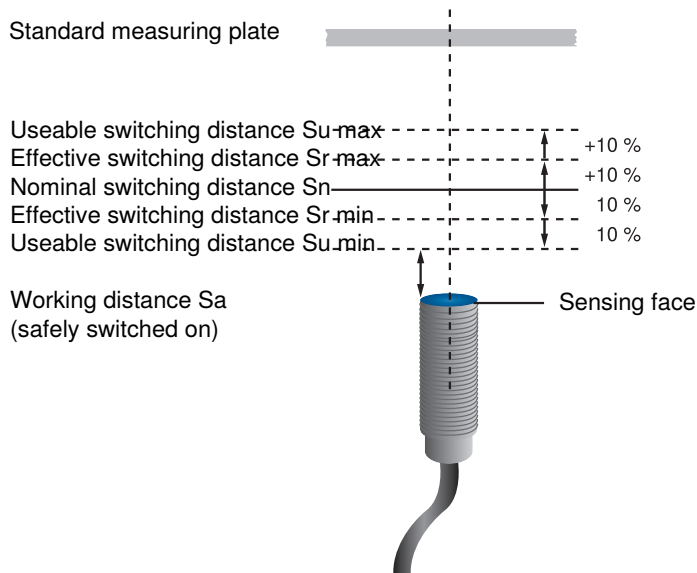

NOTICE

If the objects in the application are smaller than the standard measuring plate, the switching distance is also reduced.

The correction factor of the sensor for certain materials also influences the switching distance and must be observed.

The sensor should be mounted at a working distance S_a or less to the object.

5.3 Electrical Connection

- Wire the sensor in accordance with the connection diagram.
- Switch on the supply voltage (see section Technical Data [► 9]).
- If using IO-Link, connect the sensor to 18...30 V DC.
- If not using IO-Link, connect the sensor to 10...30 V DC.



DANGER

Risk of personal injury or property damage due to electric current.

Voltage-conducting parts may cause personal injury or damage to equipment.

→ The electric device may be connected by appropriately qualified personnel only.

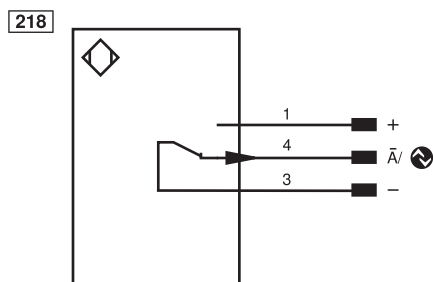

Legend

+	Supply Voltage +
-	Supply Voltage 0 V
~	Supply Voltage (AC Voltage)
A	Switching Output (NO)
\bar{A}	Switching Output (NC)
V	Contamination/Error Output (NO)
\bar{V}	Contamination/Error Output (NC)
E	Input (analog or digital)
T	Teach Input
Z	Time Delay (activation)
S	Shielding
RxD	Interface Receive Path
TxD	Interface Send Path
RDY	Ready
GND	Ground
CL	Clock
E/A	Output/Input programmable
	IO-Link
PoE	Power over Ethernet
IN	Safety Input
OSSD	Safety Output
Signal	Signal Output
BI_D+/-	Ethernet Gigabit bidirect. data line (A-D)
EN0_r542z	Encoder 0-pulse 0-0̄ (TTL)
PT	Platinum measuring resistor
nc	not connected
U	Test Input
\bar{U}	Test Input inverted
W	Trigger Input
W-	Ground for the Trigger Input
O	Analog Output
O-	Ground for the Analog Output
BZ	Block Discharge
AMV	Valve Output
a	Valve Control Output +
b	Valve Control Output 0 V
SY	Synchronization
SY-	Ground for the Synchronization
E+	Receiver-Line
S+	Emitter-Line
\pm	Grounding
SnR	Switching Distance Reduction
Rx+/-	Ethernet Receive Path
Tx+/-	Ethernet Send Path
Bus	Interfaces-Bus A(+)/B(-)
La	Emitted Light disengageable
Mag	Magnet activation
RES	Input confirmation
EDM	Contactors Monitoring
ENAr542z	Encoder A/ \bar{A} (TTL)
ENBr542z	Encoder B/ \bar{B} (TTL)
ENA	Encoder A
ENb	Encoder B
AMIN	Digital output MIN
AMAX	Digital output MAX
AOK	Digital output OK
SY In	Synchronization In
SY OUT	Synchronization OUT
OLT	Brightness output
M	Maintenance
rsv	reserved
Wire Colors according to IEC 60757	
BK	Black
BN	Brown
RD	Red
OG	Orange
YE	Yellow
GN	Green
BU	Blue
VT	Violet
GY	Grey
WH	White
PK	Pink
GNYE	Green/Yellow

5.4 Troubleshooting



INFORMATION

Required action in case of fault:

1. Shut down the machine.
2. Analyze and eliminate the cause of error with the aid of the diagnostics information.
3. If the error cannot be eliminated, please contact wenglor's support department.
4. Do not operate in case of indeterminate malfunctioning.
5. The machine must be shut down if the error cannot be definitively explained or properly eliminated.



DANGER

Risk of personal injury or property damage in case of non-compliance!

The system's safety function is disabled. Personal injury and damage to equipment may occur.

→ Required action as specified in case of fault.

6 Maintenance Instructions



NOTICE

This wenglor sensor is maintenance-free.

Cleaning and inspection of the plug connections at regular intervals are advisable.

Do not clean the sensor with solvents or cleaning agents that could damage the product.

The product must be protected against contamination during initial start-up.

7 Proper Disposal

wenglor sensoric GmbH does not accept the return of unusable or irreparable products. Respectively valid national waste disposal regulations apply to product disposal.

8 **Declarations of Conformity**

Declarations of conformity can be found on our website at www.wenglor.com in the product's separate download area.