

Operating Instructions

IR5D002

Inductive Ring Sensor



reddot winner 2025



EN



Table of Contents

1	General	3
1.1	Information Concerning these Instructions	3
1.2	Explanation of Symbols	3
1.3	Limitation of Liability	4
1.4	Copyrights	4
2	For Your Safety	5
2.1	Use for Intended Purpose	5
2.2	Use for Other than the Intended Purpose	5
2.3	Personnel Qualifications	5
2.4	Modification of Products	6
2.5	General Safety Precautions	6
2.6	Approvals and Protection Class	6
3	Technical Data	7
3.1	General Data	7
3.2	Housing Dimensions	8
3.3	Control Panel	8
3.4	Complementary Products	8
3.5	Scope of delivery	8
4	Transport and Storage	9
4.1	Transport	9
4.2	Storage	9
5	Installation and Electrical Connection	10
5.1	Installation	10
5.1.1	Installation Using the Soft Binder	10
5.1.2	Other Installation Options	11
5.1.3	Installation Instructions	12
5.1.4	Smallest Recognizable Object	12
5.2	Electrical Connection	12
5.3	Troubleshooting	13
6	Functions Overview	14
6.1	Function Description	14
6.1.1	Starting Up the Product as Supplied	14
6.1.2	Starting Up the Product with User-Defined Settings	14
6.2	LED Symbols	17
7	Setup via IO-Link	18
8	Maintenance Instructions	19
9	Proper Disposal	20
10	Declarations of Conformity	21

1 General

1.1 Information Concerning these Instructions

- These instructions make it possible to use the product safely and efficiently.
- These instructions are an integral part of the product and must be kept on hand for the entire duration of its service life.
- Local accident prevention regulations and national work safety regulations must be complied with as well.
- The product is subject to further technical development, and thus the information contained in these operating instructions may also be subject to change. The current version can be found at www.wenglor.com in the product's separate download area.



INFORMATION

The operating instructions must be read carefully before using the product and must be kept on hand for later reference.

1.2 Explanation of Symbols

- Safety precautions and warnings are emphasized by means of symbols and signal words.
- Safe use of the product is only possible if these safety precautions and warnings are adhered to.

The safety precautions and warnings are laid out in accordance with the following principle:

SIGNAL WORD

Type and source of danger!

Possible consequences in the event that the hazard is disregarded.

→ Measures for averting the hazard.

The meanings of the signal words, as well as the scope of the associated hazards, are listed below:



! DANGER

This signal word indicates a hazard with a high degree of risk which, if not avoided, results in death or severe injury.



! WARNING

This signal word indicates a hazard with a medium degree of risk which, if not avoided, may result in death or severe injury.



! CAUTION

This signal word indicates a hazard with a low degree of risk which, if not avoided, may result in minor or moderate injury.



NOTICE

This signal word draws attention to a potentially hazardous situation which, if not avoided, may result in property damage.



INFORMATION

Information draws attention to useful tips and suggestions, as well as information on efficient, error-free use.

1.3 Limitation of Liability

- The product has been developed in consideration of the current state-of-the-art technology, as well as applicable standards and guidelines. Subject to change without notice.
- A valid declaration of conformity can be accessed at www.wenglor.com in the product's separate download area.
- wenglor sensoric elektronische Geräte GmbH (hereinafter referred to as "wenglor") excludes all liability in the event of:
 - Non-compliance with the instructions
 - Use of the product for purposes other than those intended.
 - Use by untrained personnel.
 - Use of unapproved spare parts.
 - Unapproved modification of products.
- These operating instructions do not include any guarantees from wenglor with regard to the described procedures or specific product characteristics.
- wenglor assumes no liability for printing errors or other inaccuracies contained in these operating instructions unless wenglor was verifiably aware of such errors at the point in time at which the operating instructions were prepared.

1.4 Copyrights

- The contents of these instructions are protected by copyright law.
- All rights are reserved by wenglor.
- Commercial reproduction or any other commercial use of the provided content and information, in particular graphics and images, is not permitted without previous written consent from wenglor.

2 For Your Safety

2.1 Use for Intended Purpose

Inductive Ring Sensors for the Detection of Moving Parts

Inductive ring sensors are used to detect individual objects in conveyor technology applications.

A coil is arranged around the ring which generates a magnetic field. Metal parts inside the ring (e.g. screws, nuts, rivets) generate eddy currents in this magnetic field, which are detected by the sensor.

Dynamic functional principle:

Detected objects cause the output to switch for a defined time.

This Product Can Be Used in the Following Industry Sectors:

- Special-purpose mechanical engineering
- Heavy mechanical engineering
- Logistics
- Automotive industry
- Food industry
- Packaging industry
- Pharmaceuticals industry
- Plastics industry
- Woodworking industry
- Consumer goods industry
- Paper industry
- Electronics industry
- Glass industry
- Steel industry
- Aviation industry
- Chemicals industry
- Alternative energies
- Raw materials extraction

2.2 Use for Other than the Intended Purpose

- Not a safety component in accordance with 2006/42/EC (Machinery Directive).
- The product is not suitable for use in potentially explosive atmospheres.
- The product may be used only with accessories supplied or approved by wenglor, or in combination with approved products. A list of approved accessories and combination products can be found at www.wenglor.com on the product detail page.



DANGER

Risk of personal injury or property damage in case of use for other than the intended purpose!

Use for other than the intended purpose may lead to hazardous situations.

→ Observe instructions regarding use for intended purpose.

2.3 Personnel Qualifications

- Suitable technical training is a prerequisite.
- In-house electronics training is required.
- Trained personnel who use the product must have (permanent) access to the operating instructions.



DANGER

Risk of personal injury or property damage in case of incorrect initial start-up and maintenance!

Personal injury and damage to equipment may occur.

→ Adequate training and qualification of personnel

2.4 Modification of Products



DANGER

Risk of personal injury or property damage if the product is modified!

Personal injury and damage to equipment may occur. Noncompliance may result in loss of the CE and/or UKCA mark and voiding of the warranty.

→ Modification of the product is not permitted

2.5 General Safety Precautions



INFORMATION

These instructions are an integral part of the product and must be kept on hand for the entire duration of its service life.

In the event of possible changes, the current version of the operating instructions can be found at www.wenglor.com in the product's separate download area.

Read the operating instructions carefully before using the product.

Protect the sensor against contamination and mechanical influences.

2.6 Approvals and Protection Class

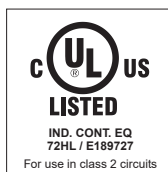

3 Technical Data

3.1 General Data

Technical Data	
Inductive Data	
Inside diameter	25.1 mm
Max. tube diameter	25 mm
Installation A/Bx/By/C in mm	0/42/100/10
Installation A/Bx/By/C in mm with frequency switching	0/0/0/10
Functional principle	Dynamic
Smallest recognizable object (Ø)	4 mm*
Correction Factors Stainless Steel V2A/CuZn/Al	1/1/1
Electrical Data	
Supply Voltage	10 ... 30 V DC
Current Consumption (U _b = 24 V)	< 25 mA
Object speed	0.1 ... 50 m/s
Response Time	< 300 µs
Ready-state delay	< 1.5 s
Switching Output Voltage Drop	1.5 V
Temperature Range	0 ... 60 °C
Short Circuit Protection	yes
Reverse Polarity and Overload Protection	yes
Switching Output/Switching Current	100 mA
Pulse extension	200 ms
Interface	IO-Link V1.1
Mechanical Data	
Connection	M8 × 1; 4-pin
Setting Method	Potentiometer/IO-Link
Hanger opening/closing cycles	Max. 100
Degree of Protection	IP54
Output Functions	
Output	NPN NO
Adjustable Parameters	
Output	PNP Push-pull NPN
Circuit	NO NC NC/NO
Pulse extension	5 ... 200 ms
Other parameters	Sensitivity Error indicator Frequency switching

* Relates to a steel ball when the setting potentiometer sens max. is selected

3.2 Housing Dimensions

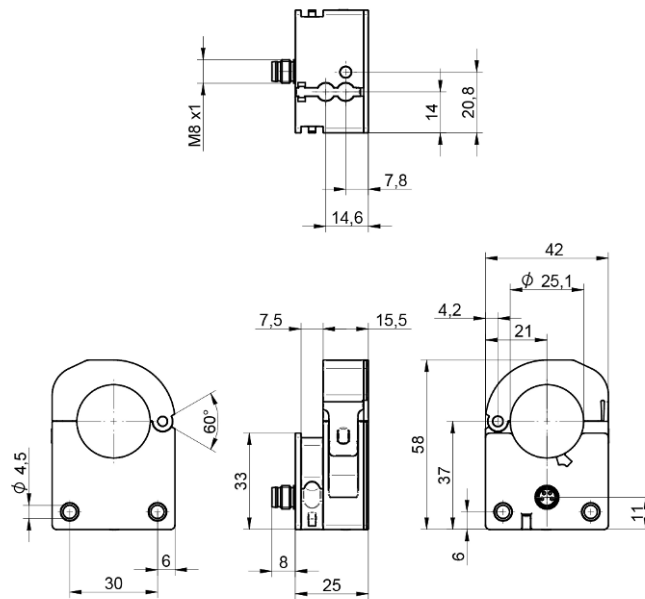

3.3 Control Panel

T19

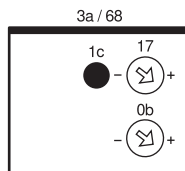

0b = pulse length adjuster

1c = status display/setup aid

3a = switching status indicator/error indicator

17 = sensitivity adjuster

68 = supply voltage indicator

3.4 Complementary Products

wenglor offers you the right connection and mounting technology as well as other accessories for your product. You can find this at www.wenglor.com on the product details page at the bottom.

3.5 Scope of delivery

- Sensor
- Soft binder
- Safety precaution

4 Transport and Storage

4.1 Transport

Upon receipt of shipment, the goods must be inspected for damage in transit. In the case of damage, conditionally accept the package and notify the manufacturer of the damage. Then return the device, making reference to damage in transit.

4.2 Storage

The following points must be taken into consideration with regard to storage:

- Do not store the product outdoors.
- Store the product in a dry, dust-free place.
- Protect the product against mechanical impacts.
- Protect the product against exposure to direct sunlight.



NOTICE

Risk of property damage in case of improper storage!

The product may be damaged.

→ Storage instructions must be complied with.

5 Installation and Electrical Connection

5.1 Installation

- Protect the product from contamination during installation.
- Relevant electrical and mechanical regulations, standards, and safety rules must be observed.
- Protect the product from mechanical impact.
- Ensure that the sensor is mechanically secure.
- Torque values must be observed (see section Technical Data [► 7]).



NOTICE

Risk of property damage in case of improper installation!

The product may be damaged!

→ Comply with installation instructions.



CAUTION

Risk of personal injury or property damage during installation!

Personal injury and damage to the product may occur.

→ Ensure a safe installation environment.

5.1.1 Installation Using the Soft Binder

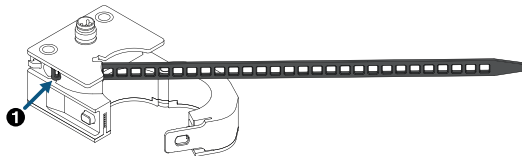

- Thread the soft binder into the feedthrough with the tip first until the ball at the end of the soft binder reaches the stop (1)
- Open the sensor's hanger

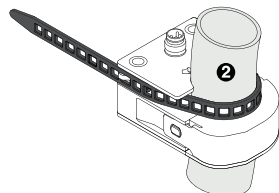

- Place the soft binder around the feed tube

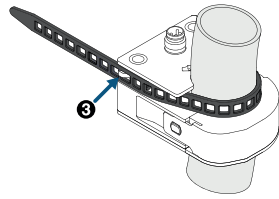

- Tighten the soft binder until the hose is in the active surface of the sensor, tension the soft binder and hook it onto the sensor (3)
- Close the sensor hanger

5.1.2 Other Installation Options

As a further installation option, the sensor has two holes that can be used to install the sensor using mounting technology. Please note that suitable mounting technology must be provided by the customer. The maximum tightening torque when using an M4 mounting screw is 2.9 Nm. In addition, the minimum installation distance to metal (cf. Technical Data) must be maintained.

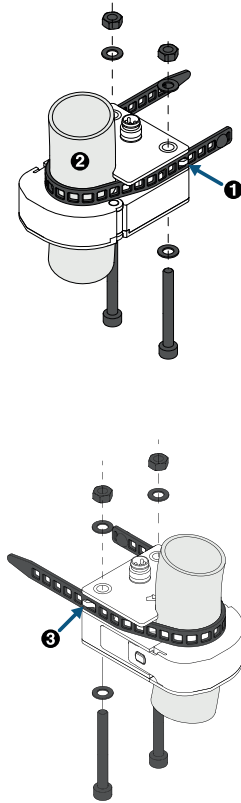

- Fasten the sensor with screws
- Hook in the soft binder on the hinge side (1), place it around the feed hose (2) and hook it in (3)

5.1.3 Installation Instructions

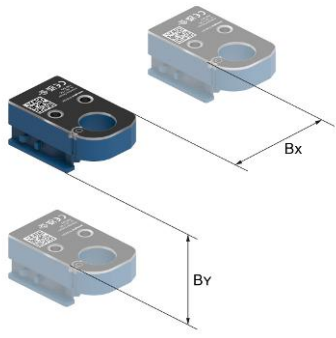
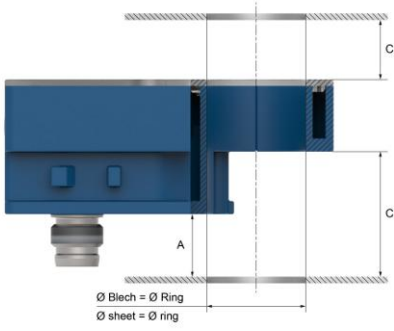
	<p>Adjacent devices alternating between alternative frequency / without alternative frequency</p> <table border="1"> <tr> <td></td> <td>IR5D002</td> </tr> <tr> <td>A</td> <td>0</td> </tr> <tr> <td>B_x</td> <td>0</td> </tr> <tr> <td>B_y</td> <td>0</td> </tr> <tr> <td>C</td> <td>10</td> </tr> </table>		IR5D002	A	0	B _x	0	B _y	0	C	10
	IR5D002										
A	0										
B _x	0										
B _y	0										
C	10										
	<p>Adjacent devices with the same frequency setting</p> <table border="1"> <tr> <td></td> <td>IR5D002</td> </tr> <tr> <td>A</td> <td>0</td> </tr> <tr> <td>B_x</td> <td>42</td> </tr> <tr> <td>B_y</td> <td>100</td> </tr> <tr> <td>C</td> <td>10</td> </tr> </table>		IR5D002	A	0	B _x	42	B _y	100	C	10
	IR5D002										
A	0										
B _x	42										
B _y	100										
C	10										

5.1.4 Smallest Recognizable Object

The smallest recognizable object indicates the minimum size of a steel ball that can be reliably detected by the sensor. The correction factor 1 can be used to derive the specified resolution with other materials such as stainless steel, brass, or aluminum.

5.2 Electrical Connection

- Wire the sensor in accordance with the connection diagram.
- Switch on the supply voltage (see section Technical Data [► 7]).
- If using IO-Link, connect the sensor to 18...30 V DC.
- If not using IO-Link, connect the sensor to 10...30 V DC.
- Alternative frequency activated: Pin 2 to +
- Alternative frequency deactivated: Pin 2 to 0/open



DANGER

Risk of personal injury or property damage due to electric current.

Voltage-conducting parts may cause personal injury or damage to equipment.

→ The electric device may be connected by appropriately qualified personnel only.

275

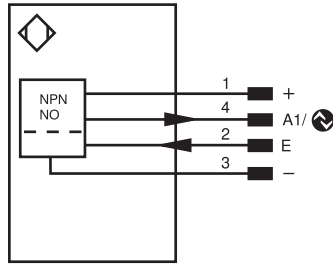

Legend

+	Supply Voltage +
-	Supply Voltage 0 V
~	Supply Voltage (AC Voltage)
A	Switching Output (NO)
Ā	Switching Output (NC)
V	Contamination/Error Output (NO)
Ṽ	Contamination/Error Output (NC)
E	Input (analog or digital)
T	Teach Input
Z	Time Delay (activation)
S	Shielding
RxD	Interface Receive Path
TxD	Interface Send Path
RDY	Ready
GND	Ground
CL	Clock
E/A	Output/Input programmable
	IO-Link
PoE	Power over Ethernet
IN	Safety Input
QSSD	Safety Output
Signal	Signal Output
Bl_D+/-	Ethernet Gigabit bidirect. data line (A-D)
EN0rs42z	Encoder 0-pulse 0-0̄ (TTL)

PT	Platinum measuring resistor
nc	not connected
U	Test Input
Ū	Test Input inverted
W	Trigger Input
W-	Ground for the Trigger Input
O	Analog Output
O-	Ground for the Analog Output
BZ	Block Discharge
AWV	Valve Output
a	Valve Control Output +
b	Valve Control Output 0 V
SY	Synchronization
SY-	Ground for the Synchronization
E+	Receiver-Line
S+	Emitter-Line
⊕	Grounding
SnR	Switching Distance Reduction
Rx+/-	Ethernet Receive Path
Tx+/-	Ethernet Send Path
Bus	Interfaces-Bus A(+)/B(-)
La	Emitted Light disengageable
Mag	Magnet activation
RES	Input confirmation
EDM	Contactors Monitoring

ENArS42z	Encoder A/Ā (TTL)
ENBRs42z	Encoder B/B̄ (TTL)
ENA	Encoder A
ENB	Encoder B
AMIN	Digital output MIN
AMAX	Digital output MAX
AOK	Digital output OK
SY In	Synchronization In
SY OUT	Synchronization OUT
OLt	Brightness output
M	Maintenance
rsv	reserved
Wire Colors according to IEC 60757	
BK	Black
BN	Brown
RD	Red
OG	Orange
YE	Yellow
GN	Green
BU	Blue
VT	Violet
GY	Grey
WH	White
PK	Pink
GNYE	Green/Yellow

5.3 Troubleshooting

Error	Possible cause	Elimination
Error	Short circuit	Check the electrical wiring and eliminate the short circuit
	Mechanical damage to the coil	Replace the sensor
	Hanger not closed	Close the hanger



INFORMATION

Required action in case of fault:

1. Shut down the machine.
2. Analyze and eliminate the cause of error with the aid of the diagnostics information.
3. If the error cannot be eliminated, please contact wenglor's support department.
4. Do not operate in case of indeterminate malfunctioning.
5. The machine must be shut down if the error cannot be definitively explained or properly eliminated.



DANGER

Risk of personal injury or property damage in case of non-compliance!

The system's safety function is disabled. Personal injury and damage to equipment may occur.

→ Required action as specified in case of fault.

6 Functions Overview

This section explains the sensor's functions and LED symbols in more detail.

6.1 Function Description

This function description refers to a setting on the potentiometer of the sensor.

6.1.1 Starting Up the Product as Supplied

The device is ready for use and can be put into operation.

The sensitivity of the sensor is preset to detect typical objects.

The time delay setting is set to 200 ms (turn all the way to the right).

6.1.2 Starting Up the Product with User-Defined Settings

When adjusting settings on the device, a distinction can be made between setting the sensitivity and the time delay.

6.1.2.1 Setting the Sensitivity to Object Size

Turn the potentiometer all the way to the left 



LED symbols according to section LED Symbols [▶ 17]

Guide the object to be detected through the ring (active surface) of the sensor

If the setup aid is off or flashing, turn the potentiometer clockwise in the direction of (+)  until the setup aid illuminates continuously



6.1.2.2 Adjusting the Off-Delay

The sensors are delivered from the factory with the maximum off-delay.

1. Turn the potentiometer TIME counterclockwise  to the desired time delay.

Dynamic



LED symbols according to section — FEHLENDER LINK —

The on-delay is immediately active.

See also

LED Symbols [► 17]

6.1.2.3 Setting the Pulse Length

The pulse length adjuster can be used to set the time until the signal drops at the output between 5 ms and 200 ms.

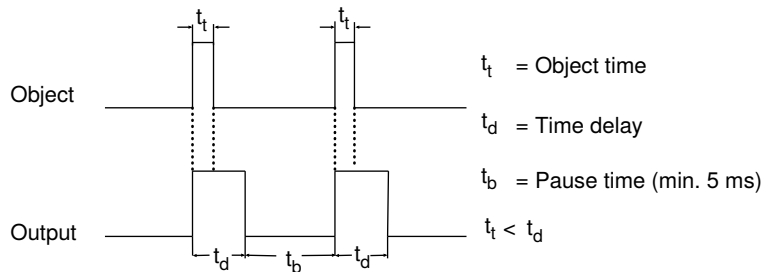

If the object is shorter than the set pulse length within the active surface, the switching signal is maintained until the preset off-delay is reached.

6.1.2.4 Activating Alternative Frequency

The alternative frequency can be activated either via the cable connection (see Electrical Connection [► 12]) or via IO-Link.

The activated working frequency enables another sensor for which this setting is deactivated to be operated in the immediate vicinity without the sensors interfering with each other.

6.1.2.5 Using Counter Functions

The counter functions can be parameterized via IO-Link and read out via the “Counter Output Status”. To do so, the Config must be switched to the desired mode. If an event is to be parameterized on switching output A2 in relation to the counter functions (Compare mode 1 to 3 and Overflow/underflow mode), the input of pin 2 must be set to output 2 “Counter” and to the desired output function, such as PNP, NPN or push-pull.

Terminology

Signal:	Is present if an object has been detected
Counter:	Counter that counts if a signal is present
Counter Compare Value:	Configurable value at which an event occurs when it is reached
Counter Max Value (Period):	Configurable value that specifies the period length in relation to the counter
Perioden Counter:	Indicates the number of periods
Counter Output Status:	Indicates the switching behavior of the counter

Configurable Counter Modes

- Only counts
- Compare mode 1
- Compare mode 2
- Compare mode 3
- Overflow/underflow mode

Counting can be up or down in all modes.

Only counts

In this mode, the device counts the detected objects. Figures 1 and 2 show an example with a “Counter Max Value (Period)” of 5.



Illustration 1: Only counts function - counting up

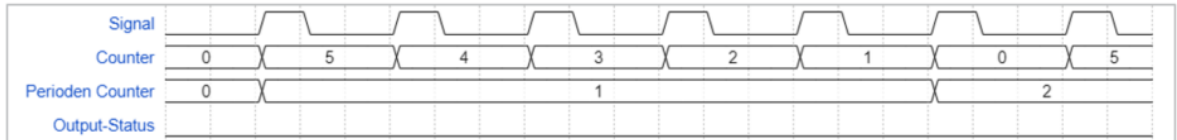

Illustration 2: Only counts function - counting down

Compare mode 1

In this mode, the “Counter Output” is switched when the comparison value is reached. If the set period value is reached, this value is maintained, and the “Counter Output” switches back to false. Figures 3 and 4 show the “Compare Mode 1” function with a “Counter Compare Value” of 3 and a “Counter Max Value (Period)” of 5.

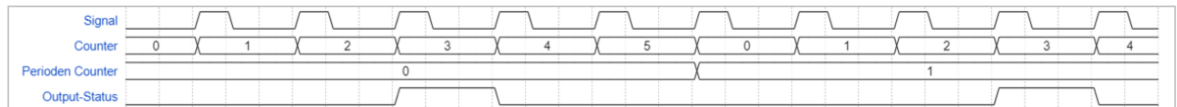

Illustration 3: Compare mode 1 function - counting up

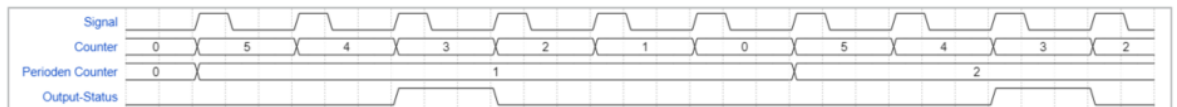

Illustration 4: Compare mode 1 function - counting down

Compare mode 2

As soon as the set comparison value is reached, the “Counter Output Status” is switched until the end of the period is reached. Figures 5 and 6 explain the “Compare mode 2” with a “Counter Compare Value” of 3 and a “Counter Max Value (Period)” of 5.

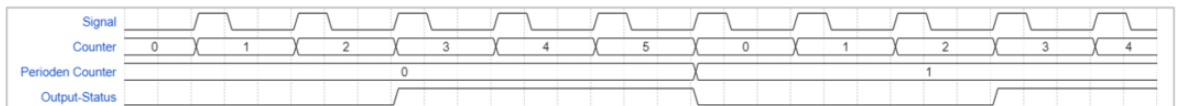

Illustration 5: Compare mode 2 function - counting up

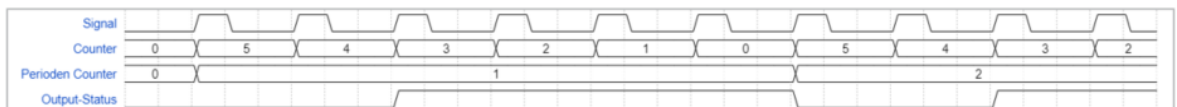

Illustration 6: Compare mode 2 function - counting down

Compare mode 3

In this mode, the “Counter Output Status” is switched when the comparison value is reached. If the set period value is reached, this value is maintained, and the “Counter Output Status” switches back to false. Figures 7 and 8 show the function with a “Counter Compare Value” of 3 and a “Counter Max Value (Period)” of 5.

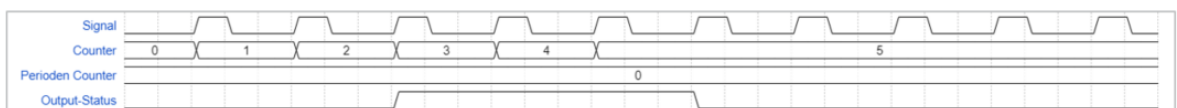

Illustration 7: Compare mode 3 function - counting up

Please note: For this function, a value must already be set on the counter when counting down.

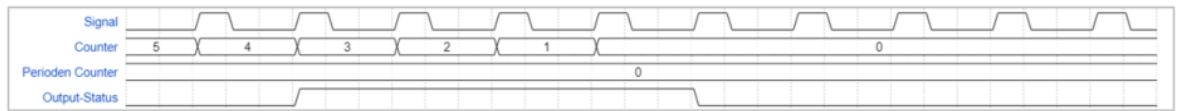

Illustration 8: Compare mode 3 function - counting down

Additionally, in this mode the Counter can be reset by the “One Pulse Status” (“Reset or no event”). A reading can also indicate whether the comparison value has already been reached (“Event detected”).

Overflow/underflow mode

With this setting, the “Counter Output Status” is always switched if the period end is exceeded or fallen short of. Figures 9 and 10 show the function with a “Counter Compare Value” of 3 and a “Counter Max Value (Period)” of 5.



Illustration 9: Overflow/underflow mode function - counting up

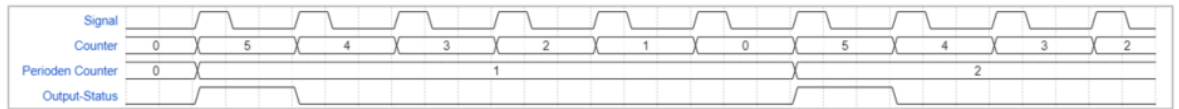

Illustration 10: Overflow/underflow mode function - counting down

6.2 LED Symbols

Setup display	Switching status indicator/supply voltage indicator	Cause
🟢 Green*	💡 Blue	No object present yet
🟢 Green**	💡 Blue	Object was not reliably detected
🟢 Green	💡 Blue	Object was reliably detected
🟡 Green	💡 Blue	Object was not detected
-	🔴 Red	Hanger not closed, short circuit at the output
-	🔴 Red	The device has an error. Information on how to remedy the error can be found in the troubleshooting section
🟢 Green	💡 Yellow	Switching output active
-	💡 Blue**	Device has been set to factory settings/alternative frequency switching has been activated

○ Not lit up

🔴 Flashing

💡 Permanently lit up

* Flashing behavior: 1 Hz 50 ms On to 950 ms Off

** Flashing behavior: 1 Hz 500 ms On to 500 ms Off

See also

📖 Troubleshooting [▶ 13]

7 Setup via IO-Link

Process and parameter data can be found in the interface protocol at: www.wenglor.com - Products - Enter the desired product number as a search term, then click on "Downloads" on the product page.

Process Data:

- Counter
- Object size
- Object width (how long the object was detected)
- Error indicator
- Warning
- Switching status A1
- Switching status A2

Parameter Data:

- Potentiometer lock
- Parametrization of sensitivity
- Parametrization of pulse length
- Output function A1
- Output function A2
- Alternative frequency

8 Maintenance Instructions



NOTICE

This wenglor product is maintenance-free.

Cleaning and inspection of the plug connections at regular intervals are advisable.

Do not clean the product with solvents or cleaning agents that could damage the product.

The product must be protected against contamination during initial start-up.

9 Proper Disposal

wenglor sensoric GmbH does not accept the return of unusable or irreparable products. Respectively valid national waste disposal regulations apply to product disposal.

10 **Declarations of Conformity**

Declarations of conformity can be found on our website at www.wenglor.com in the product's separate download area.