

Operating Instructions

U1KT002

Distance Sensor



EN



Table of Contents

1	General	3
1.1	Information Concerning these Instructions	3
1.2	Explanation of Symbols	3
1.3	Limitation of Liability	4
1.4	Copyrights	4
2	For Your Safety	5
2.1	Use for Intended Purpose	5
2.2	Use for Other than the Intended Purpose	5
2.3	Personnel Qualifications	5
2.4	Modification of Products	6
2.5	General Safety Precautions	6
2.6	Approvals and Protection Class	6
3	Technical Data	7
3.1	General Data	7
3.2	Default Settings	8
3.3	Mode-Dependent Data	8
3.4	Sonic Cone Diagrams	9
3.5	Housing Dimensions	10
3.6	Control Panel	11
3.7	Complementary Products	11
3.8	Layout	11
3.9	Scope of delivery	11
4	Transport and Storage	12
4.1	Transport	12
4.2	Storage	12
5	Installation and Electrical Connection	13
5.1	Installation	13
5.2	Electrical Connection	14
6	Settings	15
6.1	Foreground Teach-In	15
6.2	Setting via IO-Link and wTeach2	15
6.2.1	Window teach-in	15
6.2.2	Through-Beam Sensor Operating Mode	16
6.2.3	Synchronous Mode of Operation	17
6.2.4	“Mute” Mode of Operation	18
6.2.5	Pin Functions I/O2	18
6.2.6	External Temperature Compensation	19
6.2.7	Filter	19
7	Maintenance Instructions	20
8	Proper Disposal	21
9	Declarations of Conformity	22

1 General

1.1 Information Concerning these Instructions

- These instructions make it possible to use the product safely and efficiently.
- These instructions are an integral part of the product and must be kept on hand for the entire duration of its service life.
- Local accident prevention regulations and national work safety regulations must be complied with as well.
- The product is subject to further technical development, and thus the information contained in these operating instructions may also be subject to change. The current version can be found at www.wenglor.com in the product's separate download area.



INFORMATION

The operating instructions must be read carefully before using the product and must be kept on hand for later reference.

1.2 Explanation of Symbols

- Safety precautions and warnings are emphasized by means of symbols and signal words.
- Safe use of the product is only possible if these safety precautions and warnings are adhered to.

The safety precautions and warnings are laid out in accordance with the following principle:

SIGNAL WORD

Type and source of danger!

Possible consequences in the event that the hazard is disregarded.

→ Measures for averting the hazard.

The meanings of the signal words, as well as the scope of the associated hazards, are listed below:



DANGER

This signal word indicates a hazard with a high degree of risk which, if not avoided, results in death or severe injury.



WARNING

This signal word indicates a hazard with a medium degree of risk which, if not avoided, may result in death or severe injury.



CAUTION

This signal word indicates a hazard with a low degree of risk which, if not avoided, may result in minor or moderate injury.



NOTICE

This signal word draws attention to a potentially hazardous situation which, if not avoided, may result in property damage.



INFORMATION

Information draws attention to useful tips and suggestions, as well as information on efficient, error-free use.

1.3 Limitation of Liability

- The product has been developed in consideration of the current state-of-the-art technology, as well as applicable standards and guidelines. Subject to change without notice.
- A valid declaration of conformity can be accessed at www.wenglor.com in the product's separate download area.
- wenglor sensoric elektronische Geräte GmbH (hereinafter referred to as "wenglor") excludes all liability in the event of:
 - Non-compliance with the instructions
 - Use of the product for purposes other than those intended.
 - Use by untrained personnel.
 - Use of unapproved spare parts.
 - Unapproved modification of products.
- These operating instructions do not include any guarantees from wenglor with regard to the described procedures or specific product characteristics.
- wenglor assumes no liability for printing errors or other inaccuracies contained in these operating instructions unless wenglor was verifiably aware of such errors at the point in time at which the operating instructions were prepared.

1.4 Copyrights

- The contents of these instructions are protected by copyright law.
- All rights are reserved by wenglor.
- Commercial reproduction or any other commercial use of the provided content and information, in particular graphics and images, is not permitted without previous written consent from wenglor.

2 For Your Safety

2.1 Use for Intended Purpose

Ultrasonic sensors emit pulsed ultrasonic waves at a certain frequency using air as a transmitting medium. Parameters can be taught into the sensors shown here via an input or IO-Link. The output is switched when the preselected switching point is reached. With some variants, the measured values can be output as an analog value. In addition, the measured value can be read out via IO-Link 1.1. The sensors can be used in both reflex mode and through-beam mode.

This product can be used in the following industry sectors:

- Special-purpose mechanical engineering
- Heavy mechanical engineering
- Logistics
- Automotive industry
- Food industry
- Packaging industry
- Pharmaceuticals industry
- Plastics industry
- Woodworking industry
- Consumer goods industry
- Paper industry
- Electronics industry
- Glass industry
- Steel industry
- Aviation industry
- Chemicals industry
- Alternative energies
- Raw materials extraction

2.2 Use for Other than the Intended Purpose

- Not a safety component in accordance with 2006/42/EC (Machinery Directive).
- The product is not suitable for use in potentially explosive atmospheres.
- The product may be used only with accessories supplied or approved by wenglor, or in combination with approved products. A list of approved accessories and combination products can be found at www.wenglor.com on the product detail page.



DANGER

Risk of personal injury or property damage in case of use for other than the intended purpose!

Use for other than the intended purpose may lead to hazardous situations.

→ Observe instructions regarding use for intended purpose.

2.3 Personnel Qualifications

- Suitable technical training is a prerequisite.
- In-house electronics training is required.
- Trained personnel who use the product must have (permanent) access to the operating instructions.



DANGER

Risk of personal injury or property damage in case of incorrect initial start-up and maintenance!

Personal injury and damage to equipment may occur.

→ Adequate training and qualification of personnel

2.4 Modification of Products



DANGER

Risk of personal injury or property damage if the product is modified!

Personal injury and damage to equipment may occur. Noncompliance may result in loss of the CE mark and voiding of the warranty.

→ Modification of the product is not permitted

2.5 General Safety Precautions



INFORMATION

These instructions are an integral part of the product and must be kept on hand for the entire duration of its service life.

In the event of possible changes, the current version of the operating instructions can be found at www.wenglor.com in the product's separate download area.

Read the operating instructions carefully before using the product.

Protect the sensor against contamination and mechanical influences.

2.6 Approvals and Protection Class

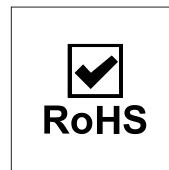
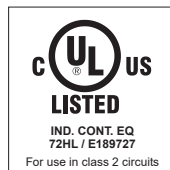

3 Technical Data

3.1 General Data

Technical Data	
Ultrasound Data	
Working range, reflex sensor	30 ... 400 mm
Working range, through-beam sensor	30 ... 800 mm
Setting Range	30...400 mm
Reproducibility maximum	4 mm
Linearitätsabweichung	4 mm
Resolution	0,5 mm
Ultrasonic Frequency	325 kHz
Opening Angle	< 12 °
Service Life (T = +25 °C)	100000 h
Switching Hysteresis	1 % *
Electrical Data	
Supply Voltage	18 ... 30 V DC
Stromaufnahme (Ub = 24 V)	< 20 mA
Switching frequency, reflex sensor	30 Hz
Switching frequency, through-beam sensor	70 Hz
Response time, reflex sensor	17 ms
Response time, through-beam sensor	8 ms
Temperature Range	-30 ... 60 °C
Number of Switching Outputs	2
Switching Output Voltage Drop	< 2,5 V
Switching Output/Switching Current	100 mA
Synchronous Mode	Max. 40 Sensors
Short Circuit Protection	yes
Reverse Polarity Protection	yes
Überlastsicher	yes
Lockable	yes
Interface	IO-Link V1.1
Data Storage	yes
Protection Class	III
Mechanical Data	
Setting Method	Teach-in
Housing Material	Plastic
Degree of Protection	IP68
Connection	M8 × 1; 4-pin
Technical Safety Data	
MTTFd (EN ISO 13849-1)	1106,71 a
Output Function in Default Setting	
Output function Pin 2	NPN
Output function Pin 4	NPN
Switching function Pin 2	NO
Switching function Pin 4	NO

* Relative to switching distance, at least 2 mm

3.2 Default Settings

Technical Data	U1KT002
Sensor operating mode	Normal
Filter	0
Sonic cone	Standard
Process data type	Outputs and measured value
Temperature mode	Internal
A1 Pin function	Switching output
A2 Pin Function	Switching output
A1 Teach Mode	Foreground
A1, PNP/NPN	NPN
A1 NO/NC	NO
A1 Switching Point	400 mm
A1 Additional hysteresis	0 mm
A2 Teach-Mode	Foreground
A2 PNP/NPN	NPN
A2 NO/NC	NO
A2 Switching Point	400 mm
A2 Additional hysteresis	0 mm

3.3 Mode-Dependent Data

Some technical data depend on the mode set. Depending on the setting, the following data are obtained:

Reflex-Mode Operation

Filter value	Switching frequency in Hz	Response time in ms
0	30	17
1	24	20.4
2	21	23.8
3	18	27.2
4	16	30.6
5	14	34
6	13	37.4
7	12	40.8
8	11	44.2
9	10	47.6
10	9.5	51
11	9	54.4
12	8.5	57.8
13	8.5	57.8
14	8.5	57.8
15	8.5	57.8
16	3	125
17	1.5	250
18	0.4	1,000
19	0.2	2,000
20	0.15	3,000

Through-Beam Mode

Filter value	Switching frequency in Hz	Response time in ms
0	70	7.1
1	47	10.7
2	38	13.3
3	31	16
4	27	18.7
5	23	21.3
6	20	24
7	18	26.7
8	17	29.3
9	15.5	32
10	14	34.7
11	13	37.3
12	12.5	40
13	11.5	42.7
14	11	45.3
15	11	45.3
16	3	125
17	1.5	250
18	0.4	1,000
19	0.2	2,000
20	0.15	3,000

The specified switching frequency and response time correspond to the maximum duration including the interference filter. A detailed description of the filter function can be found in section Filter [► 19].

3.4 Sonic Cone Diagrams

Measurement of the sonic cone on a 100 × 100 mm plate

Characteristic curves show the position of the center or the front edge of the measured object (100 × 100 mm plate) at the time of switching.

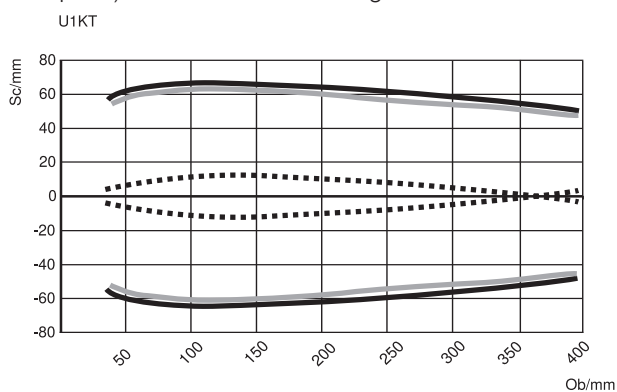

Measurement of the sonic cone on a rod with a diameter of 25 mm

Characteristic curves show the position of the center or the front edge of the measured object (Ø 25 mm rod) at the time of switching.

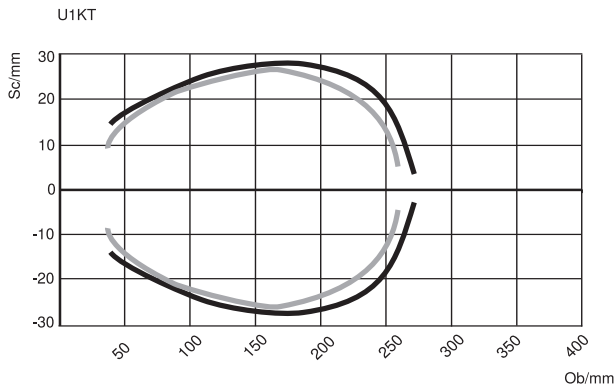

Ob = object

Sc = sonic cone

- Standard sonic cone (center of the measured object)
- - - Extra-narrow sonic cone (center of the measured object)
- Standard sonic cone (front edge of the measured object)



INFORMATION

Please note that using multiple ultrasonic sensors can cause reciprocal influence.

3.5 Housing Dimensions

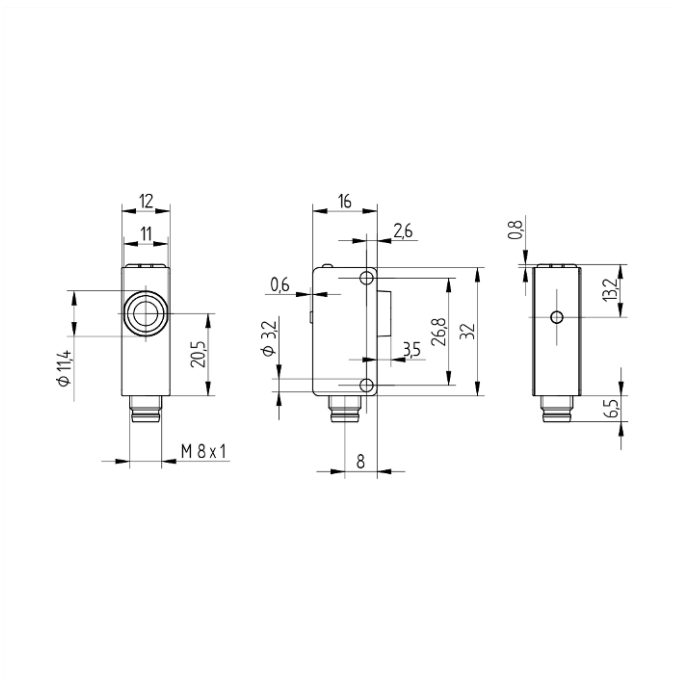

Dimensions specified in mm (1 mm = 0.03937 Inch)

3.6 Control Panel

A 23

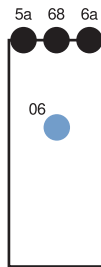

06 = teach-in key

5a = switching status display, O1

68 = supply voltage indicator

6a = switching status indicator, O2

3.7 Complementary Products

wenglor offers you the right connection and mounting technology as well as other accessories for your product. You can find this at www.wenglor.com on the product details page at the bottom.

3.8 Layout

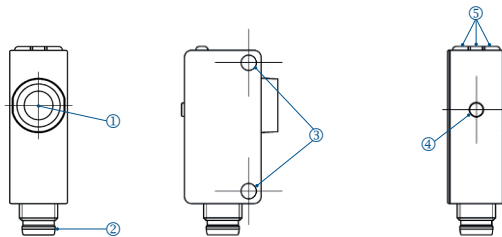

① = sensing face

② = connector plug

③ = mounting holes

④ = teach-in key

⑤ = indicator LEDs

3.9 Scope of delivery

- Sensor
- Safety precaution

4 Transport and Storage

4.1 Transport

Upon receipt of shipment, the goods must be inspected for damage in transit. In the case of damage, conditionally accept the package and notify the manufacturer of the damage. Then return the device, making reference to damage in transit.

4.2 Storage

The following points must be taken into consideration with regard to storage:

- Do not store the product outdoors.
- Store the product in a dry, dust-free place.
- Protect the product against mechanical impacts.
- Protect the product against exposure to direct sunlight.



NOTICE

Risk of property damage in case of improper storage!

The product may be damaged.

→ Storage instructions must be complied with.

5 Installation and Electrical Connection

5.1 Installation

- Protect the product from contamination during installation.
- Observe all applicable electrical and mechanical regulations, standards and safety rules.
- Protect the product against mechanical influences.
- Make sure that the sensor is mounted in a mechanically secure fashion.
- Specified torque values must be complied with (see section Technical Data [▶ 7]).
- If the object has smooth surfaces, the angle between the axis of the sound waves and the surface of the object should be $90^\circ \pm 3^\circ$. The angle can be considerably larger in the case of rough object surfaces.
- The active surface of the sensor may not contact any other machine parts.



INFORMATION

Observe the blind spot.

In the area between the sensor's active surface and the beginning of its working range, correct functioning of the sensor is not assured. No objects may be located in this area.

	Object position			Switching output / Switch LED	Error output / Error LED indicator	Measured value IO-Link
Working range (30...450 mm)		x		Defined	Defined	Defined
Blind spot (0...30 mm)	x			Undefined	Undefined	Undefined
Above Working range (> 450 mm)			x	Defined	Defined	Defined



NOTICE

Risk of property damage in case of improper installation!

The product may be damaged!

→ Comply with installation instructions.



CAUTION

Risk of personal injury or property damage during installation!

Personal injury and damage to the product may occur.

→ Ensure a safe installation environment.

5.2 Electrical Connection

- Wire the sensor in accordance with the connection diagram.
- Switch on the supply voltage (see section Technical Data [► 7]).
- If using IO-Link, connect the sensor to 18...30 V DC.



DANGER

Risk of personal injury or property damage due to electric current.

Voltage-conducting parts may cause personal injury or damage to equipment.

→ The electric device may be connected by appropriately qualified personnel only.

373

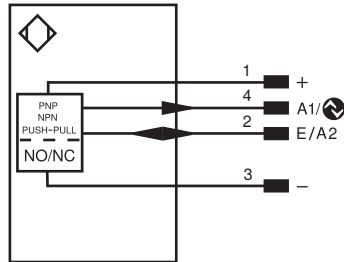

Legend

+	Supply Voltage +
-	Supply Voltage 0 V
~	Supply Voltage (AC Voltage)
A	Switching Output (NO)
\bar{A}	Switching Output (NC)
V	Contamination/Error Output (NO)
\bar{V}	Contamination/Error Output (NC)
E	Input (analog or digital)
T	Teach Input
Z	Time Delay (activation)
S	Shielding
RxD	Interface Receive Path
TxD	Interface Send Path
RDY	Ready
GND	Ground
CL	Clock
E/A	Output/Input programmable
	IO-Link
PoE	Power over Ethernet
IN	Safety Input
QSSD	Safety Output
Signal	Signal Output
Bi_D+/-	Ethernet Gigabit bidirect. data line (A-D)
EN0rs422	Encoder 0-pulse 0-0 (TTL)

PT	Platinum measuring resistor
nc	not connected
U	Test Input
\bar{U}	Test Input inverted
W	Trigger Input
W-	Ground for the Trigger Input
O	Analog Output
O-	Ground for the Analog Output
BZ	Block Discharge
AwV	Valve Output
a	Valve Control Output +
b	Valve Control Output 0 V
SY	Synchronization
SY-	Ground for the Synchronization
E+	Receiver-Line
S+	Emitter-Line
\perp	Grounding
SnR	Switching Distance Reduction
Rx+/-	Ethernet Receive Path
Tx+/-	Ethernet Send Path
Bus	Interfaces-Bus A(+)/B(-)
La	Emitted Light disengageable
Mag	Magnet activation
RES	Input confirmation
EDM	Contacting Monitoring

ENAr5422	Encoder A/ \bar{A} (TTL)
ENBr5422	Encoder B/ \bar{B} (TTL)
ENA	Encoder A
ENB	Encoder B
AMIN	Digital output MIN
AMAX	Digital output MAX
AOK	Digital output OK
SY In	Synchronization In
SY OUT	Synchronization OUT
OLt	Brightness output
M	Maintenance
rsv	reserved
Wire Colors according to IEC 60757	
BK	Black
BN	Brown
RD	Red
OG	Orange
YE	Yellow
GN	Green
BU	Blue
VT	Violet
GY	Grey
WH	White
PK	Pink
GNYE	Green/Yellow

6 Settings

The sensor can be set via external teach-in, IO-Link and wTeach2. The different setting options are outlined below.

6.1 Foreground Teach-In

The switching distance to the object can be taught in for both outputs by pressing the teach-in key on the sensor (foreground teach-in).

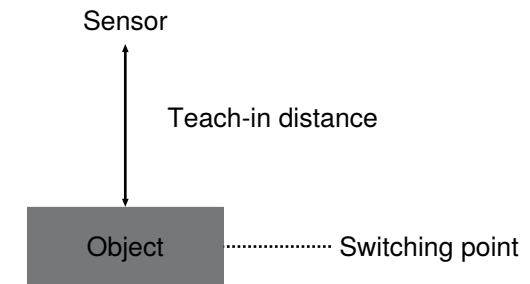

Foreground Teach-In for Switching Output 1

1. Install the sensor in accordance with the installation instructions.
2. Position the object in front of the sensor.
3. Press and hold the teach-in key until switching status indicator LED O1 starts to flash.
4. Release the teach-in key after 2 seconds.
5. The distance is taught in, and LED O1 lights up to confirm successful teach-in.

Foreground Teach-In for Switching Output 2

1. Install the sensor in accordance with the installation instructions.
2. Position the object in front of the sensor.
3. Press and hold the teach-in key until switching status indicator LED O2 starts to flash.
4. Release the teach-in key after 5 seconds.
5. The distance is taught in, and LED O2 lights up to confirm successful teach-in.



INFORMATION

If there's no object within the measuring range, switching distance is set to the end of the setting range.

6.2 Setting via IO-Link and wTeach2

The sensors can exchange parameters and process data via IO-Link. The parameters can be used to make many additional settings on the device. The process data transmit cyclical data and condition monitoring.

To this end, the sensor is connected to a suitable IO-Link master (see product detail page/complementary products). The interface protocol and the IODD can be found at www.wenglor.com in the download area for the respective product.

For information on installing and connecting the wTeach2 software and its structure, as well as information on the general functions, see the wTeach2 operating instructions. They can be found online in the download area at www.wenglor.com under order number DNNF005.

6.2.1 Window teach-in

In addition to foreground teach-in (default setting), there is also a window teach-in option for the switching output:

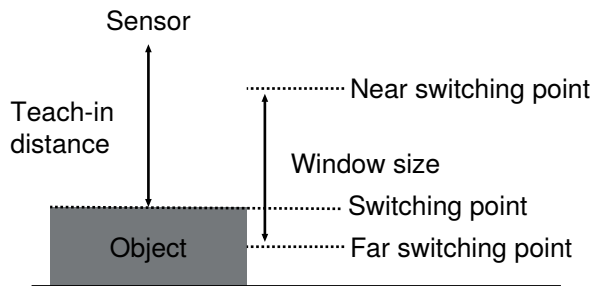

1. Enter or teach in the far switching point.
2. Enter or teach in the near switching point.
3. The sensor is switched when an object is located between the two switching points.



INFORMATION

The far switching point must be greater than the near switching point.

6.2.2 Through-Beam Sensor Operating Mode

In addition to the reflex mode (default setting), a through-beam operating mode is also available. Two sensors are required to this end.

1. Set up one sensor as an emitter.
2. Set up another sensor as a receiver.
3. If the receiver is operated as a normally closed contact, it is switched when an object is located between the emitter and the receiver.

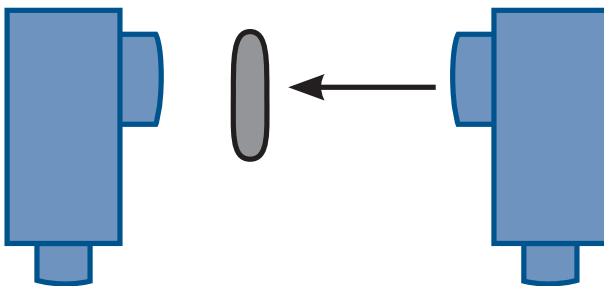

Technical Data in Through-Beam Mode:

Range:	1...800 mm
Switching frequency:	70 Hz
Response time:	8 ms



INFORMATION

1. The sonic cone setting on the receiver determines the sensitivity of the through-beam sensor:
2. The maximum range can be achieved with the standard sonic cone.
3. Set the sonic cone to narrow at the receiver, in order to detect even small objects between the emitter and the receiver.



INFORMATION

Sensors in reflex and through-beam mode must not be combined!

Differentiation between one and two layers of thin material such as paper or foil is possible in the through-beam operating mode.

1. Position the emitter and the receiver a short distance from each other.
2. Adjust the distance between the emitter and the receiver so that the receiver continues to switch for one layer but not for two.



INFORMATION

1. Teach-in via the teach-in key is not possible in the through-beam operating mode.
2. Adjustments can be made by changing the distance between the emitter and the receiver and with the help of the sonic cone settings at the receiver.

6.2.3 Synchronous Mode of Operation

Several sensors can be used together in the synchronous operating mode in order to detect a large surface. The sensors emit ultrasonic pulses simultaneously (synchronously).

1. Connect all of the sensors' pin 2 terminals to each other.
2. Set up one sensor as the synchronous master.
3. Set up all other sensors as synchronous slaves.



INFORMATION

The O2 pin function is automatically set to synchronous output or input in synchronous master or slave mode.

Adjustment of the O2 pin function is not possible in synchronous operation sensor mode.

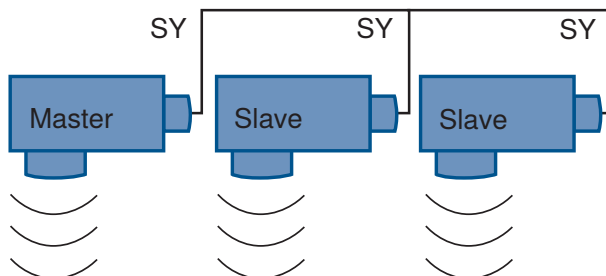

INFORMATION

Synchronous operation is only possible with the O1 output function set to PNP.

Only one digital output is available at sensors which are operated in the synchronous mode, because pin 2 is required for synchronization.



INFORMATION

Sensors in synchronous mode must have the same sonic cone settings.

The response time of the sensors is extended in synchronous mode to $1.9 \times$ response time normal mode (e.g. filter 0: response time normal mode = 17 ms; response time synchronous mode = 32 ms).

6.2.4 “Mute” Mode of Operation

When this mode of operation is activated, the sensor's ultrasonic transmitter (transducer) is switched off. No measurements are taken. The switching behavior is identical to when no signal is received in reflective operation or as a through-beam sensor.

6.2.5 Pin Functions I/O2

The function of I/O2 can be configured either as an output or an input.

External Teach-In Input

Teach in output O1 via the teach-in input.

With Ub setting active:

1. Set the function pin I/O2 as external teach-in input.
2. Apply 18...30 V to pin I/O2 for at least 1 second, but no more than 4 seconds.
3. As soon as voltage drops at the input, O1 is taught in.



INFORMATION

The setting Ub active is preset

With Ub setting inactive:

1. Set the function pin I/O2 as external teach-in input.
2. Disconnect pin I/O2 or apply 0 V to it for at least 1 second, but no more than 4 seconds.
3. As soon as voltage is applied to the input, O1 is taught in.

Locking

If the teach-in input is continuously activated, the teach-in key is locked and protected against inadvertent changes.

With Ub setting active:

1. Set the pin function of I/O2 to external teach-in input.
2. Permanently connect pin I/O2 to 18...30 V DC.
3. The sensor is protected against inadvertent changes caused by the teach-in key.



INFORMATION

The setting Ub active is preset

With Ub setting inactive:

1. Set the function pin I/O2 to external teach-in input.
2. Permanently disconnect pin I/O2 or connect it to 0 V.
3. The sensor is protected against inadvertent changes caused by the teach-in key.

Error Output

The error output is switched in the following cases:

- Very small or poorly reflective (sound-absorbing) objects are located within the working range.
- Incorrect installation.
- The object is located outside of the working range.
- Strong air turbulence.
- Excessively strong ultrasound sources are located within the measuring range.

6.2.6 External Temperature Compensation

As a standard feature, temperature is compensated with the help of the internal temperature sensor. Continuous transmission of external temperature values to the sensor is also possible.

1. Set the temperature mode to external.
2. Enter a fixed temperature or transmit the temperature value from another measuring instrument.



INFORMATION

Regular updating of external temperature data is recommended, in order to prevent abrupt temperature changes and jumps in measurement results resulting therefrom. If no temperature value is transmitted when the sensor is started up in the external temperature mode, the standard value of 23 °C is used.

6.2.7 Filter

- The selected filter affects the response time (see “Response time” on page 9) and the number of distance values that will be evaluated.
- The longer the response time of the selected filter, the more distance values are collected and evaluated.

	Filters 0 to 15	Filters 16 to 20
Mode of operation of the filters	Median filter	Median filter
Performance in case of missing/invalid distance value (e.g. deflection of the ultrasonic signal due to water movement)	Individual invalid distance values are not taken into account in the calculation of the median.	The sensor waits for a valid distance value until the specified response time has elapsed. This prevents inadvertent switching due to individual invalid values.
Performance in the event of continuous changes (continuously valid distance value)	Read-out in accordance with filter response time	Continuous changes to the fill-level are read out immediately.

7 Maintenance Instructions



NOTICE

This wenglor sensor is maintenance-free.

Cleaning and inspection of the plug connections at regular intervals are advisable.

Do not clean the sensor with solvents or cleaning agents that could damage the product.

The product must be protected against contamination during initial start-up.

8 Proper Disposal

wenglor sensoric GmbH does not accept the return of unusable or irreparable products. Respectively valid national waste disposal regulations apply to product disposal.

9 **Declarations of Conformity**

Declarations of conformity can be found on our website at www.wenglor.com in the product's separate download area.