

Z89Q003



RFID data

Storage Capacity	316 Bytes
Configuration memory	4 Bytes
Storage organization	80 × 4 Bytes
UID serial number	8 Bytes
Frequency band	13,56 MHz
Max. writing cycles	100000
RFID standard	ISO/IEC 15693

Mechanical Data

Material	Epoxy resin
Material	Plastic, PPS
Degree of Protection	IP67
Temperature Range	-20...85 °C
Storage temperature	-20...110 °C
Packaging unit	1 Piece

- Frequency band 13.56 MHz
- High degree of protection
- Passive data carrier
- Resistant to high temperature
- Rugged housing design

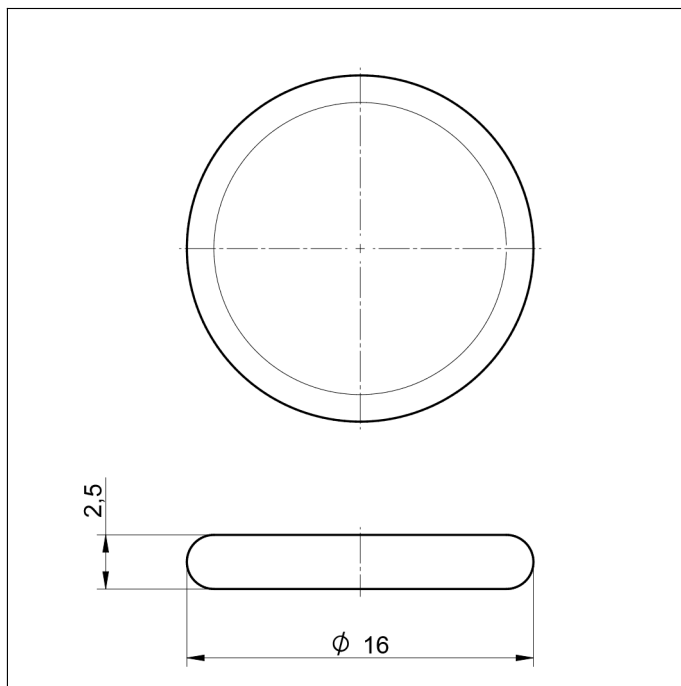

These passive RFID transponders enable contactless data processing with an RFID reader without the need for a separate power supply. The power supply is provided via the connection with an RFID reader. The RFID chip in the transponder has a globally unique identification number that can be read but not overwritten. With a frequency band of 13.56 MHz, RFID transponders offer a reliable identification solution for short-range applications.