



LMLXXX OPERATING INSTRUCTIONS

wenglorTPL

INTRODUCTION

This User Guide contains warnings and guidance for correct and safe operation of the product. These instructions must be followed at all times. wenglorTPL will not be held responsible for problems caused by using the product contrary to these instructions and the Warranty will be deemed invalid.



UNPACKING

This product is packed at the factory using suitable materials for safe transport. To open the package, do not use any cutting blade to avoid damaging the product(s). Please use the delivered accessories if needed. (Do not use any other products or equivalents to replace the delivered accessories).

In the event of damage occurring during shipping, it must be reported to the carrier at time of delivery (including noting the damage in writing on the delivery documents). It is also your responsibility to notify wenglorTPL in writing of the damage within 24 hours of receipt of the package. If these instructions are not followed, wenglorTPL reserves the right not to accept requests for return and exchange of damaged products.

RISK CLASS

The applicable Standard EN-62471 classifies LED Lighting into 4 classes according to their degree of hazard severity. The table below summarises the risks associated with our standard products.

Color	Class	Risk
White WHI, Cyan 505 nm, Red 625 nm, IR 860 nm	0	none

wenglorTPL can provide **guidance notes to minimise photo-biological risks**, including the nominal minimum operating distance. Please contact wenglorTPL through your usual representative for this information.

wenglorTPL recommends the use of **protection glasses**.



BEWARE: infrared light is **invisible** to the eye. Please refer to LED Indicators on the product to determine if it is operating.





LMLXxxx

OPERATING INSTRUCTIONS

P2/12

■ DIMENSIONS

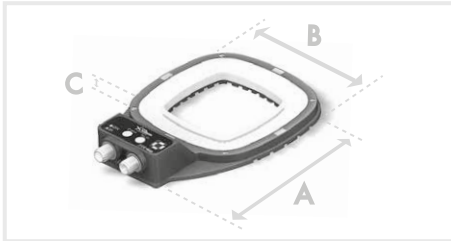

RING	Total length (mm)	Width (mm)	Height (mm)
	A	B	C
LMRX1xx	193	136	11*
LMRX2xx	257	197	11*

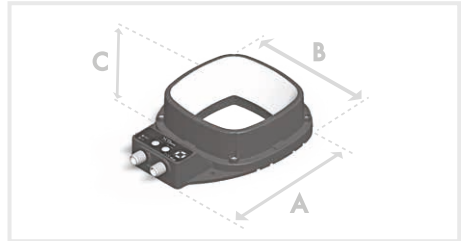

DARK FIELD	Total length (mm)	Width (mm)	Height (mm)
	A	B	C
LMFX1xx	193	136	45.5
LMFX2xx	257	197	53.5

* with connectors: 31 mm.

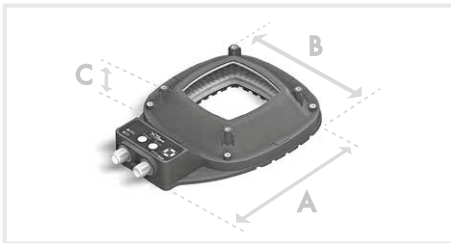

LOW ANGLE	Total length (mm)	Width (mm)	Height (mm)
	A	B	C
LMLX1xx	193	136	34.75
LMLX2xx	257	197	45.25

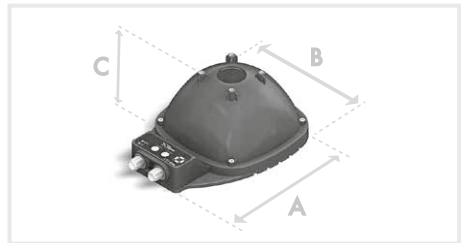

DOME	Total length (mm)	Width (mm)	Height (mm)
	A	B	C
LMDX1xx	193	136	75
LMDX2xx	257	197	106.75

■ FIXING

During the set up, the light has to be switched off and unplugged.

Please use the fixing holes designed for that purpose.

We recommend the using of M5 screws (not supplied) with a tightening torque from 0.5 to 1.5 Nm.



We also recommend the use of a threadlocker (not supplied) to avoid any risk of loosening.

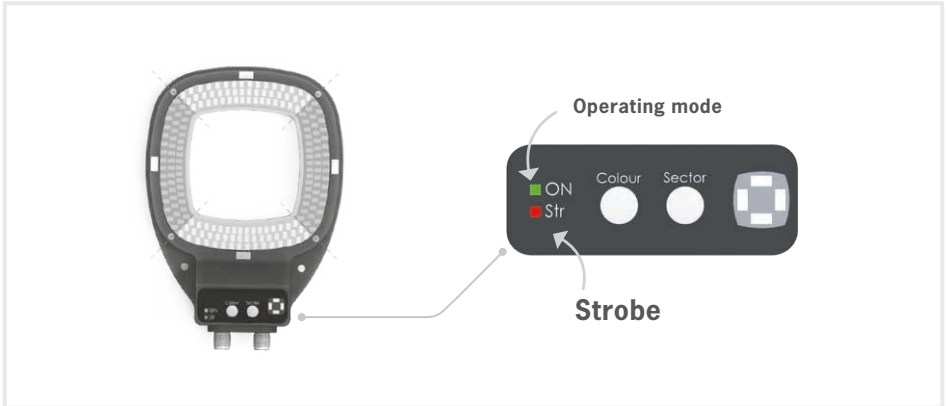

LED INDICATORS

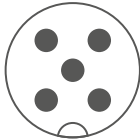
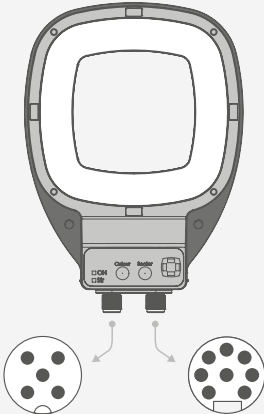

ELECTRICAL CONNECTION

M12 – 5 MALE PINS		M12 – 8 MALE PINS
 <ul style="list-style-type: none"> ■ POWER SUPPLY ■ STROBE ■ DIMMING 		 <ul style="list-style-type: none"> ■ SECTOR CONTROL ■ COLOR CONTROL ■ OVERDRIVE ENABLING ■ LOCK KEYPAD



LMLXXX

OPERATING INSTRUCTIONS

CONNECTION: M12 8 MALE PINS CONNECTOR

SECTOR CONTROL

COLOR CONTROL

OVERDRIVE ENABLING

LOCK KEYPAD

REMOTE CONTROL (CONNECTION)

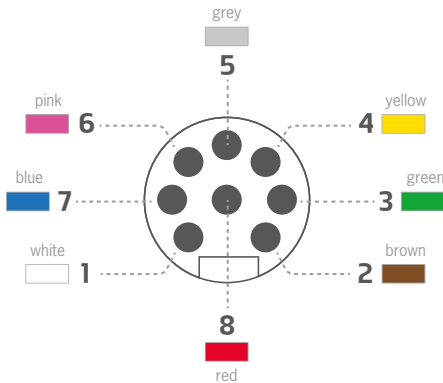

- ① **Active overdrive** → connect to 24VDC
 - ② **Change colors**
→ default color: 1 (if not connected)
→ color 2 if connected to 24 VDC
 - ③ **GND**
 - ④ Sector 1
 - ⑤ Sector 2
 - ⑥ Sector 3
 - ⑦ Sector 4
- Connect to 24VDC to turn ON
- ⑧ **Deactivate keyboard and activate the M12 8 pins connector**

REMOTE CONTROL PINOUT THROUGH PNP: 0-4V is OFF and 5-24V is ON.

SECTORS



MINIMUM WIRING



ALL SECTORS + OVERDRIVE



ALL SECTORS CW + KEYBOARD DEACTIVATED



SECTOR CONTROL VIA M12 - 8 PINS



CONNECTION: M12 5 MALE PINS CONNECTOR

POWER SUPPLY

STROBE

DIMMING

M12 Connector 5 male pins

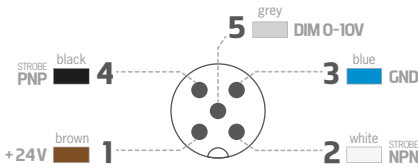

The **M12 male connector 5 points** is **COMPLIANT** with the M12 female connector 4 points. In that case, the dimming option is not available.

STROBE PNP :

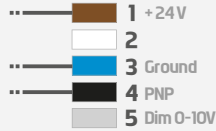

STROBE NPN :

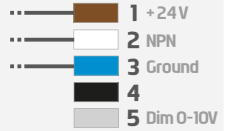

CONTINUOUS MODE :

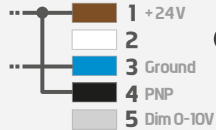

or

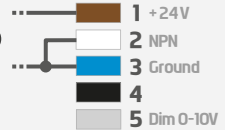

EMC IMMUNITY CONNECTIONS: for greater EMC immunity when using the light under Strobe operation, configure the signal connections as illustrated here. For Dimming, the Pin (5) should be connected to a voltage between 0V and 10V to ensure light output is correctly configured.



STROBE PNP :

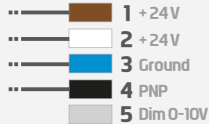

STROBE NPN :

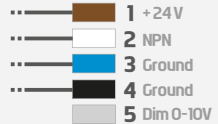

STROBE MODE

STROBE TRIGGERING MODE - PNP AND NPN

PNP : from 5 to 24V for 100% ON. From 0 to 4V for 100% OFF.

NPN : less than 2V for 100% ON. Above 2.2V for 100% OFF. Max 24V.



LMLXXX

OPERATING INSTRUCTIONS

P6/12

STROBE TIMING LIMITS

Standard version:

MINIMUM PULSE DURATION

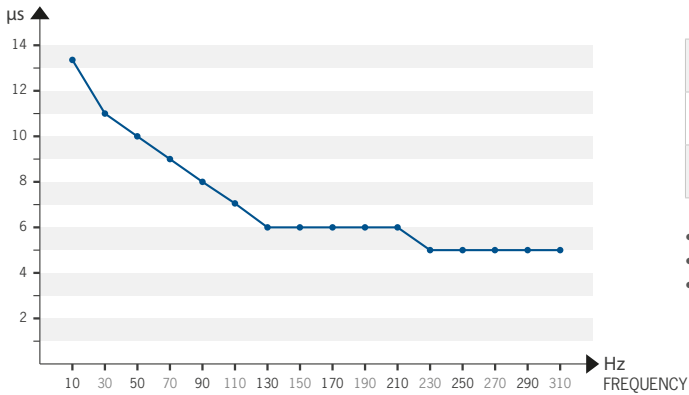

D max	100 %
t max	CW
max frequency	50 000 Hz

- D: duty cycle
- t: pulse duration
- CW: continuous working

Overdrive version:

MINIMUM PULSE DURATION

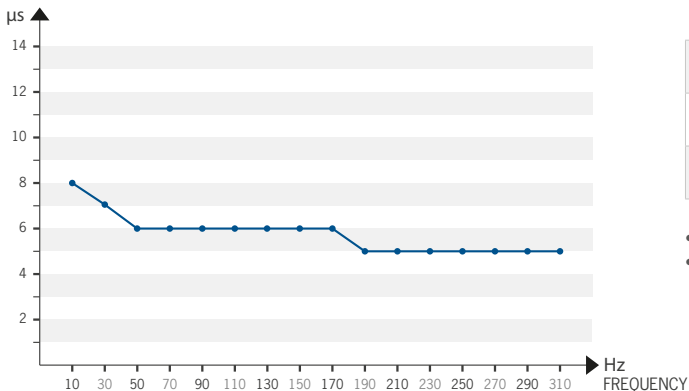

D max	10 %
t max	2 ms
max frequency	310 Hz

- D: duty cycle
- t: pulse duration



Don't exceed 310 Hz when strobing PNP/NPN in overdrive mode.



STROBING THE LIGHT VIA PNP OR NPN BEHAVIOUR

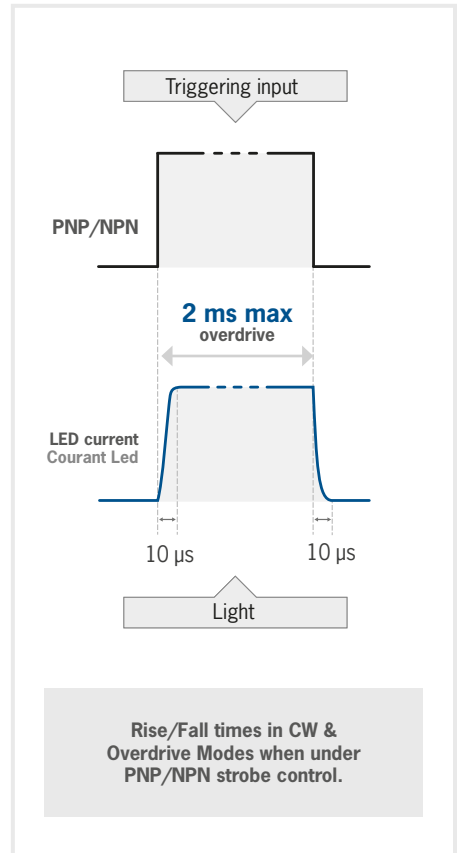
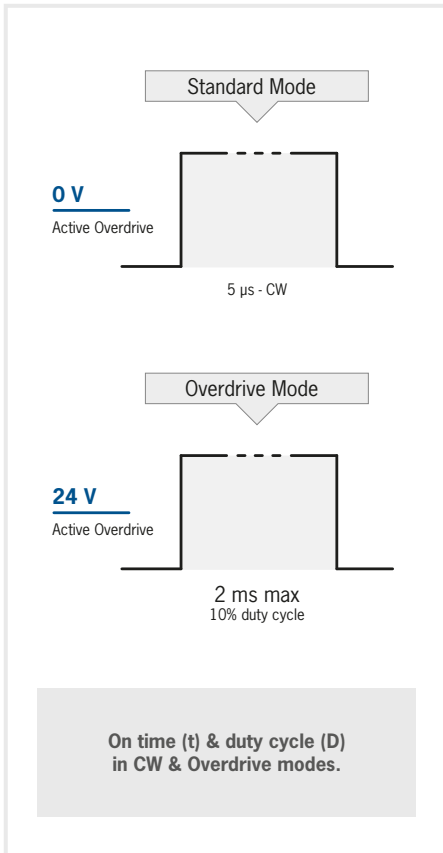

PROTECTION IN OVERDRIVE MODE

If a trigger signal of more than 2ms is applied, the LED will only remain on for a maximum of 2ms.

Duty cycle protection: you can set a 10% duty cycle max.

If this is exceeded, internal protection circuitry will activate.



■ STROBING THE LIGHT VIA COLOR & SECTOR INPUT BEHAVIOUR

To control the LED Color and illuminated Sector, the PNP or NPN trigger signal should be enabled in addition to the Sector or Color control signal(s). Timing diagrams below illustrate rise, fall and delay times.

If PNP and sectors are connected to 24V and if you strobe colors, there can be some delays between the trigger signal and the LED current.

If PNP is connected to 24V and you strobe sectors, there can be some delays between the trigger signal and the LED current. In this configuration, you have protection for maximum 2ms.

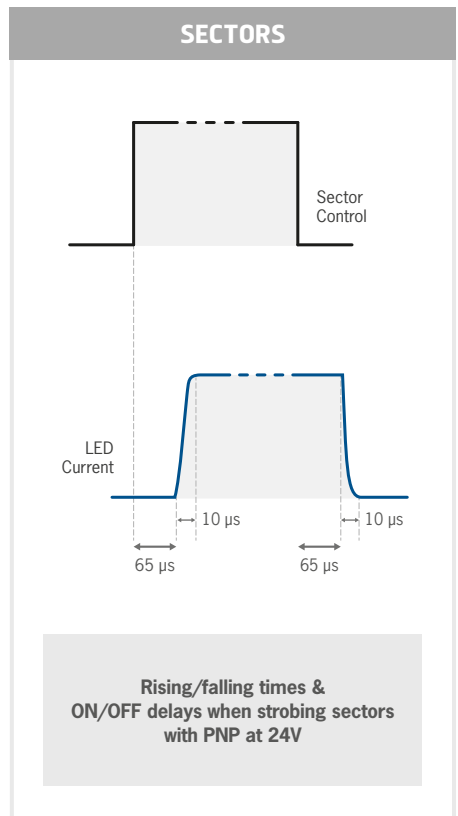
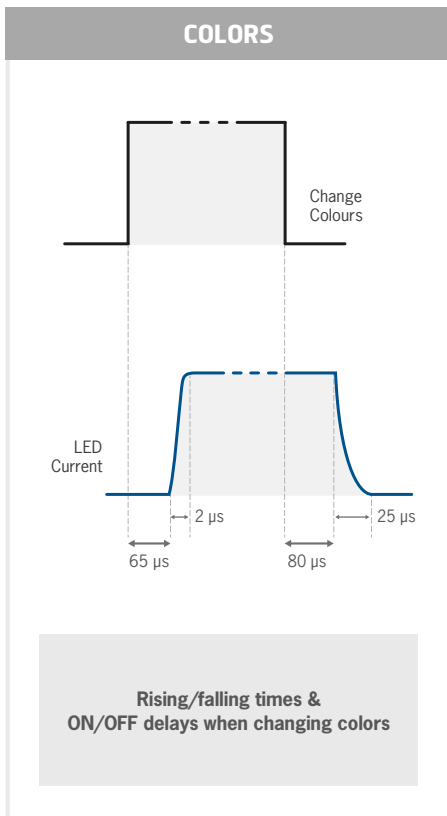



DIMMING CONTROL

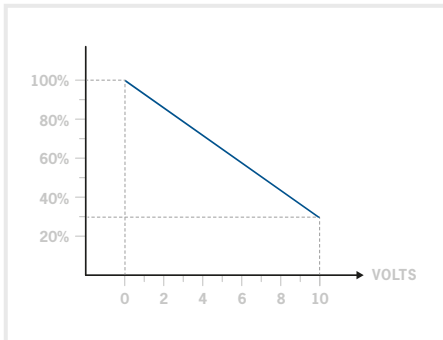

Dimming between 0 & 10 V.

With 0V applied to the Dimming pin, the product is at 100% of its lighting power. With 10V applied, it is reduced to 30% of lighting power.

POWER SUPPLY

Operational Voltage	24 V at the light input (±10%)
Absolute Maximum Voltage	30 V at the light input
Max. current consumption - strobe signal line	5 mA
Max. current consumption - remote control lines	5 mA
Max. current consumption - dimming control line	2 mA

OPERATING CONDITIONS

-10° to +40°C (14° to +104°F) / 80% of humidity without condensation. Not for outdoor use.
No thermal shock (maximum temperature variation: 10°C (18°F) in 24h).

EQUIPMENT MAINTENANCE

CLEANING (when the product is switched off)

Please use a soft and dry cloth. Do not use any abrasive material. Do not use any cleaning solvent or aggressive chemical product. wenglorTPL recommends to use isopropyl alcohol.



LMLXxxx

OPERATING INSTRUCTIONS

P10/12

KEYPAD CONTROL

The LMLXxxx works in manual control and continuous working (CW) mode by default. To use the remote control, you need to connect the 8 pin cable and apply PNP signals to the relevant pins. The LMLXxxx has Teach and Run mode.

Color and Sector Selection

- Program settings: push the 2 buttons together for 3 - 4 seconds,
- Change settings: 1 push of Color and / or Sector button(s) until desired configuration is selected,
- Save settings: push the 2 buttons together for 3 - 4 seconds.

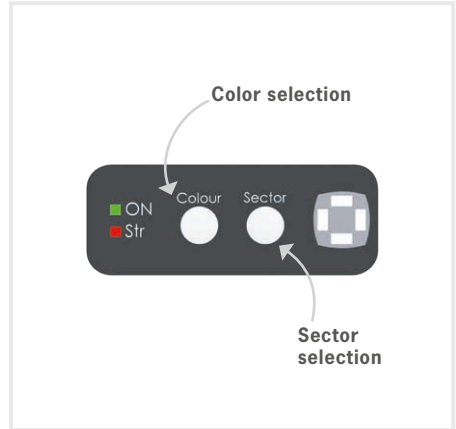

SECTOR CONFIGURATIONS

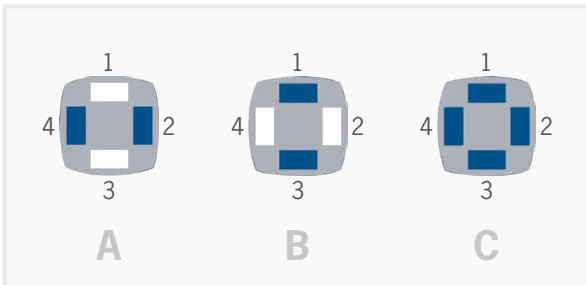

BINNING INFORMATION

wenglorTPL is extremely careful about BIN sorting in the selection of LEDs for their products.

Specifically for the Cyan series on this product, the human eye is very sensitive to color variations. It may appear to the customer that they do not appear the same between two cyan LED products. Despite any noticeable differences, the peak wavelength variation does not exceed 10nm.



■ USER SAFETY



Do not modify or dismantle all or part of the product.

Respect the power supply voltages and the connection terminals.

Ensure power supply is switched off whilst connecting product and turn on only once product is fully connected. Failure to do this may damage the product and invalidate the Warranty

Do not stare at the lighting source directly.

Follow advice below for installation to minimise operator exposure to the light source.

INSTALLATION GUIDANCE:

- Forbid or limit the direct access to the lighting source (exposure into the radiation axis).
- Establish a security perimeter to prevent the operators from approaching the lighting source beyond the recommendations of the manufacturer.
- If the workstation permits it, introduce a filter that will stop the lighting radiation under a fixed or adjustable frame between the source and the operator. When these measures cannot be implemented, supply the operators with glasses (class 4).

It is the responsibility of the persons installing this product to ensure that all means possible (such as those stated above) have been implemented to reduce exposure of the machine operators to the light emitted from this product.

■ MOUNTING ACCESSORY (OPTIONAL)

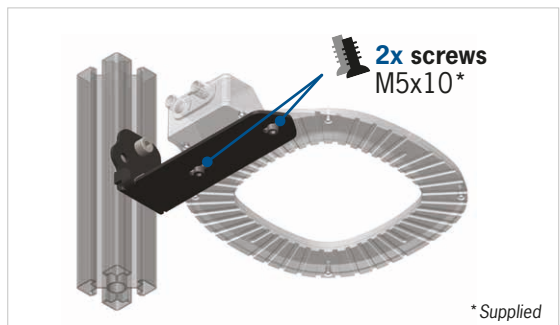



LMLXXX

OPERATING INSTRUCTIONS

■ PRODUCT LIFETIME

LED lifetime can typically be increased using strobe mode where possible. Strobing the light or turning the illumination on and off (using PNP or NPN lines) allows less temperature build up at the LED junction. The junction temperature of the LED is directly correlated with the lifetime of the LED chip. Maximum ambient air temperature = maximum 40°C/104°F.

LEDs naturally lose some intensity over time because of heat. Using the dimming and setting a reference brightness is a method for keeping the brightness level constant over a very long time, especially on brightness critical applications. wenglorTPL products have been integrated in factories since 2006, many of which are still in operation today. LED lifetime and heat management are at the forefront of our design considerations.

wenglorTPL

wenglor Straße 3
88069 Tett nang
Germany



+49 (0)7542 5399 800

support@wenglor.com

www.wenglor.com