

# EN

# P2KExxx P2KSxxx

Through-Beam Sensors



Operating Instructions

# Table of Contents

<b>1. General</b>	<b>3</b>
1.1 Information Concerning these Instructions	3
1.2 Explanations of Symbols	3
1.3 Limitation of Liability	4
1.4 Copyrights	4
<b>2. For Your Safety</b>	<b>5</b>
2.1 Use for Intended Purpose	5
2.2 Use for Other than the Intended Purpose	5
2.3 Personnel Qualifications	6
2.4 Modification of Products	6
2.5 General Safety Precautions	6
2.6 Laser/LED Warnings	6
2.7 Approvals and protection class	6
<b>3. Technical Data</b>	<b>7</b>
3.1 Technical Data	7
3.1.1 Spot Diameter	8
3.1.2 Smallest detectable part	9
3.2 Complementary Products	9
3.3 Layout	10
3.4 Control Panel	12
3.5 Scope of Delivery	12
<b>4. Transport and Storage</b>	<b>13</b>
4.1 Transport	13
4.2 Storage	13
<b>5. Installation and Electrical Connection</b>	<b>13</b>
5.1 Installation	13
5.2 Electrical Connection	14
5.3 Diagnostics	15
<b>6. Settings</b>	<b>17</b>
<b>7. IO-Link</b>	<b>17</b>
<b>8. Maintenance Instructions</b>	<b>18</b>
<b>9. Proper Disposal</b>	<b>18</b>
<b>10. Appendix</b>	<b>18</b>
10.1 List of Abbreviations	18
10.2 Change Index, Operating Instructions	18
10.3 EU Declaration of Conformity	18

# 1. General

## 1.1 Information Concerning these Instructions

- These instructions apply to the products with ID code P2KExxx and P2KSxxx.
- They make it possible to use the product safely and efficiently.
- These instructions are an integral part of the product and must be kept on hand for the entire duration of its service life.
- Local accident prevention regulations and national work safety regulations must be complied with as well.
- The product is subject to further technical development, and thus the information contained in these operating instructions may also be subject to change. The current version can be found at [www.wenglor.com](http://www.wenglor.com) in the product's separate download area.



### NOTE!

The operating instructions must be read carefully before using the product and must be kept on hand for later reference.

## 1.2 Explanations of Symbols

- Safety precautions and warnings are emphasized by means of symbols and attention-getting words
- Safe use of the product is only possible if these safety precautions and warnings are adhered to

The safety precautions and warnings are laid out in accordance with the following principle:



---

### Attention-Getting Word! Type and Source of Danger!

Possible consequences in the event that the hazard is disregarded.

- Measures for averting the hazard.

---

The meanings of the attention-getting words, as well as the scope of the associated hazards, are listed below.



---

### DANGER!

This word indicates a hazard with a high degree of risk which, if not avoided, results in death or severe injury.

---



---

### WARNING!

This word indicates a hazard with a medium degree of risk which, if not avoided, may result in death or severe injury.

---



---

### CAUTION!

This word indicates a hazard with a low degree of risk which, if not avoided, may result in minor or moderate injury.

---



---

### ATTENTION!

This word draws attention to a potentially hazardous situation which, if not avoided, may result in property damage.

---



---

### NOTE!

A note draws attention to useful tips and suggestions, as well as information regarding efficient, error-free use.

---

### **1.3 Limitation of Liability**

- The product has been developed in consideration of the current state-of-the-art and applicable standards and guidelines. Subject to change without notice.
- A valid declaration of conformity can be accessed at [www.wenglor.com](http://www.wenglor.com) in the product's separate download area.
- wenglor sensoric elektronische Geräte GmbH (hereinafter referred to as "wenglor") excludes all liability in the event of:
  - Non-compliance with the instructions
  - Use of the product for purposes other than those intended
  - Use by untrained personnel
  - Use of unapproved replacement parts
  - Unapproved modification of products
- These operating instructions do not include any guarantees from wenglor with regard to the described procedures or specific product characteristics.
- wenglor assumes no liability for printing errors or other inaccuracies contained in these operating instructions, unless wenglor was verifiably aware of such errors at the point in time at which the operating instructions were prepared.

### **1.4 Copyrights**

- The contents of these instructions are protected by copyright law.
- All rights are reserved by wenglor.
- Commercial reproduction or any other commercial use of the provided content and information, in particular graphics and images, is not permitted without previous written consent from wenglor.

## 2. For Your Safety

### 2.1 Use for Intended Purpose

The product is based on the following functional principle:

#### Through-Beam Sensors

The transmitter and receiver in through-beam sensors are integrated in separate housings. The output switches if the light beam is interrupted. The function of the transmitter and receiver can be tested with a test input. Through-beam sensors are available with laser light, red light or infrared light. The fine laser beam creates a small spot of light, which can be used to reliably detect even the smallest parts. Their good visibility facilitates easy adjustment and commissioning, even at great distances. In the case of some laser through-beam sensors, the focus is adjustable.

Aligning through-beam sensors with red light is very easy thanks to the visible light spot.

#### This product can be used in the following industry sectors:

- Special machinery manufacturing
- Heavy machinery manufacturing
- Logistics
- Automotive industry
- Food industry
- Packaging industry
- Pharmaceuticals industry
- Plastics industry
- Woodworking industry
- Consumer goods industry
- Paper industry
- Electronics industry
- Glass industry
- Steel industry
- Aviation industry
- Chemicals industry
- Alternative energy
- Raw materials extraction

### 2.2 Use for Other than the Intended Purpose

- Not a safety component in accordance with 2006/42/EC (Machinery Directive)
- The product is not suitable for use in potentially explosive atmospheres.
- The product may only be used with accessories supplied or approved by wenglor, or combined with approved products. A list of approved accessories and combination products can be accessed at [www.wenglor.com](http://www.wenglor.com) on the product detail page.

---

#### **DANGER!**



#### **Risk of personal injury or property damage in case of use for other than the intended purpose!**

- Use for other than the intended purpose may lead to hazardous situations.
- Observe instructions regarding use for intended purpose.
-

## 2.3 Personnel Qualifications

- Suitable technical training is a prerequisite.
- In-house electronics training is required.
- Trained personnel must have uninterrupted access to the operating instructions.



### **DANGER!**

**Risk of personal injury or property damage in case of incorrect initial start-up and maintenance!**

- Personal injury and damage to equipment may occur.
- Adequate training and qualification of personnel.

## 2.4 Modification of Products



### **DANGER!**

**Risk of personal injury or property damage if the product is modified!**

- Personal injury and damage to equipment may occur. Non-observance may result in loss of the CE- and/or UKCA-marking and the guarantee may be rendered null and void.
- Modification of the product is impermissible.

## 2.5 General Safety Precautions



### **NOTE!**

- These instructions are an integral part of the product and must be kept on hand for the entire duration of its service life.
- In the event of possible changes, the respectively current version of the operating instructions can be accessed at [www.wenglor.com](http://www.wenglor.com) in the product's download area.
- Read the operating instructions carefully before using the product.
- Protect the sensor against contamination and mechanical influences.

## 2.6 Laser/LED Warnings

The respective laser class or LED group is listed in the product's technical data.



### **Laser Class 1 (EN 60825-1)**

Applicable standards and safety regulations must be observed.  
 $P_p = 0.6 \text{ mW}$ ,  $t = 3.4 \mu\text{s}$ ,  $\lambda = 680 \text{ nm}$

## 2.7 Approvals and protection class

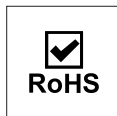
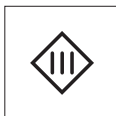

## 3. Technical Data

### 3.1 Technical Data

<b>Optical Data</b>	
Service life (ambient temp. = +25° C)	100000 h
Max. permissible ambient light	10000 Lux
<b>Electrical Data</b>	
Supply power	10...30 V DC
IO-Link supply voltage	18...30 V DC
	-40...60 °C
Switching output voltage drop	< 2 V
Switching output switching current	100 mA
Switching output residual current	< 50 $\mu$ A
Short-circuit protection	Yes
Reverse polarity protected	Yes
Overload-proof	Yes
Lockable	Yes
Interface	IO-Link
IO-Link version	1.1
Protection class	III
<b>Mechanical Data</b>	
Setting method	Potentiometer
Housing material	Stainless Steel V4A
Degree of protection	IP68/IP69K
Connection	M8×1
Lens cover	PMMA
ECOLAB	yes

Order Number Technical Data	P2KS		P2KE			
	002	003**	004	009	007**	010**
Sensor Type	Emitter		Receiver			
Range	6,000 mm	10,000 mm	6,000 mm		10,000 mm	
Light Source	Red Light	Laser (red)	Red Light		Laser (red)	
Laser Class (EN 60825-1)	—	1	—		1	
Switching hysteresis	—	—	< 10 %		< 15 %	
Spot Diameter	see Table 1	see Tab. 2	—		—	
Smallest detectable part	—	—	see Table 3		see Table 4	
Current consumption (operating voltage = 24 V)	< 20 mA	<15 mA	< 20 mA		<15 mA	
Switching Frequency	—	—	1,000 Hz		4,500 Hz	
Response Time	—	—	0.5 ms		0.11 ms	
Switching frequency (Interference-free-Mode)	—	—	500 Hz		2,000 Hz	
Response time (Interference-free-Mode)	—	—	1 ms		0.25 ms	
Temperature range	-40...60 °C	-40...50 °C	-40...60 °C		-40...50 °C	
Temperature drift	< 10 %	< 10 % *	< 10 %		< 10 % *	
Output function	PNP	—	x		x	
	NPN	—		x		x
	NO					
	NC			x	x	x
Connection Diagram No.	703	703	217	218	217	218
Suitable Mounting Technology No.	8	8	8	8	8	8

\* For the sensors with Light Source Laser (red) the Temperature drift is depending on the ambient temperature

Temperature drift (-10 °C < Tu < 40 °C): < 10 %

Temperature drift (-30 °C < Tu < -10 °C, 40 °C < Tu < 50 °C): < 20 %

Temperature drift (-40 °C < Tu < -30 °C): < 30 %

\*\* The values specified in the data sheet apply after a 10-minute warm-up time of the devices.

### 3.1.1 Spot Diameter

Range	1 m	2 m	6 m
Spot diameter	70 mm	140 mm	500 mm

Table 1

Range	1 m	6 m	10 m
Spot diameter	2.5 mm	25 mm	40 mm

Table 2

### 3.1.2 Smallest detectable part

Range	1 m	2 m	6 m
Smallest detectable part	4 mm	1 mm	1 mm

Table 3

Range	1 m	6 m	10 m
Smallest detectable part	2.5 mm	1.0 mm	1.5 mm

Table 4

## 3.2 Complementary Products

wenglor can provide you with suitable connection technology for your product.

Suitable mounting technology no. **400**

Suitable connection technology no. **8**

**S04**

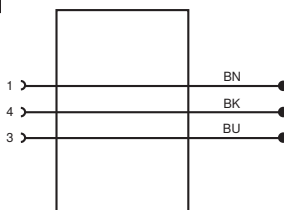

IO-Link master EFBL001, EFBL003, EP0L001

wTeach2 software DNNF005

Software IO-Link Device Tool DNNF019

Hygienically designed screws BEF-SET-48

### 3.3 Layout

P2KE004, P2KE007, P2KE009, P2KE010

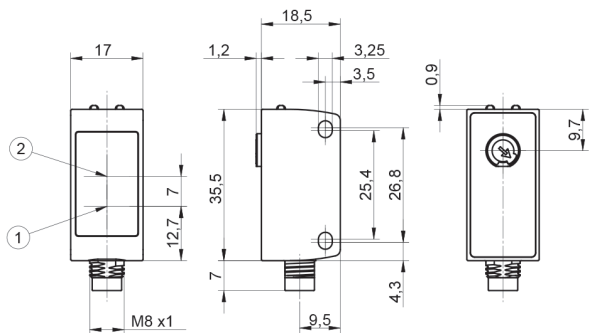

P2KS002, P2KS003

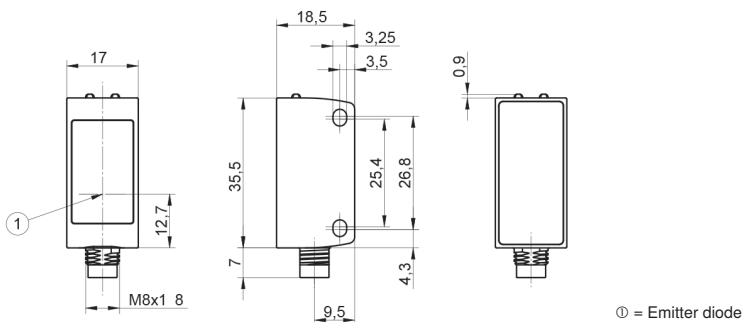

Screw M3 = 0.5 Nm

Plug M8×1 without snap-fit connection

Potentiometer = 40 Nmm

Dimensions specified in mm (1 mm = 0.03937 Inch)

### 3.4 Control Panel

Receiver

**1K1**

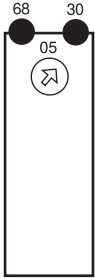

Emitter

**1K2**

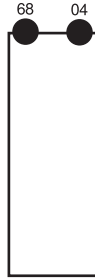

04 = Function indicator  
05 = switching distance adjuster  
30 = switching status indicator / contamination warning  
68 = supply power indicator

### 3.5 Scope of Delivery

- Sensor (emitter or receiver)
- Safety precautions

## 4. Transport and Storage

### 4.1 Transport

Upon receipt of shipment, the goods must be inspected for damage in transit. In the case of damage, conditionally accept the package and notify the manufacturer of the damage. Then return the device, making reference to damage in transit.

### 4.2 Storage

**The following points must be taken into condition with regard to storage:**

- Do not store the product outdoors.
- Store the product in a dry, dust-free place.
- Protect the product against mechanical impacts.
- Protect the product against exposure to direct sunlight.



#### **ATTENTION!**

#### **Risk of property damage in case of improper storage!**

The product may be damaged.

- Storage instructions must be complied with.
- 

## 5. Installation and Electrical Connection

### 5.1 Installation

- Protect the product from contamination during installation.
- Observe all applicable electrical and mechanical regulations, standards, and safety rules.
- Protect the product against mechanical influences.
- Make sure that the sensor is mounted in a mechanically secure fashion.
- Specified torque values must be complied with ([see section “3. Technical Data”, page 7](#)).



#### **ATTENTION!**

#### **Risk of property damage in case of improper installation!**

The product may be damaged.

- Installation instructions must be complied with.
- 



#### **CAUTION!**

#### **Risk of personal injury or property damage during installation!**

Personal injury and damage to the product may occur.

- A safe installation environment must be assured.
-

## 5.2 Electrical Connection

217

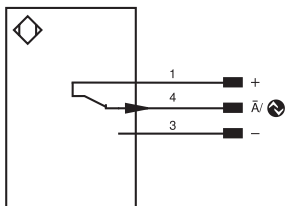

218

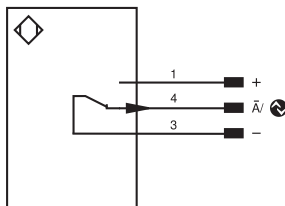

703

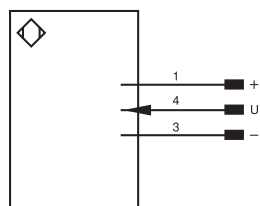

### Legend

+	Supply Voltage +
-	Supply Voltage 0 V
~	Supply Voltage (AC Voltage)
A	Switching Output (NO)
$\bar{A}$	Switching Output (NC)
V	Contamination/Error Output (NO)
$\bar{V}$	Contamination/Error Output (NC)
E	Input (analog or digital)
T	Teach Input
Z	Time Delay (activation)
S	Shielding
RxD	Interface Receive Path
TxD	Interface Send Path
RDY	Ready
GND	Ground
CL	Clock
E/A	Output/Input programmable
	IO-Link
PoE	Power over Ethernet
IN	Safety Input
QSSD	Safety Output
Signal	Signal Output
Bl_D +/-	Ethernet Gigabit bidirect. data line (A-D)
ENoRS422	Encoder 0-pulse 0-0̄ (TTL)

PT	Platinum measuring resistor
nc	not connected
U	Test Input
$\bar{U}$	Test Input inverted
W	Trigger Input
W-	Ground for the Trigger Input
O	Analog Output
O-	Ground for the Analog Output
BZ	Block Discharge
AVV	Valve Output
a	Valve Control Output +
b	Valve Control Output 0 V
SY	Synchronization
SY-	Ground for the Synchronization
E+	Receiver-Line
S+	Emitter-Line
$\mp$	Grounding
SnR	Switching Distance Reduction
Rx +/-	Ethernet Receive Path
Tx +/-	Ethernet Send Path
Bus	Interfaces-Bus A(+)/B(-)
La	Emitted Light disengageable
Mag	Magnet activation
RES	Input confirmation
EDM	Contacting Monitoring

ENaRS422	Encoder A/ $\bar{A}$ (TTL)
ENbRS422	Encoder B/ $\bar{B}$ (TTL)
ENA	Encoder A
ENb	Encoder B
AMIN	Digital output MIN
AMAX	Digital output MAX
AOK	Digital output OK
SY In	Synchronization In
SY OUT	Synchronization OUT
OLT	Brightness output
M	Maintenance
rSV	reserved
Wire Colors according to IEC 60757	
BK	Black
BN	Brown
RD	Red
OG	Orange
YE	Yellow
GN	Green
BU	Blue
VT	Violet
GY	Grey
WH	White
PK	Pink
GNYE	Green/Yellow

### DANGER!



#### Risk of personal injury or property damage due to electric current!

Voltage conducting parts may cause personal injury or damage to equipment.

- The electric device may only be connected by appropriately qualified personnel.

## 5.3 Diagnostics

Causes for Triggering the Contamination Warning (blinking LED):

Display LED	Diagnosis/Cause	Elimination
Continuous blinking at approx. 2.5 Hz	Contamination	Carefully clean the optic cover with a cloth.
	Aged emitter diode	Replace the sensor.
	Unreliable working range	<ul style="list-style-type: none"> <li>• Increase the sensor's switching distance.</li> <li>• Reduce distance between sensor and receiver.</li> </ul>
Continuous blinking at approx. 5 Hz	Short-circuit	Check electrical wiring and eliminate the short-circuit.
	Over-temperature	Disconnect the sensor from supply power and allow it to cool down.
	Hardware error	Replace the sensor.

### Contamination Warning Flowcharts

#### Through Beam Sensor

##### no contamination

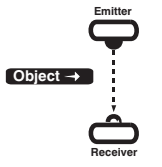
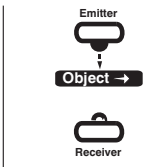
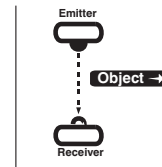
			
Object	not detected	detected	not detected
Switching Status Indicator	on ●	off ○	on ●

##### beginning contamination

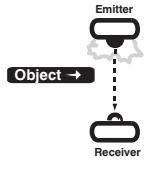
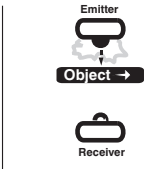
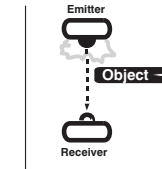
			
Object	not detected	detected	not detected
Switching Status Indicator	on ●	off ○	blinking ●

##### advanced contamination

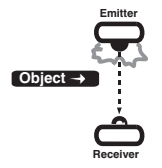
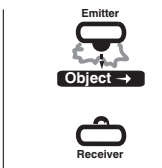
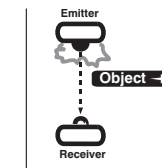
			
Object	not detected	not detected	not detected
Switching Status Indicator	off ○	off ○	off ○

## Required action in case of fault:



### NOTE!

- Shut down the machine.
- Analyze and eliminate the cause of error with the help of the diagnostics information.
- If the error cannot be eliminated, please contact wenglor's support department.
- Do not operate in case of indeterminate malfunctioning.
- The machine must be shut down if the error cannot be unequivocally clarified or reliably eliminated.

---

### DANGER!



#### **Risk of personal injury or property damage in case of non-compliance!**

- The system's safety function is disabled. Personal injury and damage to equipment.
- Required action as specified in case of fault.
- 

## 6. Settings

- Emitter and receiver must be securely mounted.
- Turn the receivers potentiometer all the way up (right stop).
- Observe the warm-up time for the laser light barrier.
- Turn back the potentiometer to its left stop. Turn the potentiometer up, until the output is activated.
- Keep on turning the potentiometer about 5° in order to increase the switching reserve.
- Place the object to be scanned within the light barrier and check for correct functioning.

### Test Input

If the test input is open or connected with minus, the barrier works normally.

If it is connected with plus, the sensor switches off. The barrier is tested via this changing of the switching status.

## 7. IO-Link

Further settings are possible via the IO-Link interface. The IO-Link can be found at [www.wenglor.com](http://www.wenglor.com) in the product's download area.

## 8. Maintenance Instructions



### NOTE!

- This wenglor sensor is maintenance-free.
- Cleaning and inspection of the plug connections at regular intervals are advisable.
- Do not clean the sensor with solvents or cleansers which could damage the product.
- The product must be protected against contamination during initial start-up.

## 9. Proper Disposal

wenglor sensoric GmbH does not accept the return of unusable or irreparable products. Respectively valid national waste disposal regulations apply to product disposal.

## 10. Appendix

### 10.1 List of Abbreviations

Abbreviation	Meaning
Tu	Ambient temperature
Ub	Supply voltage
IODD	IO Device Description
MTTFd	Mean Time to Dangerous Failure

### 10.2 Change Index, Operating Instructions

Version	Date	Description/Change
1.0.0	19.07.21	Initial version of the operating instructions
1.2.0	19.06.23	Addition in chapter 2.7, chapter 3 and chapter 6

### 10.3 Declarations of Conformity

The declarations of conformity can be found on our website at [www.wenglor.com](http://www.wenglor.com) in the product's download area.

