

P2KKxxx

Retro-Reflex Sensors for Transparent Objects



Operating Instructions

Table of Contents

1. General	3
1.1 Information Concerning these Instructions	3
1.2 Explanations of Symbols	3
1.3 Limitation of Liability	4
1.4 Copyrights	4
2. For Your Safety	5
2.1 Use for Intended Purpose	5
2.2 Use for Other than the Intended Purpose	5
2.3 Personnel Qualifications	6
2.4 Modification of Products	6
2.5 General Safety Precautions	6
2.6 Approvals and protection class	6
3. Technical Data	7
3.1 Technical Data	7
3.1.1 Spot diameter	8
3.1.2 Smallest detectable part	8
3.1.3 Switching distance	8
3.2 Complementary Products	9
3.3 Layout	9
3.4 Control Panel	10
3.5 Scope of Delivery	10
4. Transport and Storage	10
4.1 Transport	10
4.2 Storage	10
5. Installation and Electrical Connection	11
5.1 Installation	11
5.2 Electrical Connection	11
5.3 Diagnostics	12
6. Settings	14
7. I/O-Link	14
8. Maintenance Instructions	14
9. Proper Disposal	14
10. Appendix	15
10.1 List of Abbreviations	15
10.2 Change Index, Operating Instructions	15
10.3 EU Declaration of Conformity	15

1. General

1.1 Information Concerning these Instructions

- These instructions apply to the product with ID code P2KKxxx.
- They make it possible to use the product safely and efficiently.
- These instructions are an integral part of the product and must be kept on hand for the entire duration of its service life.
- Local accident prevention regulations and national work safety regulations must be complied with as well.
- The product is subject to further technical development, and thus the information contained in these operating instructions may also be subject to change. The current version can be found at www.wenglor.com in the product's separate download area.



NOTE!

The operating instructions must be read carefully before using the product and must be kept on hand for later reference.

1.2 Explanations of Symbols

- Safety precautions and warnings are emphasized by means of symbols and attention-getting words
- Safe use of the product is only possible if these safety precautions and warnings are adhered to

The safety precautions and warnings are laid out in accordance with the following principle:



Attention-Getting Word! Type and Source of Danger!

Possible consequences in the event that the hazard is disregarded.

- Measures for averting the hazard.

The meanings of the attention-getting words, as well as the scope of the associated hazards, are listed below.



DANGER!

This word indicates a hazard with a high degree of risk which, if not avoided, results in death or severe injury.



WARNING!

This word indicates a hazard with a medium degree of risk which, if not avoided, may result in death or severe injury.



CAUTION!

This word indicates a hazard with a low degree of risk which, if not avoided, may result in minor or moderate injury.



ATTENTION!

This word draws attention to a potentially hazardous situation which, if not avoided, may result in property damage.



NOTE!

A note draws attention to useful tips and suggestions, as well as information regarding efficient, error-free use.

1.3 Limitation of Liability

- The product has been developed in consideration of the current state-of-the-art and applicable standards and guidelines. Subject to change without notice.
- A valid declaration of conformity can be accessed at www.wenglor.com in the product's separate download area.
- wenglor sensoric elektronische Geräte GmbH (hereinafter referred to as "wenglor") excludes all liability in the event of:
 - Non-compliance with the instructions
 - Use of the product for purposes other than those intended
 - Use by untrained personnel
 - Use of unapproved replacement parts
 - Unapproved modification of products
- These operating instructions do not include any guarantees from wenglor with regard to the described procedures or specific product characteristics.
- wenglor assumes no liability for printing errors or other inaccuracies contained in these operating instructions, unless wenglor was verifiably aware of such errors at the point in time at which the operating instructions were prepared.

1.4 Copyrights

- The contents of these instructions are protected by copyright law.
- All rights are reserved by wenglor.
- Commercial reproduction or any other commercial use of the provided content and information, in particular graphics and images, is not permitted without previous written consent from wenglor.

2. For Your Safety

2.1 Use for Intended Purpose

The product is based on the following functional principle:

Retro-Reflex Sensors for Clear Glass Recognition

Reflex sensors for clear glass recognition can be adjusted so precisely that they can reliably recognize highly transparent objects such as glass, glass bottles or sheet products. Even shiny, chromed or reflective surfaces can be reliably detected thanks to the integrated polarization filter.

The transmitter and receiver are located in a single housing and require a reflector to work. The output switches if the light beam between the sensor and reflector is interrupted. The visible light spot of retro-reflex sensors facilitates adjustment and commissioning. Depending on the sensor type, even small objects up to 0.1mm can be reliably detected over long distances.

This product can be used in the following industry sectors:

- Special machinery manufacturing
- Heavy machinery manufacturing
- Logistics
- Automotive industry
- Food industry
- Packaging industry
- Pharmaceuticals industry
- Plastics industry
- Woodworking industry
- Beverages industry
- Consumer goods industry
- Paper industry
- Electronics industry
- Glass industry
- Steel industry
- Aviation industry
- Chemicals industry
- Alternative energy
- Raw materials extraction

2.2 Use for Other than the Intended Purpose

- Not a safety component in accordance with 2006/42/EC (Machinery Directive)
- The product is not suitable for use in potentially explosive atmospheres.
- The product may only be used with accessories supplied or approved by wenglor, or combined with approved products. A list of approved accessories and combination products can be accessed at www.wenglor.com on the product detail page.

DANGER!



Risk of personal injury or property damage in case of use for other than the intended purpose!

- Use for other than the intended purpose may lead to hazardous situations.
- Observe instructions regarding use for intended purpose.
-

2.3 Personnel Qualifications

- Suitable technical training is a prerequisite.
- In-house electronics training is required.
- Trained personnel must have uninterrupted access to the operating instructions.



DANGER!

Risk of personal injury or property damage in case of incorrect initial start-up and maintenance!

- Personal injury and damage to equipment may occur.
- Adequate training and qualification of personnel.
-

2.4 Modification of Products



DANGER!

Risk of personal injury or property damage if the product is modified!

- Personal injury and damage to equipment may occur. Non-observance may result in loss of the CE marking and the guarantee may be rendered null and void.
- Modification of the product is impermissible.
-

2.5 General Safety Precautions



NOTE!

- These instructions are an integral part of the product and must be kept on hand for the entire duration of its service life.
- In the event of possible changes, the respectively current version of the operating instructions can be accessed at www.wenglor.com in the product's download area.
- Read the operating instructions carefully before using the product.
- Protect the sensor against contamination and mechanical influences.

2.6 Approvals and protection class



3. Technical Data

3.1 Technical Data

Technical Data		Order Number	P1KK	
			001	003
Optical Data				
Range			1,500 mm	
Reference reflector			RQ100BA	
Clear glass recognition			yes	
Switching hysteresis			< 5 %	
Light source			Red light	
Polarization filter			yes	
Service life (ambient temp. = +25° C)			100,000 h	
Max. permissible ambient light			10,000 Lux	
Aperture angle			3°	
Single-lens optics			yes	
Spot diameter			See table 1	
Electrical Data				
Supply power			10...30 V DC	
IO-Link supply voltage			18...30 V DC	
Current consumption (operating voltage = 24 V)			< 20 mA	
Switching frequency			2000 Hz	
Switching frequency (speed mode)			3500 Hz	
Response time			0,25 ms	
Response time (speed mode)			0,14 ms	
Temperature drift			< 5 %	
Temperature range			-40...60 °C	
Switching output voltage drop			< 2 V	
Switching output switching current			100 mA	
Switching output residual current			< 50 µA	
Short-circuit protection			yes	
Reverse polarity protected			yes	
Overload-proof			yes	
Lockable			yes	
Interface			IO-Link	
IO-Link version			1.1	
Protection class			III	
Output function	PNP		×	
	NPN			×
	NC, NO antivalent		×	×
Connection Diagram No.			215	213
Mechanical Data				
Setting method			Potentiometer	
Housing material			Stainless steel V4A	
Degree of protection			IP68/IP69K	
Connection			M8 × 1; 4-pin	
Lens cover			PMMA	
ECOLAB			yes	
Technical Safety Data				
MTTFd (EN ISO 13849-1)			2375,05 a	

3.1.1 Spot diameter

Working Distance	0,2 m	1 m	1,5 m
Spot diameter	20 mm	90 mm	130 mm

Table 1

3.1.2 Smallest detectable part

Distance, Sensor to Reflector	0,2 m	1 m	1,5 m
Smallest detectable part	0,7 mm	6 mm	10 mm

Table 2

3.1.3 Switching distance

Achievable switching distance depends on the utilized reflector. Nominal switching distance is achieved with reflector types RQ100BA. Achievable ranges for other reflectors are listed in the following tables:

Reflector	Range
RQ100BA	0...1,50 m
RE18040BA	0...1,50 m
RQ84BA	0...1,50 m
RR84BA	0...1,50 m
RE9538BA	0...0,70 m
RE6151BM	0...1,30 m
RR50_A	0...1,50 m
RE6040BA	0...1,40 m
RE8222BA	0...1,00 m
RR34_M	0...1,00 m
RE3220BM	0...0,60 m
RE6210BM	0...0,60 m
RR25_M	0...0,70 m
RR25KP	0...0,25 m
RR21_M	0...0,60 m
ZRAE02B01	0...0,60 m
ZRME01B01	0...0,25 m
ZRME03B01	0...0,65 m
ZRMR02K01	0...0,40 m
ZRMS02_01	0...0,55 m
RF505	0...0,50 m
RF508	0...0,50 m
RF258	0...0,45 m
ZRDF03K01	0...1,10 m
ZRDF10K01	0...1,20 m



NOTE!

In order to increase the stability in the detection of highly transparent objects, it is recommended to use reflectors with microstructure.

3.2 Complementary Products

wenglor can provide you with suitable connection technology for your product.

Suitable mounting technology no.	400
Suitable connection technology no.	7
	S02

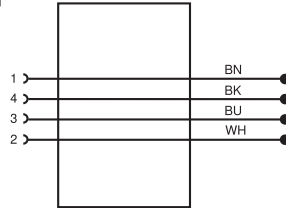

IO-Link master EFBL001, EFBL003, EP0L001

wTeach2 software DNNF005

Software IO-Link Device Tool DNNF019

Hygienically designed screws BEF-SET-48

3.3 Layout

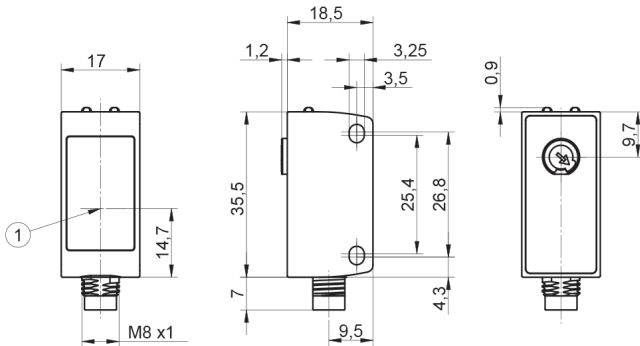

1 = Optical axis
M3 screw = 0,5 Nm
Plug M8×1 without snap-fit connection
Potentiometer = 40 Nmm

Dimensions specified in mm (1 mm = 0.03937")

3.4 Control Panel

1K1

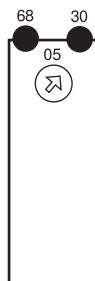

05 = switching distance adjuster
30 = switching status indicator / contamination warning
68 = supply power indicator

3.5 Scope of Delivery

- Sensor
- Safety precautions

4. Transport and Storage

4.1 Transport

Upon receipt of shipment, the goods must be inspected for damage in transit. In the case of damage, conditionally accept the package and notify the manufacturer of the damage. Then return the device, making reference to damage in transit.

4.2 Storage

The following points must be taken into condition with regard to storage:

- Do not store the product outdoors.
- Store the product in a dry, dust-free place.
- Protect the product against mechanical impacts.
- Protect the product against exposure to direct sunlight.



ATTENTION!

Risk of property damage in case of improper storage!

The product may be damaged.

- Storage instructions must be complied with.
-

5. Installation and Electrical Connection

5.1 Installation

- Protect the product from contamination during installation.
- Observe all applicable electrical and mechanical regulations, standards, and safety rules.
- Protect the product against mechanical influences.
- Make sure that the sensor is mounted in a mechanically secure fashion.
- Specified torque values must be complied with (see section “3. Technical Data”, page 7).

ATTENTION!



Risk of property damage in case of improper installation!

The product may be damaged.

- Installation instructions must be complied with.

CAUTION!



Risk of personal injury or property damage during installation!

Personal injury and damage to the product may occur.

- A safe installation environment must be assured.

5.2 Electrical Connection

[213]

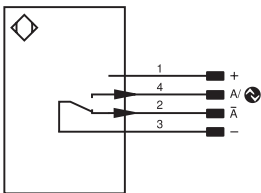

[215]

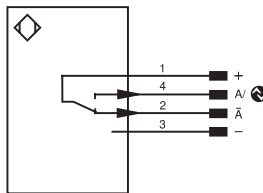

Legend

+	Supply Voltage +
-	Supply Voltage 0 V
~	Supply Voltage (AC Voltage)
A	Switching Output (NO)
Ä	Switching Output (NC)
V	Contamination/Error Output (NO)
Û	Contamination/Error Output (NC)
E	Input (analog or digital)
T	Teach Input
Z	Time Delay (activation)
S	Shielding
RxD	Interface Receive Path
TxD	Interface Send Path
RDY	Ready
GND	Ground
CL	Clock
E/A	Output/Input programmable
	IO-Link
PaE	Power over Ethernet
IN	Safety Input
OSD	Safety Output
Signal	Signal Output
Bl_D-/-	Ethernet Gigabit bidirect. data line (A-D)
EN0542	Encoder 0-pulse 0-0 (TTL)

PT	Platinum measuring resistor
nc	not connected
U	Test Input
Ü	Test Input inverted
W	Trigger Input
W-	Ground for the Trigger Input
O	Analog Output
O-	Ground for the Analog Output
BZ	Block Discharge
AWV	Valve Output
a	Valve Control Output +
b	Valve Control Output 0 V
SY	Synchronization
SY-	Ground for the Synchronization
E+	Receiver-Line
S+	Emitter-Line
±	Grounding
SnR	Switching Distance Reduction
Rx+/-	Ethernet Receive Path
Tx+/-	Ethernet Send Path
BuB	Interfaces-Bus A(+)/B(-)
La	Emitted Light disengageable
Mag	Magnet activation
RES	Input confirmation
EDM	Contactor Monitoring

EN4542 Encoder A/Ä (TTL)

EN1542 Encoder B/B (TTL)

ENA Encoder A

ENb Encoder B

AMIN Digital output MIN

AMAX Digital output MAX

AOK Digital output OK

SY In Synchronization In

SY OUT Synchronization OUT

OL Brightness output

M Maintenance

fsv reserved

Wire Colors according to IEC 60757

BK Black

BN Brown

RD Red

OG Orange

YE Yellow

GN Green

BU Blue

VT Violet

GY Grey

WH White

PK Pink

GNYE Green/Yellow

DANGER!**Risk of personal injury or property damage due to electric current!**

Voltage conducting parts may cause personal injury or damage to equipment.

- The electric device may only be connected by appropriately qualified personnel.
-

5.3 Diagnostics

Causes for Triggering the Contamination Warning (blinking LED):

Display LED	Diagnosis/Cause	Elimination
Continuous blinking at approx. 2.5 Hz	Contamination	Carefully clean the optic cover with a cloth.
	Aged emitter diode	Replace the sensor.
	Unreliable working range	<ul style="list-style-type: none">• Increase the sensor's switching distance.• Reduce distance between sensor and reflector.
Continuous blinking at approx. 5 Hz	Short-circuit	Check electrical wiring and eliminate the short-circuit.
	Over-temperature	Disconnect the sensor from supply power and allow it to cool down.
	Hardware error	Replace the sensor.

Contamination Warning Flowcharts

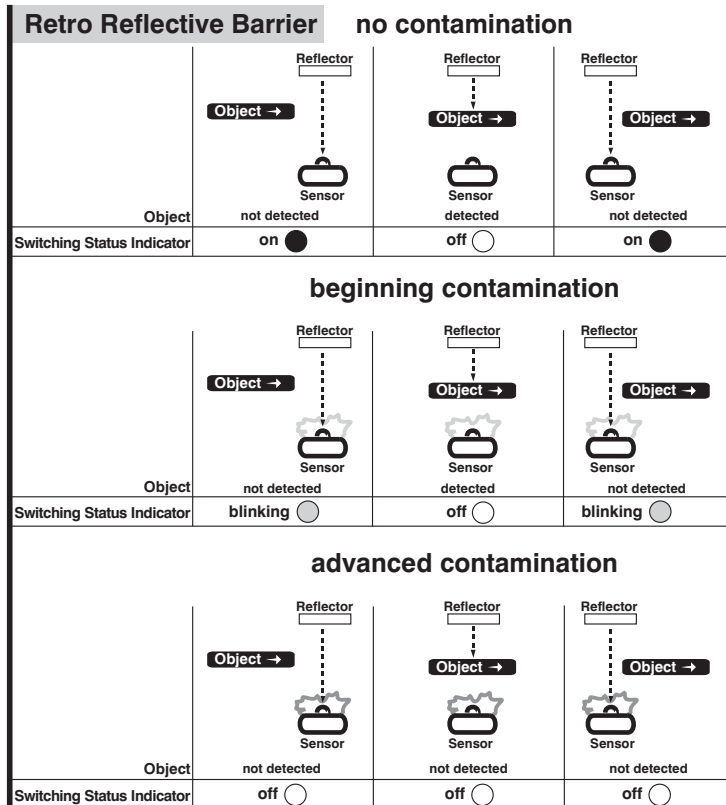

Required action in case of fault:

NOTE!

- Shut down the machine.
- Analyze and eliminate the cause of error with the help of the diagnostics information.
- If the error cannot be eliminated, please contact wenglor's support department.
- Do not operate in case of indeterminate malfunctioning.
- The machine must be shut down if the error cannot be unequivocally clarified or reliably eliminated.



DANGER!

Risk of personal injury or property damage in case of non-compliance!

- The system's safety function is disabled. Personal injury and damage to equipment.
- Required action as specified in case of fault.



6. Settings

- Align the sensor to the reflector.
- Make sure that the sensor and the reflector are mounted in a mechanically secure fashion.
- Turn the potentiometer all the way to the left.
- Turn the potentiometer clockwise until the output is switched.
- Continue to turn up the potentiometer until the LED no longer blinks.
- Move the object into the light barrier and check for correct functioning.

7. I/O-Link

Further settings are possible via the IO-Link interface. The IO-Link can be found at www.wenglor.com in the product's download area.

8. Maintenance Instructions

NOTE!



- This wenglor sensor is maintenance-free.
- Cleaning and inspection of the plug connections at regular intervals are advisable.
- Do not clean the sensor with solvents or cleansers which could damage the product.
- The product must be protected against contamination during initial start-up.

9. Proper Disposal

wenglor sensoric GmbH does not accept the return of unusable or irreparable products. Respectively valid national waste disposal regulations apply to product disposal.

10. Appendix

10.1 List of Abbreviations

Abbreviation	Meaning
Tu	Ambient temperature
Ub	Supply voltage
IODD	IO Device Description
MTTFd	Mean Time to Dangerous Failure

10.2 Change Index, Operating Instructions

Version	Date	Description/Change
1.0.0	04.08.21	Initial version of the operating instructions
1.0.1	09.05.22	Actualization see section “3. Technical Data” on page 7, “3.1.3 Switching distance” on page 8 and “3.3 Layout” on page 9

10.3 EU Declaration of Conformity

The EU declaration of conformity can be found on our website at www.wenglor.com in the product's download area.