

Safety Light Curtain

Finger Protection

SEMG542



- Easy configuration via wiring
- Protection field over the entire length of the housing for an installation without protrusion
- Quick alignment through visible red light
- Slim design for easy integration

These safety light curtains complete all basic tasks with ease. The basic functions of safety operating mode, restart inhibit and contactor monitoring are integrated as standard and can be easily configured. Without protrusion, the safety field always extends to the end of the housing. This makes it easy to secure even in confined installation conditions.

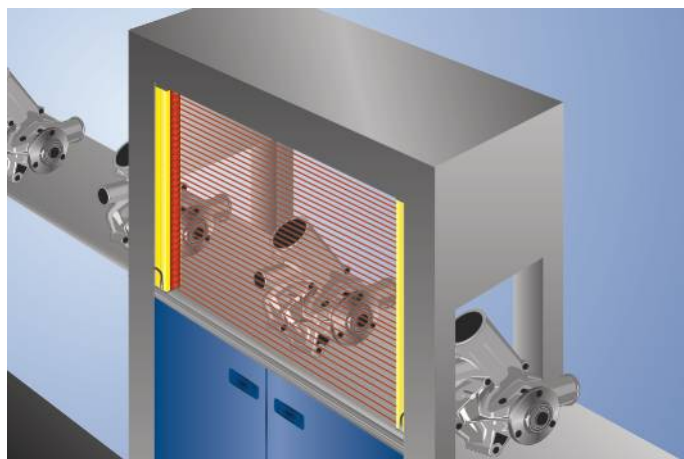

Optical Data

Range	0,25...6 m
Housing Length (L)	1810 mm
Safety Field Height (SFH)	1811 mm
Resolution	14 mm
Light Source	Red Light
Wavelength	630 nm
Opening Angle	± 2,5 °

Electrical Data

Sensor Type	Emitter
Supply Voltage	19,2...28,8 V DC
Current Consumption (U _b = 24 V)	75 mA
Temperature Range	-5...55 °C
Storage temperature	-25...60 °C
Reverse Polarity Protection	yes
Protection Class	III

Mechanical Data

Housing Material	Aluminum
Disc Material	Polycarbonate
Degree of Protection	IP65/IP67
Connection	M12 × 1; 4/5-pin
Cable Length	300 mm

Safety-relevant Data

ESPE Type (EN 61496)	4
Performance Level (EN ISO 13849-1)	Cat. 4 PL e
Mission Time TM (EN ISO 13849-1)	20 a
Safety Integrity Level (EN 61508)	SIL3
Safety Integrity Level (EN 62061)	SILCL3

Function

Finger Protection	yes
Scope of functions	Basic function

Connection Diagram No.	362
Control Panel No.	SR4
Suitable Connection Equipment No.	2 35
Suitable Mounting Technology No.	701 790 810 820

Suitable Receiver

SEMG642

Complementary Products

Path-Folding Mirror Z2UG004
Protection column with deflection mirror Z2SU003
Protection Column with Path-Folding Mirror SZ000EU215NN01
Protection Column with Protective Screen SZ000EG215NN01
Protection column with protective screen Z2SS003
Software

Ctrl. Panel

SR4

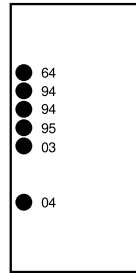
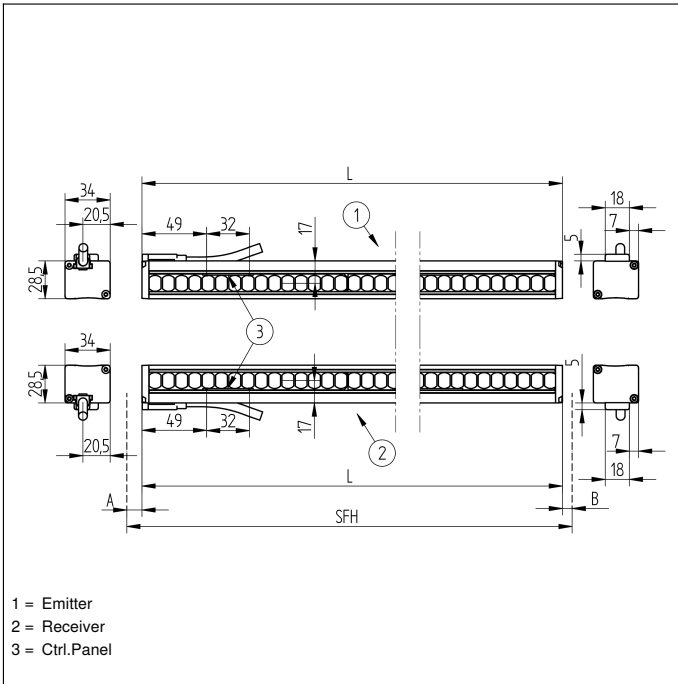

- 03 = Error Indicator
- 04 = Function Indicator
- 64 = Diagnosis/Test
- 94 = Diagnosis
- 95 = Diagnosis/Large Detection Range

